



Red Chris Deposit

Technical Report: 2010 Exploration, Drilling and Mineral Resource Update



**Red Chris Deposit
British Columbia
Liard Mining Division
Latitude 57° 42' North,
Longitude 129° 47' West
NTS map sheet 104H/12W**

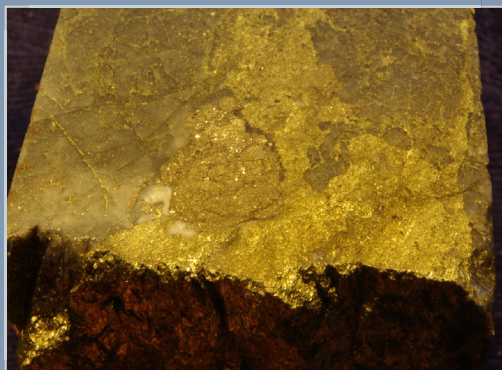

**Authors:
Greg Gillstrom, P.Eng
Steve Robertson, P.Geo**

May 19, 2010

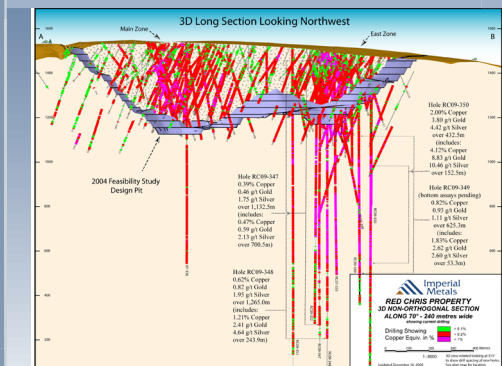

**Effective Date for the Resource Estimate:
May 3, 2010**

Imperial Metals Corporation
Suite 200, 580 Hornby Street
Vancouver BC, V6C 3B6
www.imperialmetals.com

TABLE OF CONTENTS

1	Summary	9
1.1	Summary Introduction	9
1.2	Updated Resources	14
2	Introduction and Terms of Reference	15
3	Reliance on Other Experts	18
4	Property Description and Location	19
4.1	Location and Claim Status	19
4.2	Claim Information (Mineral Tenure)	19
4.3	Permits and Agreements	24
4.3.1	Exploration Permits	24
4.3.2	Project Development, Operation and Closure Permits	24
4.3.3	Agreements	26
5	Accessibility, Climate, Local Resources, Infrastructure and Physiography	27
5.1	Northwest Transmission Line Project	28
6	History	29
6.1	Red Chris Deposit Exploration History	31
7	Geological Setting	34
7.1	Introduction	34
7.2	Tectonic Setting	36
7.3	Regional and Property Geology	37
7.4	Local Geology	40
7.4.1	Red Stock setting	40
7.4.2	Red Stock geology	42
7.4.3	Structure	43
7.4.4	Alteration	44
8	DEPOSIT TYPE	46
8.1	Classification	46
8.2	Exploration model	46
9	Mineralization	48
9.1	Introduction	48
9.2	Mineral zones	48
9.3	Dimensions, depth	48
9.4	Mineralization textures	48
10	Exploration	51

10.1	Geophysical Programs	51
10.1.1	Titan 24 Geophysical Survey	51
10.1.2	Airborne Magnetic Survey	51
10.1.3	Proton Magnetometer Survey.....	51
10.2	Composite Sampling Program	52
10.3	Camp and Infrastructure Improvements.....	52
10.4	Property Access Trail.....	54
11	Drilling.....	55
11.1	Deep Drilling - 2007	55
11.2	East Zone Deep Exploration Drilling – 2008.....	56
11.3	Footprints Regional Drilling Program	57
11.4	2009 East Zone Exploration Drilling	58
11.5	Geotechnical Drilling.....	64
12	Sampling methods and Approach.....	65
12.1	Drilling Core Handling Procedures.....	65
12.2	Down Hole Survey and Collar Coordinates.....	66
13	Sampling Preparation, Analyses and Security	67
13.1	Sampling Method, Approach and Security – 2007 to 2009	67
14	Data Verification.....	68
14.1	Pre-2007 Data	68
14.2	2007-2009 Quality Assurance and Quality Control Program	69
15	Adjacent Properties.....	71
16	Mineral Processing and Metallurgical Testing	73
16.1	2004 Feasibility Study Testing.....	73
16.1.1	Sample Selection and Metallurgical Composites	74
16.1.2	Mineralogy	76
16.1.3	2004 Metallurgical Test Program.....	77
16.1.4	Mineral Liberation Characteristics.....	77
16.1.5	Rougher and Cleaner Flotation.....	77
16.1.6	Gold Occurrence.....	79
16.1.7	Gravity Concentration Tests.....	80
16.1.8	Work Index and Ore Hardness	80
16.1.9	Metallurgical Recoveries.....	81
16.1.10	Copper Concentrate	82
16.2	Processing	84
16.3	2010 Preliminary Metallurgical Test Work on the Deep East Zone	85
17	Mineral Resource Estimate	88

17.1	Updated Mineral Resource Estimate for the Red Chris Deposit.....	88
17.2	Modeling Methodology and Resource Classification	93
17.3	Specific Gravity Modeling Calculations	97
17.4	Model Validation	98
18	Other Relevant data and Information.....	99
19	Interpretation and Conclusions	101
20	Recommendations.....	102
21	References.....	103
22	Certificates of Authors.....	106
23	Appendix A - East Zone Metallurgical Report	108

TABLE OF FIGURES

Table 1.1 - Ore Reserve Summary for the 2004/2005 mine feasibility study	10
Figure 1.1 Split Dill Core from Drill Hole RC09-350.....	12
Figure 1.2 Red Chris General Location Map.....	13
Table 1.2 Updated Red Chris Resources	14
Table 2.1 List of Standard Abbreviations.....	16
Figure 4.1 Red Chris Property Map.....	20
Table 4.1 – Red Chris Project Claims.....	21
Table 4.1 – Red Chris Project Claims Continued.....	22
Figure 4.2 Claim Map.....	23
Figure 5 Air Photo Showing the Red Chris Camp and Local Terrain.....	27
Table 6.1 – Red Chris Cumulative Exploration Summary	29
Figure 7.1 Red Chris Regional Geology.....	35
Figure 7.2 Red Chris Property Geology Map.....	38
Figure 7.3 Red Chris Property Geology Map Legend.....	39
Figure 7.4a Red Chris Deposit Geology Map.....	41
Figure 7.4b Red Chris Geological Cross Section	42
Figure 7.4c Red Chris Hydrothermal Alteration Cross Section	44
Figure 7.4d Red Chris Hydrothermal Alteration Long Section.....	45
Figure 9.1 Red Chris Split Core: High Grade Chalcopyrite.....	47
Figure 9.4 Red Chris Core Sample: Chalcopyrite in Quartz Stockwork	50
Figure 10.3 Red Chris Camp	53
Figure 10.4 New Red Chris 17km Gravel Access Trail	54
Table 11.1 2007 Drillhole Coordinates.....	55
Table 11.2 – 2008 Drillhole Coordinates.....	56
Figure 11.2 Red Chris Drilling in Progress	56
Figure 11.3 Bobcat Mounted Hydra Core Drill.....	57
Table 11.4a – East Zone Drillhole Coordinates.....	58
Figure 11.4a 3D Comparative Long Sections: 2006 Drilling vs 2009 Drilling.....	59
Figure 11.4b Red Chris 2009 Drilling Cross Section: Showing Assay Highlights	60
Table 11.4b – 2009 East Zone Drill Intercepts.....	61

Table 11.4b continued – 2009 East Zone Drill Intercepts	62
Figure 11.4c 2007 to 2009 Drillhole Collar Location Plan Map	63
Figure 12.1 Red Chris Core Storage Area	64
Figure 12.2 The Red Chris Core Shack	66
Table 14.2 QA/QC Sample Summary of Drilling Programs by Year	69
Figure 15.1 Red Chris Adjacent Property Map	72
Table 16.1a Individual Metallurgical Composite Head Grades.....	75
Table 16.1b Global Metallurgical Composite Head Grades.....	75
Table 16.1c - Metallurgical Composite Mineralogy.....	76
Table 16.1d Flotation Parameters	78
Table 16.1e Regrind Circuit versus Metallurgy.....	79
Table 16.1f Gold Recovery Partition.....	79
Table 16.1g Locked Cycle Test Results	81
Table 16.1h Copper Grade-Recovery Profile	82
Table 16.1i Copper Grade-Recovery Profile	82
Table 16.1j Copper Concentrate Analysis	83
Figure 16.2 - Red Chris Simplified Flowsheet	84
Table 16.3 Chemical and Mineral Contents	86
Figure 17.1 Red Chris 2010 Block Model.....	88
Table 17.1a Red Chris Resources: Total (Measured + Indicated) and Total Inferred.....	89
Table 17.1b Red Chris Resources: Total Measured and Total Indicated	89
Table 17.1c Red Chris Resources: Main Zone (Measured + Indicated) and Inferred.....	90
Table 17.1d Red Chris Resources: East Zone (Measured + Indicated) and Inferred	90
Table 17.1e Red Chris Resources: Gulley Zone (Measured + Indicated) and Inferred.....	91
Table 17.1f Red Chris Resources: Lower Main (Measured + Indicated) and Inferred	91
Table 17.1g Red Chris Resources: Lower East (Measured + Indicated) and Inferred	92
Figure 17.2 Red Chris 2010 Model Zones (Domains).....	92
Table 17.2a Red Chris Model Zones	93
Table 17.3a Red Chris Model Dimensions.....	93
Table 17.3b Red Chris Grade Composite Capping by Zone	94
Table 17.3c Red Chris Model Grade Capping Logic by Zone	95
Table 17.3d Red Chris Model Variography Results by Zone.....	95

Table 17.3e Red Chris Model Interpolation Search Parameters by Zone.....	96
Figure 17.4 Section 451960E; Cu Drillhole Assay Grades vs Interpolated Model Cu Grades	98
Table 18 - Ore Reserve Summary for the 2004/2005 mine feasibility study	99
Figure 18.1 2004 Feasibility Study Mine Development Concept.....	100

1 Summary

1.1 Summary Introduction

This report has been written to conform to the specification outlined in NI 43-101F1, for the Standards of Disclosure for Mineral Projects as required in National Instrument 43-101. Greg Gillstrom, P. Eng. and Steve Robertson, P. Geo. are the designated ‘Qualified Persons’ responsible for the report’s preparation in accordance with National Instrument 43-101.

This report has been prepared to update mineral resources for the Red Chris Property, and includes all new exploration drilling and geological mapping that has been done by Imperial Metals Corporation (“Imperial”) between 2007 and the beginning of 2010.

The previously published mineral reserve, mine plan, and the accompanying feasibility study have not been updated and therefore will only be referenced in this report.

The results of the 2004/2005 Red Chris Feasibility Study Report were based on:

- Conventional open pit mining
- A 30,000 tonne per day flotation mill
- Shipment of concentrates going to Pacific rim smelters
- Shipping from the B.C. port of Stewart
- Estimated 25 year mine life.

The feasibility results included Proven and Probable Reserves, metallurgical performance, capital and operating cost estimates and financial analysis. The 2004/2005 feasibility study report was written by AMEC E&C Services (“AMEC”), Vancouver, B.C. with contributions from various independent consultants as follows:

- Giroux Consultants: preparation of the resource estimate.
- Nilsson Mine Services Limited: preparation of Proven and Probable Reserve estimate, preparation of LOM mine plan, production schedule and mine capital and operating cost estimates.
- Merit Consultants International Inc.: estimation and consolidation of the project capital costs.
- G&T Metallurgical Services Limited: metallurgical test work.

Table 1.1 - Ore Reserve Summary for the 2004/2005 mine feasibility study

	Tonnes	Cu %	Au g/t	R-Cu	R-Au	R-CuEq	NMR
Proven	93,475,785	0.423	0.327	0.374	0.185	0.482	11.554
Probable	182,524,215	0.300	0.226	0.261	0.100	0.320	7.600
Total	276,000,000	0.349	0.266	0.299	0.129	0.374	8.939

Note: Metal assay values above labeled 'R-' had a recovery equation applied to them and therefore are recovered metal values. (i.e. R-Cu = Recovered Copper)

The reported ore reserves were calculated based on a \$3.75/t net smelter return cutoff. The selection of this cutoff level was based upon a pit rim determination of the ore value required for recovery of processing and general & administration onsite operating costs. Low grade quantities were segregated in the production schedule. Material between \$3.25/t net smelter return and \$3.75/t was designated as low grade one (LG1) and separated for future processing if economic conditions improved beyond the levels assumed for that study. Material with a net smelter return value above \$3.75/t but less than the applied cutoff for a particular pit phase, was designated low grade two (LG2). The LG2 material was scheduled for delivery to the East Stockpile area and then reclaimed for processing in Year 17 through Year 25.

The full 2004/2005 Red Chris Feasibility Study can be found on the Imperial Metal's website and on SEDAR.

On the Imperial website the report is available in two parts at this URL
<http://www.imperialmetals.com/s/RedChris.asp>.

On SEDAR (<http://www.sedar.com>) the report is available under Company documents for bcMetals Corporation.

The Red Chris property is located about 18 km southeast of the village of Iskut and 80 km south of Dease Lake on the Todagin Plateau in northwestern British Columbia, Canada (see figure 1.2).

The Red Chris Project is comprised of the Red Chris claims and the Red Claims. The Red Chris claims consist of 49 mineral claims covering 10,183.3 hectares. Mineral tenure number 541653 has been legally surveyed. Red Chris Development Company Ltd. ("RCDC") has a 100% interest in the Red Chris claims, subject to a 24% reversionary carried ownership interest ("RCOI") held by American Bullion Minerals Ltd. ("ABM") and a 1.8% net smelter return royalty ("NSR") by Falconbridge Limited. The 1.8% NSR can be bought down to 1% at any time prior to commencement of commercial production in consideration of \$1,000,000. RCDC is a wholly owned subsidiary of Imperial.

The Red claims cover the northern part of the project and consist of 18 mineral claims covering 7,501.5 hectares. Imperial Metals Corporation owns 100% of the Red claims (see figure 4.2).

The Red Chris porphyry copper-gold deposit is distributed along the central axis of the pervasively altered and fractured formation called the Red Stock. At the Red Chris deposit, the Red Stock is the predominant host of the mineralization. Mineralization and associated alteration are more intense adjacent to the ancestral en echelon fault system along the axis of the stock which controlled the emplacement of the stock and later altering and mineralizing hydrothermal fluids which is more typical of a shear-hosted copper-gold deposit. The Red-Chris copper-gold mineralization has good near-vertical and longitudinal continuity, controlled largely by post-mineral faulting superimposed on and along the ancestral, en echelon, central axis fault zone. Pyrite, chalcopyrite, bornite, with minor chalcocite are the principal sulphide minerals of the shallower portions of the Red Chris deposit. Minor covellite occurs as inclusions in pyrite, and molybdenite, sphalerite and galena occur locally in trace amounts. Gold, second in economic importance to copper, occurs spatially and genetically associated with the copper mineralization. In the newly discovered deep East Zone pyrite becomes significantly decreased and in places bornite becomes the dominate copper mineral.

From 1968 to 2006, the property was explored by Conwest Exploration Ltd., Great Plains Development Co., Silver Standard Mines Ltd., Ecstall Mining Limited, Texasgulf Canada, American Bullion and bcMetals Corporation (via its wholly owned subsidiary RCDC).

In 2003 and 2004 RCDC conducted an infill drilling program targeting the core in East and Main Zones where open pit mining would be expected to take place. Based on this drilling, the Red Chris Measured, Indicated and Inferred Resources were updated and RCDC commissioned AMEC to complete a Feasibility Study of an open pit mine at Red Chris. The study was published in December, 2004.

On September 8, 2006 Imperial' subsidiary CAT-Gold launched an all cash takeover bid of bcMetals Corporation, at \$0.95 per/share. bcMetals responded by adopting a poison pill which limited potential ownership of the company to 20%. Upon termination of the initial takeover bid on November 8, 2006, Imperial owned approximately 17% of bcMetals. On November 23, Taseko Mines made an offer for all outstanding shares of bcMetals, to which Imperial responded with a friendly offer of \$1.10/share, representing a 4.8% premium over Taseko's offer. A bidding war ensued, which Imperial eventually won with a final bid of \$1.70/share submitted on February 2, 2007 for total cost of \$68.4 million.

Since acquiring the Red Chris Property Imperial has conducted an aggressive exploration and drilling program, consisting of diamond drilling, geological mapping, and geophysics. During the period from 2007 to 2009 Imperial drilled 20 holes targeting deep mineralization mostly in the East Zone (hole numbers: 07-335 to RC09-354). Figure 11.4a shows a comparison of the drilling at the end of 2006 with the drilling to the end of 2009.

The highlights from the program were holes 07-335 and 09-350. Hole 07-335 was collared vertically in the core of the East zone, and graded 1.01% copper, 1.26 g/t gold its entire length of 1,024.1 metres. This extended high-grade mineralization in the East Zone down another 270m from its previously-known extent. Hole RC09-350 was collared approximately 170 metres northeast of drill hole 07-335 and returned 432.5 metres grading 2.00% copper and 3.80 g/t gold which included a 152.5m zone grading 4.12% copper and 8.83 g/t gold starting at a depth of 540.0 metres (see figure 1.1 and 11.4c).

Figure 1.1 Split Drill Core from Drill Hole RC09-350

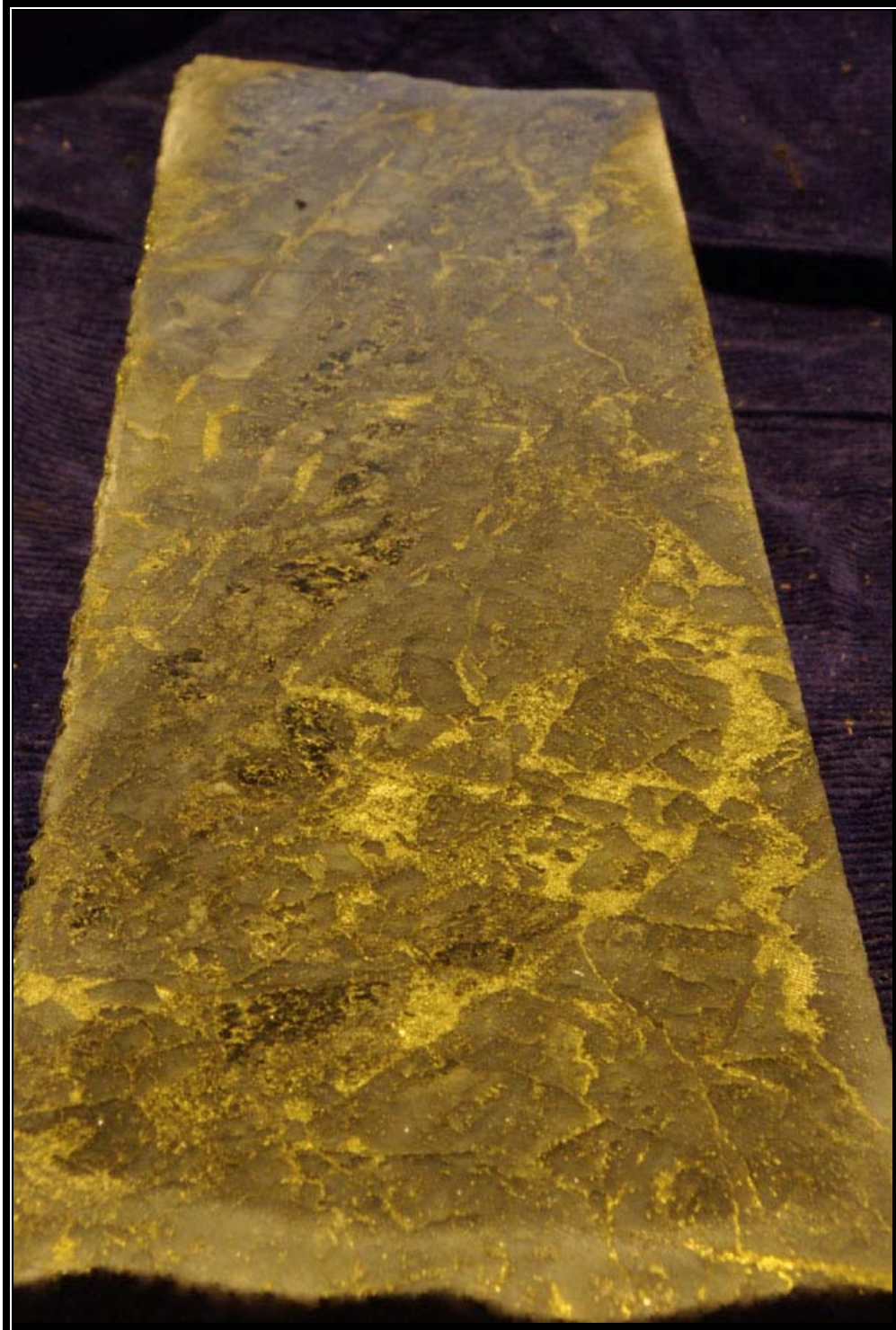
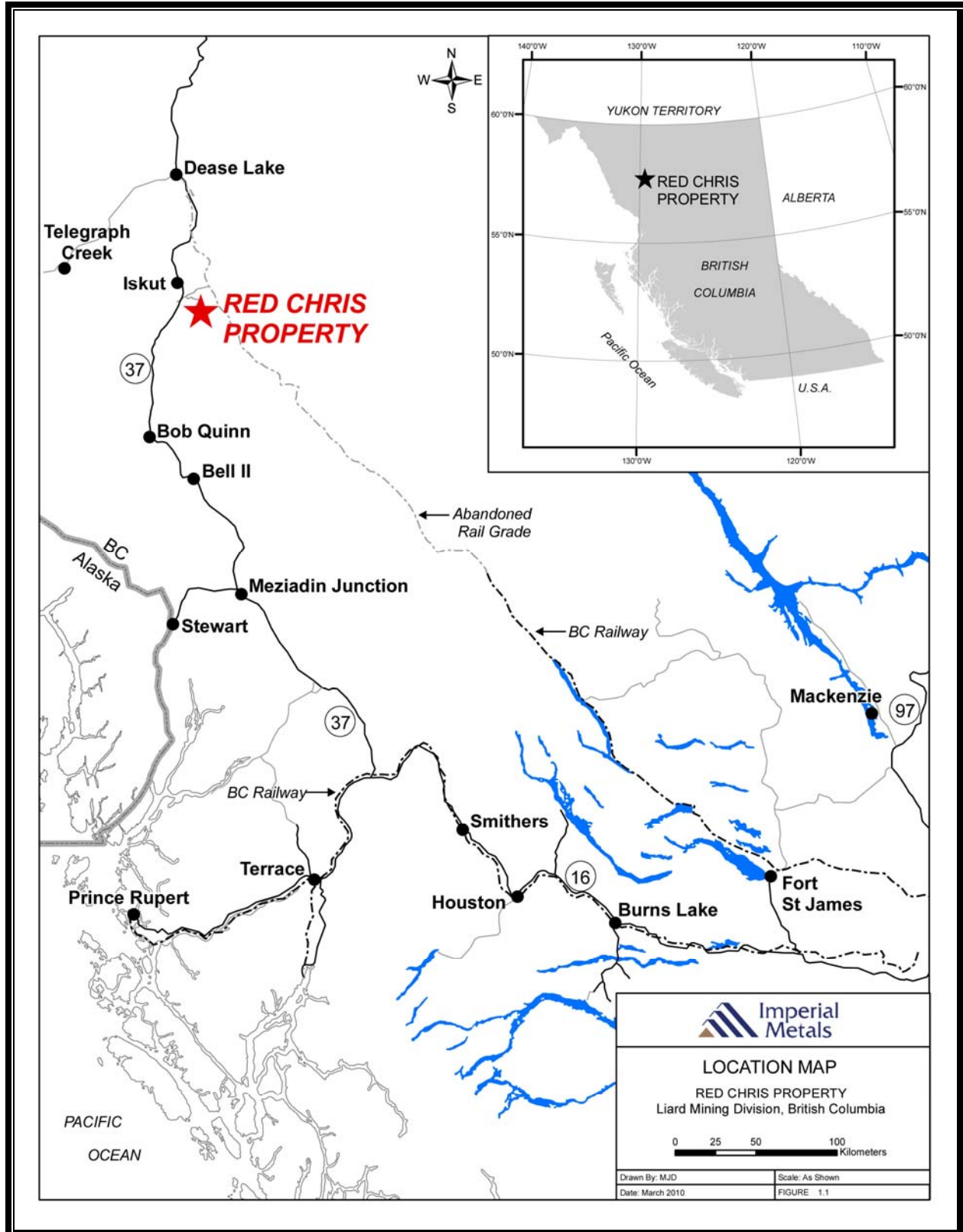

Figure 1.2 Red Chris General Location Map



1.2 Updated Resources

A new block model was constructed to update the resource calculations to include the 2007 to 2009 drilling. The assays for holes RC10-355 and RC10-360 were completed during the writing of this report and have been included. At the 0.3% copper cut-off grade used for comparative purposes, the revised resource estimate represents a 31% tonnage increase in the measured and indicated category and an 89% tonnage increase in the inferred category over the previous 2005 resource estimate. The copper and gold grades in the measured and indicated category at the 0.3% copper cut-off grade are also significantly higher, with copper grades increasing from 0.46% to 0.54%, and gold grades increasing from 0.37 to 0.55 grams per tonne. The higher grades discovered in the deeper drilling of the East zone have yielded an even more dramatic increase in the resource at higher cut-off grades. The measured and indicated resource at a 0.6% copper cut-off grade increased from 35.1 million tonnes grading 0.82% copper and 0.72 g/t gold to 86.96 million tonnes grading 0.88% copper and 1.11 g/t gold, representing a 148% increase in tonnage, a 7% increase in copper grade and a 55% increase in gold grade. (see Table 1.2 for a summary).

Table 1.2 Updated Red Chris Resources

MEASURED + INDICATED MINERAL RESOURCES						INFERED MINERAL RESOURCES				
Cut-off	Tonnes	Cu%	Au g/t	Lbs Cu	Oz Gold	Tonnes	Cu%	Au g/t	Lbs Cu	Oz Gold
	X 1,000			X 1,000	x 1,000	X 1,000			X 1,000	X 1,000
>=0.10	619,417	0.38	0.36	5,139,790	7,162	619,129	0.30	0.32	4,120,730	6,429
>=0.20	489,151	0.43	0.42	4,674,389	6,634	437,939	0.36	0.39	3,497,936	5,433
>=0.30	312,571	0.54	0.55	3,710,414	5,564	237,701	0.46	0.50	2,396,943	3,794
>=0.40	189,526	0.66	0.74	2,775,182	4,484	105,613	0.60	0.69	1,398,864	2,332
>=0.50	125,310	0.78	0.93	2,147,043	3,728	60,326	0.72	0.87	957,825	1,687
>=0.60	86,957	0.88	1.11	1,685,773	3,115	39,197	0.81	1.02	702,112	1,282
>=0.70	57,585	1.00	1.34	1,267,272	2,479	22,470	0.94	1.19	464,170	863
>=0.80	39,207	1.12	1.56	965,359	1,961	14,317	1.05	1.37	331,485	629
>=0.90	27,299	1.24	1.78	744,212	1,558	8,814	1.18	1.56	228,447	442
>=1.00	20,083	1.34	1.96	593,780	1,266	6,388	1.26	1.69	177,860	347
>=1.10	15,633	1.42	2.08	491,073	1,045	4,561	1.35	1.79	135,958	263
>=1.20	12,072	1.51	2.21	401,064	858	3,814	1.39	1.84	116,922	225
>=1.30	8,973	1.60	2.39	316,025	690	2,387	1.47	1.92	77,533	147
>=1.40	6,568	1.69	2.51	244,377	531	1,393	1.56	1.95	48,047	87
>=1.50	4,806	1.78	2.69	188,175	415	796	1.65	2.02	28,948	52

The new block model and resources have been calculated and reviewed by Art Frye, Operations Manager for the Mount Polley Mine, and by Greg Gillstrom, P. Eng. Senior Geological Engineer, who has been designated as its 'Qualified Person' for this purpose.

2 Introduction and Terms of Reference

This report has been prepared by Imperial Metals Corporation to update the previously published 2004 43-101 technical report with new exploration data and a new mineral resource estimate. The previously published mineral reserve, mine plan, and the accompanying feasibility study have not been updated and therefore will only be referenced in this report.

The scope of work for this report includes the following:

- A review of the work done on the Red Chris property previous to the 2007 Imperial Metals Corporation ownership.
- Details of improvements made at the Red Chris site.
- Details of the exploration program conducted by Imperial since 2007, including all exploration drilling, geological mapping, and a Titan geophysics survey.
- Details of the block model built in 2009/2010 and the new mineral resource results.
- Results of preliminary metallurgical testwork on the deep East Zone mineralization
- Recommendations for further work

Portions of this report relating to property details and past work history, have been taken from past reports by G.H. Giroux, J. Bellamy, J.D Blanchflower, and R. Rodger. Their contributions to the understanding and development of this property have been exceptional.

Table 2.1 List of Standard Abbreviations

Above mean sea level.....	amsl
Ampere.....	A
Annum (year).....	a
Billion years ago.....	Ga
Centimetre.....	cm
Cubic centimetre.....	cm ³
Cubic feet per second.....	ft ³ /s or cfs
Cubic foot.....	ft ³
Cubic metre.....	m ³
Day.....	d
Days per week.....	d/wk
Degree.....	°
Degrees Celsius.....	°C
Dry metric ton.....	dmt
Foot.....	ft
Gallons per minute (US).....	gpm
Gram.....	g
Grams per litre.....	g/L
Grams per tonne.....	g/t
Greater than.....	>
Hectare (10,000 m ²).....	ha
Horsepower.....	hp
Hour.....	h (<i>not</i> hr)
Hours per day.....	h/d
Hours per week.....	h/wk
Hours per year.....	h/a
Kilo (thousand).....	k
Kilogram.....	kg
Kilograms per cubic metre.....	kg/m ³
Kilograms per hour.....	kg/h
Kilograms per square metre.....	kg/m ²
Kilojoule.....	kJ
Kilometre.....	km
Kilometres per hour.....	km/h
Kilonewton.....	kN
Kilopascal.....	kPa
Kilovolt.....	kV
Kilovolt-ampere.....	kVA
Kilovolts.....	kV
Kilowatt.....	kW
Kilowatt hour.....	kWh
Kilowatt hours per tonne (metric ton).....	kWh/t
Kilowatt hours per year.....	kWh/a
Less than.....	<

Litre.....	L
Litres per minute.....	L/m
Megabytes per second.....	Mb/s
Megapascal.....	MPa
Megavolt-ampere.....	MVA
Megawatt.....	MW
Metre.....	m
Metres above sea level.....	masl
Metres per minute.....	m/min
Metres per second.....	m/s
Micrometre (micron).....	µm
Milliamperes.....	mA
Milligram.....	mg
Milligrams per litre.....	mg/L
Millilitre.....	mL
Millimetre.....	mm
Million.....	M
Million tonnes.....	Mt
Minute (plane angle).....	'
Minute (time).....	min
Month.....	mo
Ounce.....	oz
Parts per billion.....	ppb
Parts per million.....	ppm
Percent.....	%
Percent moisture (relative humidity).....	% RH
Phase (electrical).....	Ph
Pound(s).....	lb
Second (plane angle).....	"
Second (time).....	s
Specific gravity.....	SG
Square centimetre.....	cm ²
Square foot.....	ft ²
Square kilometre.....	km ²
Square metre.....	m ²
Thousand tonnes.....	kt
Tonne (1,000 kg).....	t
Tonnes per day.....	t/d
Tonnes per hour.....	t/h
Tonnes per year.....	t/a
Volt.....	V
Week.....	wk
Wet metric ton.....	wmt

3 Reliance on Other Experts

The report has been written to conform to the specification outlined in NI 43-101F1, for the Standards of Disclosure for Mineral Projects as required in National Instrument 43-101. This report was written by the technical staff of Imperial Metals with Greg Gillstrom and Stephen Robertson and as lead authors.

Greg Gillstrom P.Eng. is Senior Geological Engineer for Imperial Metals and has been responsible for the ongoing compilation of data and geological modeling of the Red Chris deposit. He is responsible for the new block model and resource statement, as well as the compilation and assembly of this report. He is designated a 'Qualified Person' for Red Chris project and is responsible for this report in accordance with National Instrument 43-101.

Stephen Robertson, P.Geo. Exploration Manager for Imperial designed and managed the 2007 to 2010 drilling programs at the Red Chris Property and is currently the Exploration Manager for the Red Chris Project. He is designated a 'Qualified Person' for Red Chris project and is responsible for this report in accordance with National Instrument 43-101.

Other major contributors to this report are as follows:

Melissa Darney, B.Sc., Geologist for Imperial, has managed the assay and data control for the Red Chris project from 2007 to present. She completed and reviewed the sections on sampling method and approach, sample preparation, analysis, and data security.

Chris Rees PhD. P.Geo., Geologist for Imperial, managed the geological mapping program at Red Chris from 2007 to 2009 and completed and reviewed the sections on geology and mineralogy.

Art Fry, Operations Manager for the Mount Polley Mine, completed the variography, calculation, and classification of the new resource block model.

Dave Smithies, P. Eng., Project Engineer for Imperial, completed the data analysis, and specific gravity work for the new resource block model.

Paul Sterling, P Eng, Metallurgist for Imperial, completed the preparation and review of the section regarding mineral processing and metallurgical testing.

Raj Anand, P.Eng. Manager, Project Development for Imperial Metals, completed the preparation and review of the section on permits and agreements.

Report graphics and maps were produced by Greg Gillstrom, Chris Rees, and Melissa Darney.

4 Property Description and Location

4.1 Location and Claim Status

The Red Chris property is located in northwest British Columbia, approximately 18 km southeast of the Iskut village, 80km south of Dease Lake, and 12km east of the Stewart-Cassiar Highway (see Figure 4.1). The nearest gravel airstrip is located in Iskut. During summer Northern Thunderbird Air regularly services the Dease Lake airport. Helicopter and fix winged charters can also be secured from the Dease Lake airport.

The Red Chris exploration site is accessible year round via a 17km gravel access trail, which was constructed in 2008. The new trail branches off at the 6km marker on the Ealue Lake road, making it a 23km trip from Red Chris camp to Highway 37 (0km on the Ealue Lake road). The access trail is predominantly travelled by pick-up trucks, but is also navigated by larger fuel trucks, flat bed trucks and semi trailers. Access to the property via the trail has significantly reduced exploration expenditures associated with helicopter reliance and has made working around the property safer (see figure 4.1).

4.2 Claim Information (Mineral Tenure)

The Red Chris Property is comprised of the Red Chris Claims and the Red Claims, which are described below. The Red Chris Deposit which has been approved for development under the British Columbia Environmental Assessment Process is located on the Red Chris Property.

The Red Chris Property consists of 49 mineral claims covering 10,183.26 hectares. Red Chris Development Company Ltd. (“RCDC”) has a 100% interest in the Red Chris Claims, subject to a 24% reversionary carried ownership interest (“RCOI”) held by American Bullion Minerals Ltd. (“ABM”) and a 1.8% net smelter return royalty (“NSR”) by Falconbridge Limited. The 1.8% NSR can be bought down to 1% at any time prior to commencement of commercial production in consideration of \$1,000,000.

The Red claims consist of 18 mineral claims covering 7,501.51 hectares. Imperial owns 100% of the Red claims (see table 4.1 and figure 4.2 for exact locations of all claims).

Figure 4.1 Red Chris Property Map

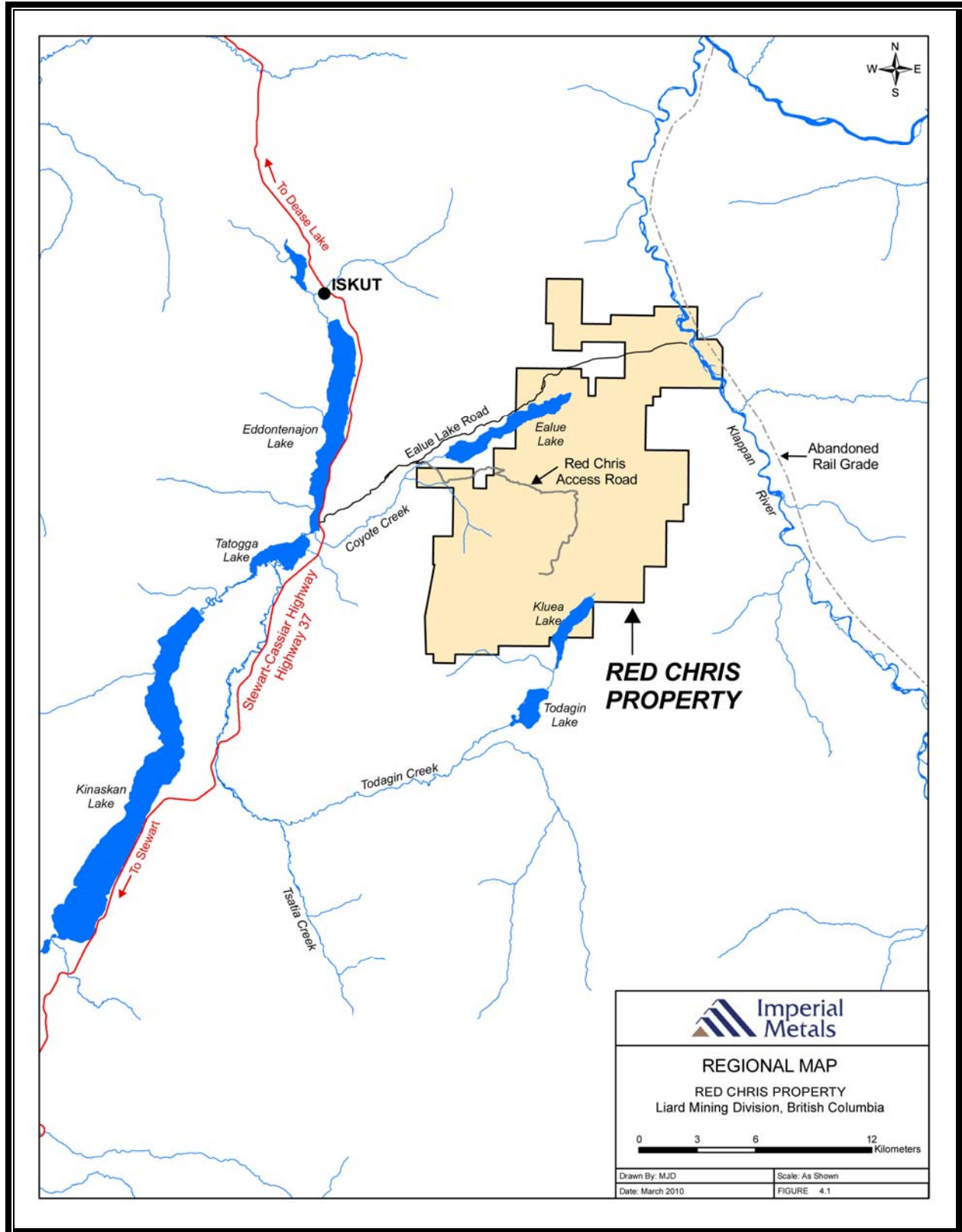

Table 4.1 – Red Chris Project Claims

Tenure Number	Claim Name	Map Number	Issue Date	Good Date	To	Area (ha)
221636	SUS NORTH	104H072	1975/jul/15	2019/jan/11		300
221682	CAPRICORN	104H072	1976/jul/07	2019/jan/11		300
221683	VIRGO	104H072	1976/jul/07	2019/jan/11		75
226822	MONEY #32	104H061	1968/sep/30	2019/jan/11		25
226823	MONEY #34	104H061	1968/sep/30	2019/jan/11		25
226824	MONEY #36	104H071	1968/sep/30	2019/jan/11		25
226825	MONEY #38	104H071	1968/sep/30	2019/jan/11		25
226826	MONEY #40	104H071	1968/sep/30	2019/jan/11		25
226844	MONEY #59	104H061	1968/sep/30	2019/jan/11		25
226845	MONEY #61	104H061	1968/sep/30	2019/jan/11		25
306685	MONEY #63	104H061	1968/sep/30	2019/jan/11		25
323340	RC-4	104H072	1994/jan/17	2019/jan/11		500
323341	RC-5	104H072	1994/jan/16	2019/jan/11		200
330898	ABM - 1	104H071	1994/sep/11	2019/jan/11		450
330900	ABM - 3	104H071	1994/sep/11	2019/jan/11		225
330901	ABM-4	104H071	1994/sep/12	2019/jan/11		500
330902	ABM - 5	104H071	1994/sep/13	2019/jan/11		300
337486	ABM 7	104H071	1995/jun/29	2019/jan/11		250
337812	ABM 11	104H072	1995/jul/08	2019/jan/11		150
394689	RED C	104H072	2002/jun/17	2019/jan/11		25
394690	RED D	104H072	2002/jun/17	2019/jan/11		25
394691	RED E	104H072	2002/jun/17	2019/jan/11		25
518181	ISKUT GREEN	104H	2005/jul/22	2019/jan/11		51.866
518182	ISKUT GREEN 2	104H	2005/jul/22	2019/jan/11		34.581
519709	EALUE	104H	2005/sep/06	2019/jan/11		155.403
523362		104H	2005/dec/02	2019/jan/11		17.29
538600		104H	2006/aug/03	2019/jan/11		345.998
541353		104H	2006/sep/15	2019/jan/11		536.5168
541358		104H	2006/sep/15	2019/jan/11		207.6848
541365		104H	2006/sep/15	2019/jan/11		415.2536
541375		104H	2006/sep/15	2019/jan/11		207.531
541379		104H	2006/sep/15	2019/jan/11		103.7379
541411		104H	2006/sep/15	2019/jan/11		414.8534
541436		104H	2006/sep/15	2019/jan/11		311.1278
541437		104H	2006/sep/15	2019/jan/11		34.6005
541438		104H	2006/sep/15	2019/jan/11		207.5574
541439		104H	2006/sep/15	2019/jan/11		138.3333

Table 4.1 – Red Chris Project Claims Continued

Tenure Number	Claim Name	Map Number	Issue Date	Good Date	To	Area (ha)
541534		104H	2006/sep/18	2019/jan/11		276.5449
541541		104H	2006/sep/18	2019/jan/11		103.6848
541620		104H	2006/sep/19	2019/jan/11		138.3001
541621		104H	2006/sep/19	2019/jan/11		484.2657
541622		104H	2006/sep/19	2019/jan/11		311.1362
541623		104H	2006/sep/19	2019/jan/11		155.5856
541652		104H	2006/sep/19	2019/jan/11		207.6092
541653		104H	2006/sep/19	2019/jan/11		691.7355
541654		104H	2006/sep/19	2019/jan/11		103.7108
541657		104H	2006/sep/19	2019/jan/11		207.4908
541721		104H	2006/sep/20	2019/jan/11		363.2123
588392		104H	2008/jul/17	2019/jan/11		432.6446
394682	RED 10	104H082	2002/jun/18	2019/jun/10		375
503400		104H	2005/jan/14	2019/jun/10		397.364
503403		104H	2005/jan/14	2019/jun/10		569.871
503405		104H	2005/jan/14	2019/jun/10		379.252
503406		104H	2005/jan/14	2019/jun/10		620.809
503408		104H	2005/jan/14	2019/jun/10		414.201
503410		104H	2005/jan/14	2019/jun/10		621.448
503412		104H	2005/jan/14	2019/jun/10		517.194
503413		104H	2005/jan/14	2019/jun/10		449.158
503415		104H	2005/jan/14	2019/jun/10		465.897
503416		104H	2005/jan/14	2019/jun/10		465.823
503418		104H	2005/jan/14	2019/jun/10		155.372
503422		104H	2005/jan/14	2019/jun/10		379.502
503424		104H	2005/jan/14	2019/jun/10		275.77
503425		104H	2005/jan/14	2019/jun/10		379.89
503426		104H	2005/jan/14	2019/jun/10		259.17
503427		104H	2005/jan/14	2019/jun/10		345.004
660623	LIMY	104H	2009/oct/27	2010/oct/27		430.7912

Figure 4.2 Claim Map

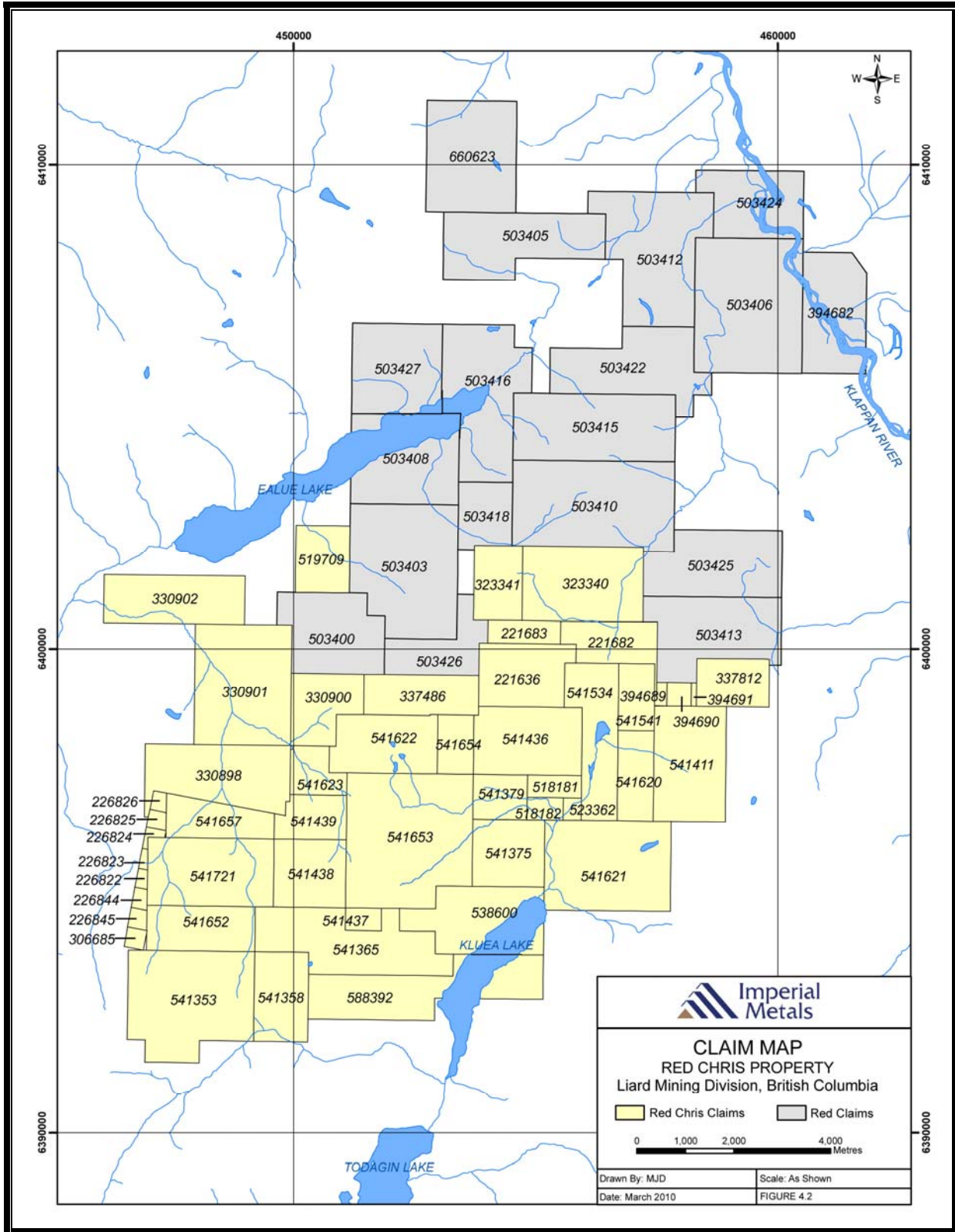

4.3 Permits and Agreements

Red Chris commenced its environmental assessment process by submitting an application in 2004 to both the government of British Columbia and Canada. The Provincial Environmental Assessment process follows the British Columbia Environmental Assessment Act (“BC EAA”) and the Federal Environmental Assessment follows the Canadian Environmental Assessment Act (“CEAA”) process.

The Red Chris (BCEAA) Certificate was issued in August 2005. Federal approval for the Red Chris Project under the CEAA was received in May 2006. The federal approval was subsequently challenged by a third party; however a decision by the Supreme Court of Canada on January 21, 2010 upheld the federal approval which has allowed mine permitting and development to proceed.

4.3.1 Exploration Permits

Since the acquisition of bcMetals by Imperial Metals Corporation in 2007, work at the Red Chris site (exploration and geotechnical investigations for site and tailings impoundment) has been conducted under mineral exploration permits issued by the Ministry of Energy Mines and Petroleum (MEMPR). In 2008, an access trail to the project site was also constructed under the exploration permit.

The exploration permit was obtained to conduct the following work:

- Exploration drilling as per submitted yearly work program
- Building an exploration trail for safer and environmentally improved access for drilling
- Geotechnical investigation for the plant site and the tailings impoundment areas.

4.3.2 Project Development, Operation and Closure Permits

RCDC submitted its draft Terms of Reference for the Mines’ Act Permit Application in October 2009 and met with Northwest Mine Development Review Committee in December 2009 and in March 2010. The Terms of Reference (“TOR”) are finalized.

The BC Government is in the process of streamlining the overall permitting process and is proceeding with asynchronous permitting approach. The new system will have all permits required from the various ministries of the Province to be synchronized with the Mines Act Permit Application.

The following permits, approvals, licenses and leases will be required for the Red Chris Mines’ development, operation and closure:

BC MEMPR

- Mines’ Act Permit
- Permit pursuant to *Mining Right of Way Act*
- Mining Lease

BC MOE

- Effluent Discharge Permit, Refuse, Air, Special Waste, Sewage Registration
- Water License(s)
- Permit pursuant to *Wildlife Act*

MOFR

- Occupant License to Cut
- Special Use Permit (for the access road segment off the mineral claims)
- Burning

ILMB

- License of Occupation (for the power line off the mineral claims)

MOTI

- Permit to Connect to a Public Highway
- Permit to install the power line if located in a road right of way

TCA, Archaeology Branch

- Alteration Permit (Section 12, Heritage Conservation Act) OR Systematic Data Recovery (Section 14, HCA) in some areas

Northern Health Authority

- Permits pursuant to the Health Act, Food Premise Regulation, Industrial Camps Health Regulation
- Permit pursuant to *Drinking Water Protection Act*

Federal Authorizations

- DFO – Federal *Fisheries Act* Authorization
- EC – MMER Schedule 2 Designation for the Tailings Impoundment Area
- NRCan – *Explosives Act* Authorization (for explosives manufacturing)

4.3.3 Agreements

Red Chris Development Company Ltd. (“RCDC”) has a 100% interest in the Red Chris Claims, subject to a 24% reversionary carried ownership interest (“RCOI”) held by American Bullion Minerals Ltd. (“ABM”) and a 1.8% net smelter return royalty (“NSR”) by Falconbridge Limited. The 1.8% NSR can be bought down to 1% at any time prior to commencement of commercial production in consideration of \$1,000,000.

The RCOI is an interest which gives the holder the right to receive payment after commencement of commercial production on the Red Chris Project and after all costs incurred on or in connection with the Project have been repaid in full. The RCOI becomes a net 24% working interest after commencement of commercial production on the Red Chris Property and becomes assessable for a 24% share of costs and other royalty burden upon commencement of commercial production. RCDC is entitled to receive 100% of all revenues, until all costs incurred on or in connection with the project have been repaid in full.

5 Accessibility, Climate, Local Resources, Infrastructure and Physiography

The Red Chris exploration site is accessible year round via a 17km gravel access trail, which was constructed in 2008. The new trail branches off at the 6km marker on the Ealue Lake road, making it a 23km trip from camp to Highway 37 (0km on the Ealue Lake road). The access trail is predominantly travelled by pick-up trucks, but can also be navigated by larger fuel trucks, flat bed trucks and semi trailers. Access to the property via the trail has significantly reduced exploration expenditures associated with helicopter support and has made access to the property safer.

Figure 5 Air Photo Showing the Red Chris Camp and Local Terrain

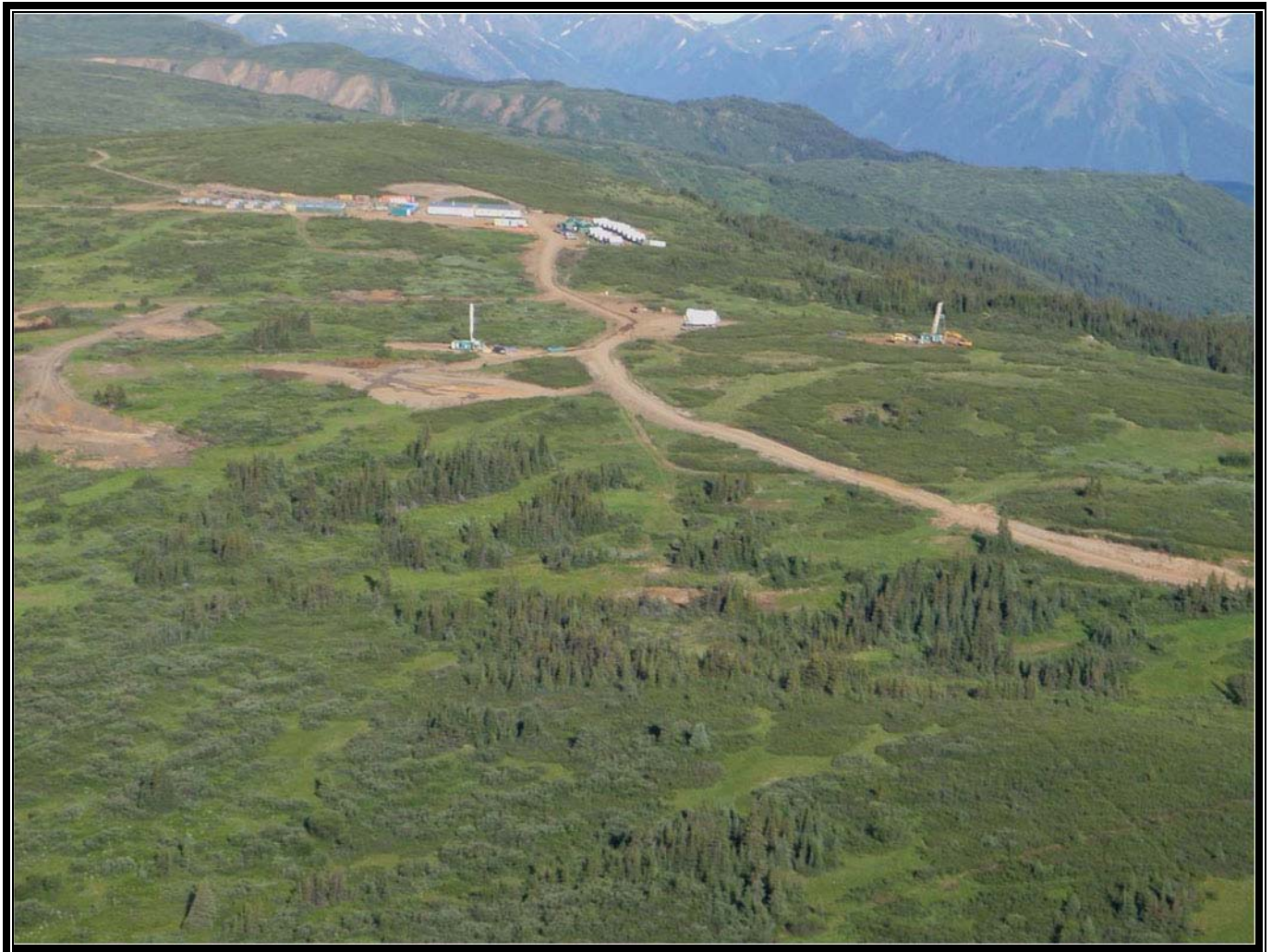

In summer Northern Thunderbird Air regularly services the Dease Lake airport. Aside from the regular flight schedule, helicopter and fix winged charters can be secured from the Dease Lake airport. The Red Chris property is located approximately 18 km southeast of the Iskut gravel airstrip located in the village of Iskut (see Figure 4.1).

The Red Chris property is situated on the eastern portion of the Todagin upland plateau which forms a subdivision of the Klastine Plateau along the northern margin of the Skeena Mountains. Elevations on the plateau are typically $1,500 \pm 30$ m with relatively flat topography broken by several deep creek gullies (see figure 5). Bedrock exposure is confined to the higher-relief drainages and along mountainous ridges. The majority of the property is covered by several metres of glacial till. Vegetation on the plateau consists of scrub birch and willow, grasses, and mosses. Within the creek valleys, are several varieties of conifer and deciduous trees including balsam, fir, cedar, spruce, and aspen. The project area lies in a region of moderate annual precipitation with an average of 530 mm total annual precipitation which is more or less evenly distributed throughout the year, with April to May receiving the least and August to December the most. Temperatures vary from a low of -21°C in January to a high of 9°C in July with temperature extremes ranging from -50°C to 30°C .

5.1 Northwest Transmission Line Project

Development of the Red Chris Mine is contingent upon the availability of electric power. The Provincial and Federal governments have committed to provide funding for a powerline from Terrace to Bob Quinn (Northwest Transmission Line (“NTL”) Project, which is now under review through the BC environmental assessment process. Assuming that the NTL is approved and constructed Imperial will be responsible for extending powerline service sufficient to meet its needs from Bob Quinn to Tatogga and from there to the Red Chris Mine. The powerline extension along Highway 37 requires approval through an amendment of the Red Chris EA Certificate and will also require a permit from the BC Ministry of Transportation and Infrastructure (MOTI) to allow development within the Highway 37 Right-of-Way (see figure 1.2 and 4.1).

6 History

Below is a cumulative history of all the exploration that has occurred on the Red Chris Property to date.

Table 6.1 – Red Chris Cumulative Exploration Summary

Owner	Geochemical Samples	Geophysical Samples	Drilling/Trenching	References/ARIS #
Conwest Exploration Ltd.			X-Ray drilling program not defined	B.C.M.M. Annual Report, 1956.
Great Plains Development Company of Canada Ltd.	Survey not well defined, roughly 534 B-horizon soil, and 8 rock samples			Reynolds (1969) / 02164&02165
Great Plains Development Company of Canada Ltd.			2 DDH (309m), 70-1 to 70-2; trenching program not defined	Referenced in Giroux et al. 2002, Work conducted in 1970
Silver Standard Mines Ltd.	B-horizon samples, survey not defined		Trenching (457m)	Referenced in Giroux et al. 2002, Work conducted in 1971
Great Plains Development Company of Canada Ltd.		12km IP survey	8 DDH (922m), 72-1 to 72-8	Referenced in Panteleyev 1973, Work conducted in 1972
Texasgulf Canada Ltd. (1)	Overburden program not defined	IP survey not defined, 6km proton magnetometer survey	67 DDH (12,284m) 23/49-67 core logs; 44 PDH (3,173m), holes 1-44; trenching (558m)	Leitch, Phil and Newell (1976) / 06111, Work conducted further referenced in Forsythe (1977) / 06489. Cumulative work from 1973-1976
Texasgulf Canada Ltd. (1)	153 overburden samples	20km IP survey		Forsythe (1977) / 06489
Texasgulf Canada Ltd. (1)			5 DDH (391m), 68-72 core logs	Newell (1978) / 06872
Texasgulf Canada Ltd. (2)			2 DDH (626m), 73-74 core logs	Peatfield (1980) / 08994
Dryden Resource Corp.	92 B-horizon soil, 78 silt and 24 rock samples			Mehner (1991) / 21204
Dryden Resource Corp.	228 B-horizon soil, 26 silt and 5 rock samples			Mehner (1991) / 21957
Dryden Resource Corp.	170 B-horizon soil, 12 silt, and 15 rock samples		Minor hand trenching program not defined	Tupper (1993) / 22909
American Bullion Minerals Ltd. (3)			13 DDH (4,562m), 75-87 core logs Appendix B	Roberts (1994) / 23534
American Bullion Minerals Ltd. (3)	547 B-horizon soil samples	74km ground mag., 72km IP and 26km EM	45 DDH (16,855m) 88-99 core logs Appendix G, 100-116 core logs Appendix H, 117-132 core logs Appendix I)	Blanchflower (1995) / 23834

American Bullion Minerals Ltd. (3)	290 A, B or C soil and 5 rock samples		112 DDH (36,830m), 133-164 core logs Appendix B, 164-194 core logs Appendix C, 195-220 core logs Appendix D, 220-244 core logs Appendix E; 3 (59m) geotechnical holes	Blanchflower (1996) / 24453
BC Metals (4)			49 DDH (16,591m), 248-274 core logs Appendix B, 275-295 core logs Appendix C; 17 (2,500m) geotechnical holes Appendix D, 24 geotechnical test pits Appendix D	Bellamy (2004) / 27479
BC Metals (4)		4.6km seismic and 6.5km EM survey	25 DDH (6,927m), 296-320 holes	Referenced in Ferreira 2008 / 29900. Work conducted in 2004. Hillmand and Yarham 2004 (Geophysics)
BC Metals (4)			14 DDH (4,679m), 321-334 holes	Referenced in Ferreira 2008 / 29900. Work conducted in 2006.
Imperial Metals Corp.		Proton magnetometer survey over deposit	6 DDH (4,835m), see report 335-340 core logs	Ferreria (2008) / 29900
Imperial Metals Corp. (5)	11 rock samples		3 DDH (2,220m) see report 341-343 core logs	Ferreira (2009) / Not Released, see internal report
Imperial Metals Corp. (5)	42 rock samples, 491 ICP composite samples (comprised of individual 2,500 samples)	31km Titan IP survey; 1,295 km Aeroquest airborne magnetic survey; extensive proton magnetometer survey over Titan grid, property roads/trails and areas of interest	11 DDH (14,172m), 344-354 core logs; 138 DDH (2,440m) Footprints Project; 8 DDH (240m) geotechnical holes Appendix.	MacKenzie and MacPherson, internal report (2010)
Total =	1861 soil samples, 153 overburden samples, 97 rock samples, 116 silt samples, 491 composite samples	135km IP, 32km EM, 1,295 km airborne magnetic, extensive ground mag. coverage	356 DDH (122,203m), 44 PDH (3,173m), 138 DDH Footprints Project (2,440m), 28 geotechnical holes (2,799), trenching (+1,015m), 24 test pits	

(1) Great Plains Development Company of Canada Ltd. (20%) and Silver Standard Mines Ltd. (20%) claims optioned by Texasgulf Canada Ltd. (60%, previously Ecstall Mining Ltd.) and operated by Texasgulf Inc.

(2) Norcan Energy Resources (previously Great Plains Development Company of Canada Ltd.) and Silver Standard Mines Ltd. claims optioned by Texasgulf Canada Ltd. and operated by Texasgulf Inc.

(3) American Bullion bought out Falconbridge (60%, a Noranda subsidiary) and Norcen Energy (20%), leaving it the principal operator and Teck Corp. the minority owner.

(4) American Bullion optioned (30%) the property to the majority owner and operator Red Chris Development Company a subsidiary of beMetals (optioned Teck Cominco's 20%, yielding 70% ownership)

(5) Claims owned and operated under Red Chris Development Company, a subsidiary of Imperial Metals Corp.

6.1 Red Chris Deposit Exploration History

This section has been largely taken from the Giroux et al, 2002 and 2004 reports on the Red Chris Project.

The first recorded exploration of the project area occurred in 1956 when Conwest Exploration Limited staked the Windy claims to cover prominent limonitic gossans on the Todagin Plateau. The showings reported (B.C.M.M. Annual Report, 1956) consisted of a large oxidized area with small amounts of azurite and malachite. Work consisted of a limited amount of open-cutting and pack-sack X-Ray drilling.

In September 1968, Great Plains Development Co. of Canada staked the Chris and Money claims to cover the headwaters of a stream in the western portion of the present project area, based on a strong copper anomaly in stream sediments. Over the next 2 years Great Plains conducted geological (8 rock samples) and geochemical (534 B-horizon samples) surveys followed by two diamond drill holes in 1970 totalling 309 m. One of the holes (70-2) intersected 0.25 % Cu over 73 metres. During the next two years, additional surveys were completed including geologic mapping, ground magnetic and induced polarization surveys, followed by the drilling of eight diamond drill holes in 1972, totalling 922 m. These holes intersected weak pervasive (hypogene) alteration controlled by fracturing with low supergene copper mineralization near surface (Panteleyev, 1973).

In 1970, Silver Standard Mines Ltd. staked the Red and Sus claims to the north and east of the Chris claim group. In 1971, Silver Standard conducted geologic mapping and soil geochemical surveys over the claims and tested anomalies with bulldozer trenches (457m) near the common boundary between the Red and Chris claims. Two trenches exposed low-grade copper mineralization in intrusive rocks. Ecstall Mining Limited (which later became Texasgulf Canada Limited, the Canadian subsidiary of Texasgulf Inc.), optioned the Silver Standard claims in 1973 and drilled 14 percussion holes totalling 914 m, of which half intersected low grade copper mineralization.

In 1974, Texasgulf Canada Ltd. formed an agreement with Silver Standard and Great Plains to acquire an option on 60 per cent of the combined Red and Chris groups of claims and paying 80% of costs with Silver Standard and Great Plains both retaining 20 per cent.

During the years from 1974 to 1976, Texasgulf drilled a total of 67 diamond drill holes (12,284 m) and 30 percussion holes (2,261 m). During the 1978 and 1980 field seasons, Texasgulf drilled an additional 7 shallow core holes totalling 1,017 m to test for near-surface copper-gold mineralization. (Newell and Peatfield, 1995). Property-wide geological, geochemical (153 overburden samples), and geophysical surveys (20km IP) were also completed during this time. An overburden drill was utilized to test bedrock geochemistry in poorly exposed areas of the property. The results of this program outlined an area 3.4 km long, striking east-northeast, with multiple anomalies greater than 500 ppm copper. This anomalous copper zone effectively outlines the limits of the Red intrusive stock. Magnetometer surveys delineated the northern intrusive contact of the Red Stock with volcanics but could not discriminate between the various intrusive lithologies or the Bowser Lake Group of clastics to the south.

As a result of the Texasgulf exploration, two coalescing east-north-easterly trending zones of copper-gold mineralization named the Main and East zones were outlined. The mineralization was described as pyrite, chalcopyrite, and lesser bornite occurring spatially with zones or quartz vein stockwork near the centre of the Red intrusive stock. The estimated resource in 1976 at a 0.25% Cu cut-off was 34.4 million tonnes with an average grade of 0.51% Cu and 0.27 g/t Au to a depth of 270 m in the Main Zone and 6.6 million tonnes with average grade of 0.83% Cu and 0.72 g/t Au to a depth of 150 m in the East Zone (Newell and Peatfield, 1995).

No exploration was done on the property in the period 1981 to 1994. A series of corporate takeovers and reorganizations in January, 1994 resulted in the ownership of the property divided amongst Falconbridge (60%), Norcen Energy (20%), and Teck Corporation (20%). American Bullion Minerals Ltd. acquired an 80% interest in the property in early 1994 with Teck Corporation retaining the remaining 20%. American Bullion retained Mark Rebagliati to review and evaluate the exploration completed by previous owners. Rebagliati estimated a possible resource at a 0.20 % Cu cut-off of 136 million tonnes averaging 0.38 % Cu and 0.25 g Au/t. He estimated a higher grade core containing 37 million tonnes averaging 0.67% Cu and 0.45 g Au/t. Rebagliati recommended 15,000 m of diamond drilling to upgrade and expand the higher grade core zones and explore the remainder of the property (Rebagliati, 1994).

During the 1994 field season, American Bullion completed mineral claim staking, land surveying, line cutting, soil geochemistry (547 B-horizon), geophysics (including 74km ground magnetic, 26km V.L.F. EM, and 72km induced polarization surveys), camp and core logging facility construction, HQ and NQ diamond drilling totalling 21,417 m in 58 holes, core sample assaying, acid base accounting studies, base-line environmental studies, a mineral resource estimate, petrographic and metallurgical studies, and documentation. The programs were completed between June and November, 1994 at a cost of CAN \$4.2 million.

Drilling completed in 1994 extended the lateral dimensions for mineralization in a north-south direction and extended the known copper-gold mineralization over vertical distances of up to 400 m. Geochemical and geophysical surveys extended the mineralization to the west to include the 600 by 600 m Far West zone and the 700 by 400 m Gully zone.

Based on the additional 1994 drill data the measured + indicated resource was estimated at 181 million tonnes averaging 0.4% Cu and 0.31 g Au/t at a 0.2% Cu cut-off (Giroux, 1995). In this report, terms of proven, probable, and possible were used that under 43-101 Guidelines would conform to Measured, Indicated, and Inferred. An additional 139 million tonnes averaging 0.35% Cu and 0.28 g Au/t at the 0.2% Cu cut-off was classed as inferred. This resource, estimated by ordinary kriging of 30 x 30 x 15 m blocks, was compiled and estimated within a 1,300 x 200 m area to depths of between 1,050 to 1,530 m A.M.S.L.

The 1995 exploration program (112 holes totalling 36,770m) successfully increased the geological resources of the Red Chris deposit across the width of the Red stock and over a 400-metre strike length west of the known mineralization. Significant near surface copper-gold mineralization was also discovered at the Gully and Far West zones. As of November, 1995, the property had been tested by a

total of 244 diamond and 44 percussion drill holes, or 74,782 metres of drilling. Drill program was supplemented by a 290 sample geochemical survey.

In 2003, bcMetals conducted an infill drilling program totalling 16,591m in 49 drillholes. This resulted in updated measured, indicated, and inferred resourced calculations which were released in the NI 43-101 Update Report dated February 16, 2004.

The infill drill program completed in 2004 consisted of a total of 6,927 m in 25 diamond drill holes. Of these holes 10 targeted the Main Zone, 4 targeted the saddle zone between the Main and East zones, 6 tested the East zone and 5 condemnation holes were drilled to the north east of the East Zone (RCDC Technical Report, 2007). This resulted in a reinterpretation of the geologic model upon which the resource estimation was based. As a result, the mineralized unit was re-modeled as a single unit, whereas prior to 2004, the Main Zone and East Zone had been separated, with inner and outer mineralized shells. Drill program was supplemented by a 4.6km seismic and 6.5km EM geotechnical program designed to further investigate the tailing impoundment area.

Exploration in 2006 consisted of 14 drillholes for a total length of 4679m. This consisted of 7 holes in the Gully Zone and 2 geotechnical holes 300m to 600m northeast of the pit limit, in the vicinity of the then-proposed mill site. In addition, 5 holes were drilled within the East and Main zones for due diligence and verification purposes under the terms of a joint venture agreement between bcMetals and the Global International Jiangxi Copper Company Ltd, which had recently been announced for the development of Red Chris.

On September 8, 2006 Imperial's subsidiary CAT-Gold launched an all cash takeover bid of bcMetals Corporation at \$0.95 per share. bcMetals responded by adopting a poison pill which limited potential ownership of the company to 20%. Upon termination of the initial takeover bid on November 8, 2006, Imperial owned approximately 17% of bcMetals. On November 23, 2006 Taseko Mines Limited made an offer to purchase all outstanding shares of bcMetals, to which Imperial responded with a friendly offer of \$1.10/share, representing a 4.8% premium over Taseko's offer. A bidding war ensued, which Imperial eventually won with a final bid of \$1.70/share submitted on February 2, 2007 for total cost of \$68.4 million.

7 Geological Setting

7.1 Introduction

Sources of information on the regional geological setting of the Red-Chris deposit are primarily provincial and federal geological survey reports and open files, or references therein. The most recent work is by Ash and others who produced 1:50,000 scale maps of the geology and mineral occurrences in the Tatogga Lake area for the British Columbia Geological Survey, along with accompanying reports (Ash *et al.*, 1995, 1996, 1997a,b). The regional geology map in Figure 7.1 is based on these works, with additional geology from Geological Survey of Canada open file maps by Read (1984, 1990). A comprehensive report on the geology of the northern Bowser Basin by Evenchick and Thorkelson (2005) is the best recent reference for this element of the regional geological framework.

Geology pertaining to the Red-Chris porphyry copper-gold deposit itself (see also Section 9) has been adapted in large part from a major report on Red-Chris by Giroux *et al.* (2002). Notable, earlier published work on Red-Chris includes Newell and Peatfield (1995) and Baker *et al.* (1997).

Figure 7.1 Red Chris Regional Geology

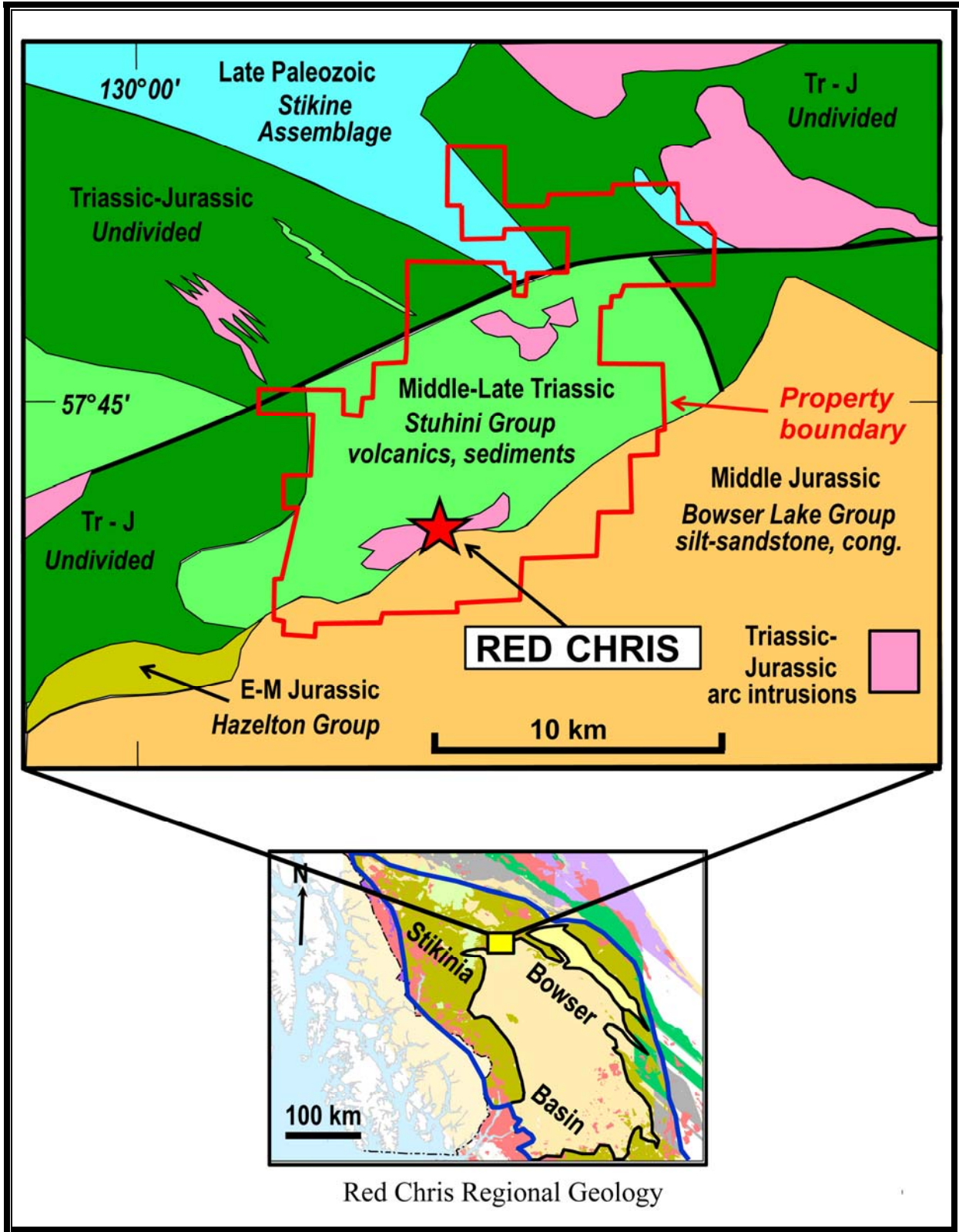

Red Chris Regional Geology

7.2 Tectonic Setting

Red-Chris is situated in northern British Columbia within the accreted Stikinia terrane of the Canadian Cordillera (see figure 7.1). This terrane forms a broad northwesterly trending belt in the centre of the Cordillera from southern British Columbia into southwestern Yukon, and forms a major part of the 'Intermontane Belt'. Stikinia is dominated by early Mesozoic island-arc volcanic strata and related intrusions, overlying a basement of Carboniferous, strongly deformed metasedimentary and metavolcanic rocks known as Stikine Assemblage. The Mesozoic arc rocks are the Middle to Late Triassic Stuhini Group, overlain by the Early and Middle Jurassic Hazelton Group. The Stuhini Group consists of basinal sedimentary rocks, and submarine augite or hornblende-phyric basaltic volcanics and volcanoclastics. The Hazelton Group is a diverse assemblage of bimodal, basaltic to rhyolitic subaerial and submarine volcanic rocks and related sediments, and may be a composite of two subparallel arcs and an intervening rift-basin(s) (Evenchick and Thorkelson, 2005). There was probably a short hiatus in the earliest Jurassic between the Stuhini and Hazelton groups. Regionally, both groups may host significant mineral deposits related to Late Triassic and/or Early to Middle Jurassic intermediate intrusions, or to volcanogenic hydrothermal activity. Red-Chris is in a Late Triassic intrusion in the Stuhini Group.

Both the Stuhini and Hazelton assemblages formed in oceanic arcs outboard of the North American paleocontinental margin (now represented by the Omineca Belt), in response to east-directed, and possibly west-directed, subduction. Hazelton arc(s) formation was complicated by interarc extension and subsidence related to the migration and docking of the Stikinia microplate against the North American margin in the Early to Middle Jurassic.

Stikinia's accretion involved the inboard trapping of oceanic crust represented by the Cache Creek terrane, now interposed between Stikinia and the Omineca Belt. Subsequent crustal shortening thrust the Cache Creek terrane southwestwards onto Stikinia, producing a marine to non-marine flexural basin ('Bowser Basin') on its southwestern front into which chert clast-rich sediments derived from the Cache Creek Group were deposited, in the form of the Middle Jurassic to Early Cretaceous Bowser Lake Group. All units were affected by Early to Late Cretaceous tectonic activity of the Skeena Fold Belt.

7.3 Regional and Property Geology

The southern half of the Red-Chris property (figure 7.2), containing the Red-Chris deposit, lies on a broad physiographic plateau called the Todagin Plateau. This plateau is underlain mainly by the Stuhini Group, flanked on the southeast across a fault by the younger Bowser Lake Group. The Hazelton Group occurs just beyond the far southwest of the property, overlying the Stuhini Group probably by an angular unconformity. Bedding in the Stuhini Group is typically steep and variable, likely due to a regional deformation event around the Triassic-Jurassic boundary (Evenchick and Thorkelson, 2005). Regional considerations suggest the Stuhini stratigraphy generally faces west or southwest in the region. Jurassic strata of the Bowser Lake Group (and underlying uppermost Hazelton) have gentle to moderate dips between southeast and southwest resulting from Skeena Fold Belt deformation.

The northern half of the property is largely in lower topography, sloping towards the broad Klappan River plain, where the geology is less well known due to limited rock exposure. However, the better exposed ridges above the Ealue Lake valley are underlain by Stuhini Group and an Early Jurassic intrusion (Ealue Stock) to the east of the lake, and a mixture of Stikine Assemblage and Stuhini and Hazelton groups on the ridges to the northwest and north. A northeast-trending fault is inferred to follow the trace of Coyote Creek and the Ealue Lake valley. It continues to the east for an additional 30 kilometres where it has been designated the McEwan Creek Fault with a south side-down movement sense.

Intrusive rocks in the region range from large composite intrusions or stocks, to dikes a few metres in thickness. A swarm of Early Jurassic granitic dikes north of Ealue Lake trends NW-SE. Southeast of the lake, on the Red-Chris property, dikes generally trend between ENE and WNW. They range in age from Late Triassic to Early Jurassic, although some may be younger. Composition is typically medium to coarse grained monzodiorite. The largest intrusion here is the Red Stock, which hosts the Red-Chris deposit, and is described under 'Local Geology', below.

Regional metamorphic grade on the property is low (except in the Stikine Assemblage), no higher than lower greenschist or subgreenschist. Hornfelsing related to contact metamorphism around larger intrusions may be present. The Bowser Lake Group is unmetamorphosed.

Figure 7.2 Red Chris Property Geology Map

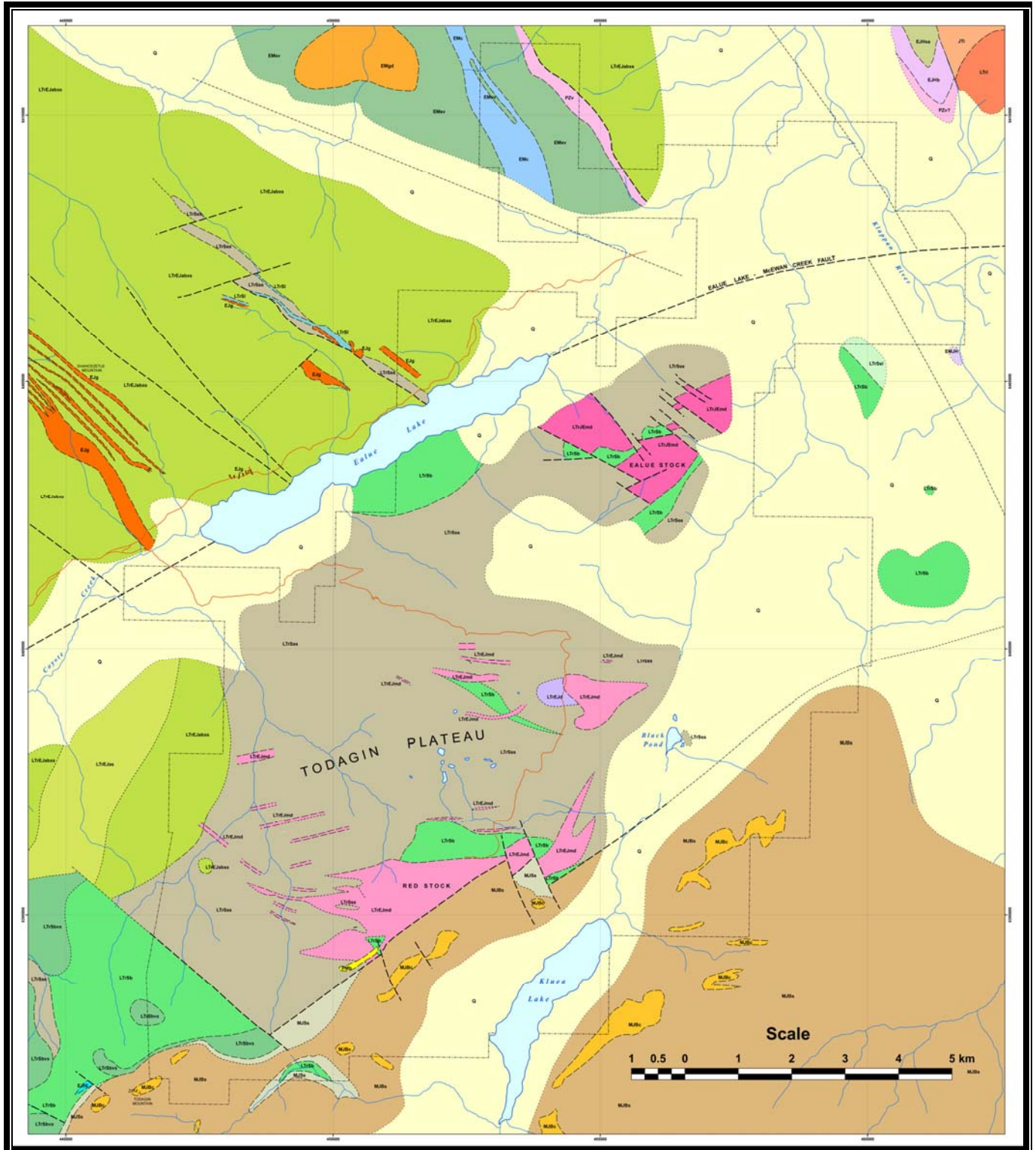
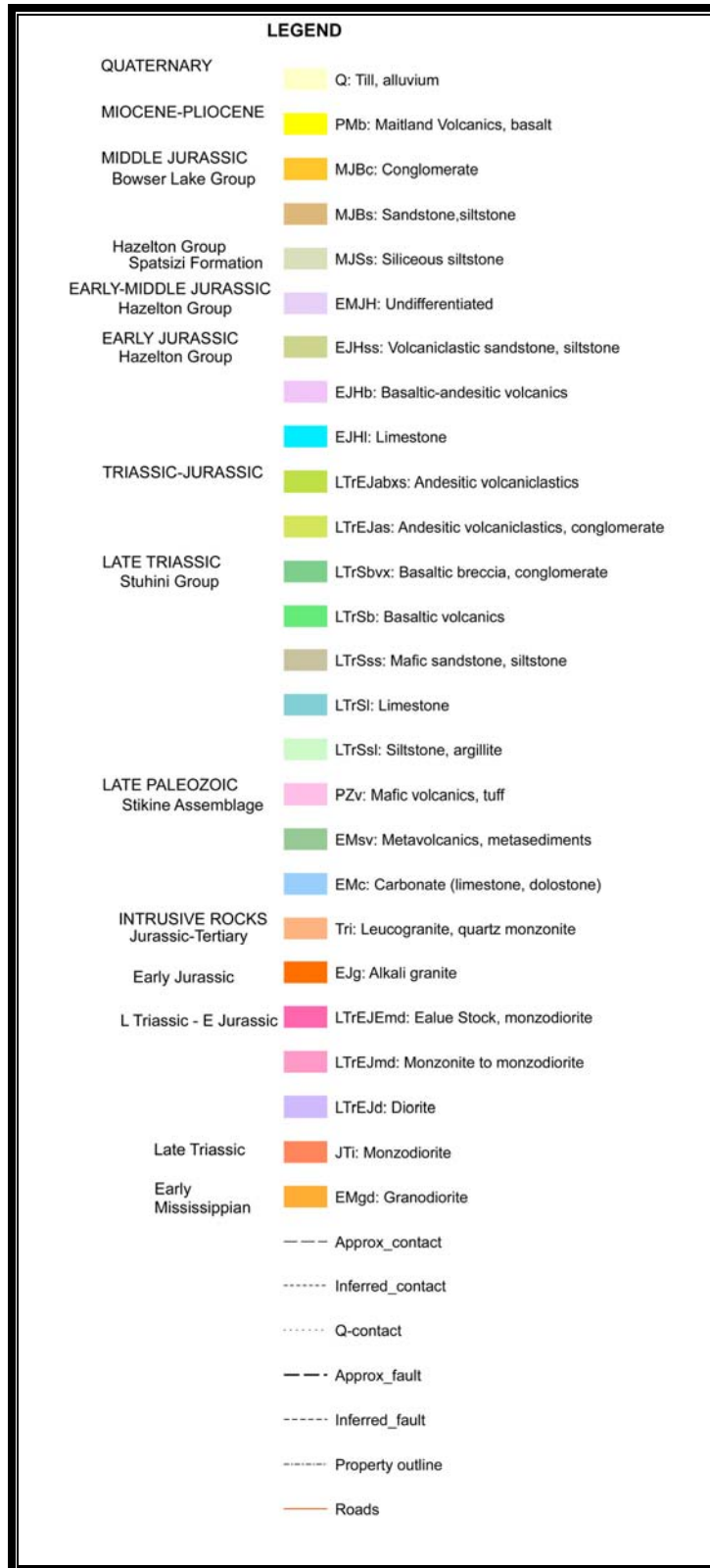

Figure 7.3 Red Chris Property Geology Map Legend



7.4 Local Geology

7.4.1 Red Stock setting

The Late Triassic Red Stock (see figure 7.4a), which hosts the Red-Chris deposit, is an ENE-elongate intrusion, about 5 kilometres long by up to 1.5 km wide at surface. The intrusion tapers to narrow dikes in the northeast and in the far west. The stock's northern contact is steep, around 80° on average, dipping either north or south, and may be faulted, in part (see figure 7.4b).

On its southeastern side, the stock is bounded by a NE-trending, south-side-down fault which abruptly places the stock and its Stuhini Group country rocks against the Bowser Lake Group at the present level of erosion. The fault is known as the South Boundary Fault (SBF), and is assumed to be mainly normal slip and to dip steeply SE. It may actually be a series of parallel faults. It is Late Jurassic or more likely Cretaceous in age. The vertical separation on the fault(s) is not known, nor the depth of the sub-Bowser unconformity on the hangingwall side, as the basal contact has never been intersected by drilling.

Basaltic volcanics and volcanoclastics are the predominant Stuhini Group host rocks along the northern margin of the stock. Carbonate-pyrite alteration occurs in the volcanics, generally increasing towards the stock, especially within about 150 metres of the contact. Drilling through the volcanics towards the intrusion reveals biotite-rich hornfelsing due to contact metamorphism. In the west and east, however, the Red Stock is in contact with Stuhini Group mafic-feldspathic sandstone and lesser siltstone, with only minor volcanics forming the host rocks.

In the down-faulted block south of the SBF, the rocks comprise grey and pink-grey, thinly bedded and laminated siliceous siltstones of the Quock Member of the Middle Jurassic Spatsizi Formation of the Hazelton Group, paraconformably overlain by Middle Jurassic Bowser Lake Group. The latter comprises grey-brown, thinly bedded shaly siltstone with minor cm-scale claystone beds and minor shell-rich siltstone, chert-grain rich sandstone, and lenses of resistive chert-pebble conglomerate. Formerly known as the Ashman Formation, the rocks are now termed Todagin Assemblage (Evenchick and Thorkelson, 2005), and interpreted as marine slope facies, with local channels or submarine fans filled with pebble conglomerate.

At least one small outlier of olivine-phyric basalt is present in the far south of the property, conspicuous by its well-developed columnar jointing. The rocks are assigned to the early Pliocene Maitland Volcanics unit of Evenchick and Thorkelson (2005). They are compositionally similar to the Mount Edziza volcanics, and are within the age range (5.7-4.9 Ma, K-Ar) of that event, and are thus correlated.

Figure 7.4a Red Chris Deposit Geology Map

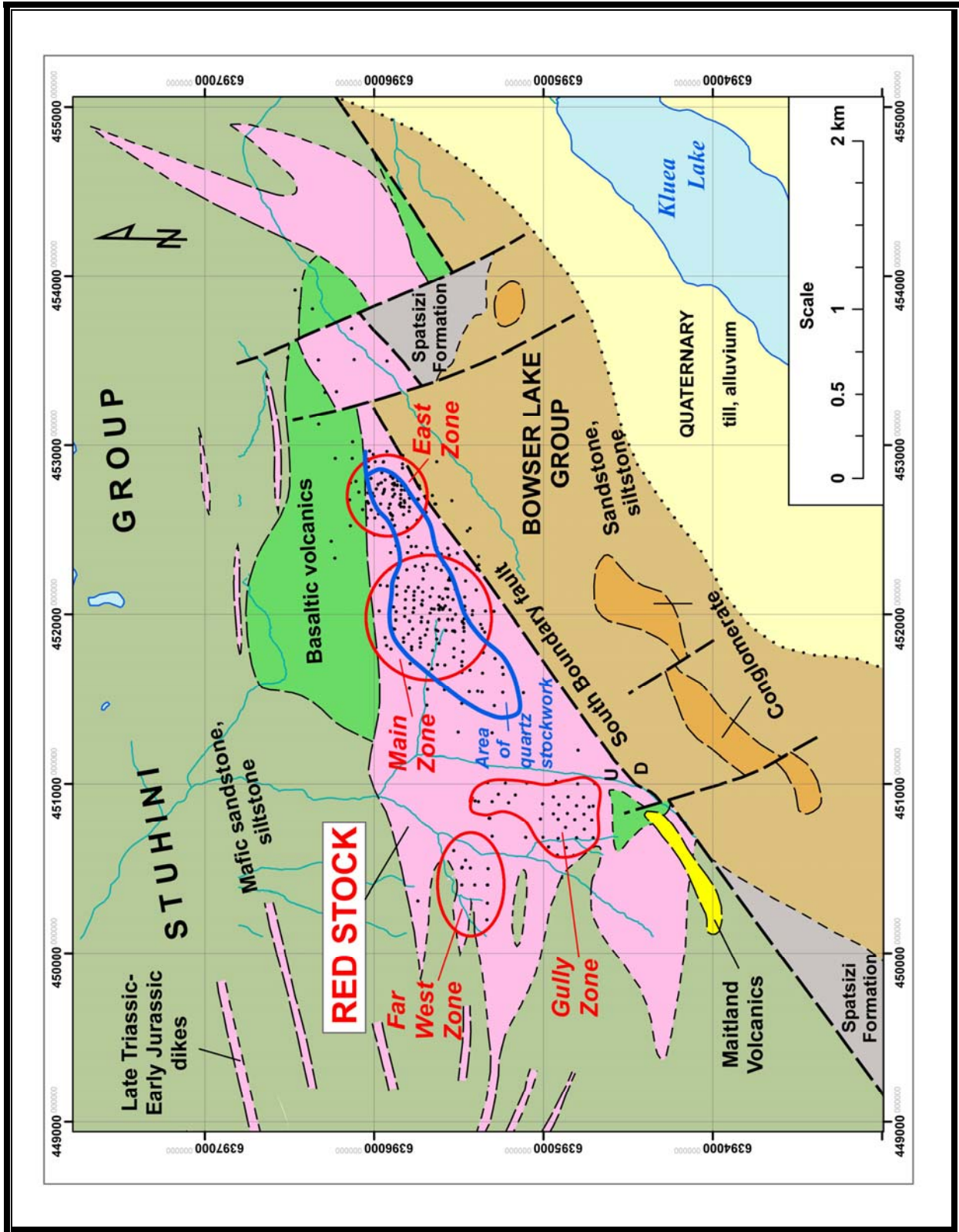
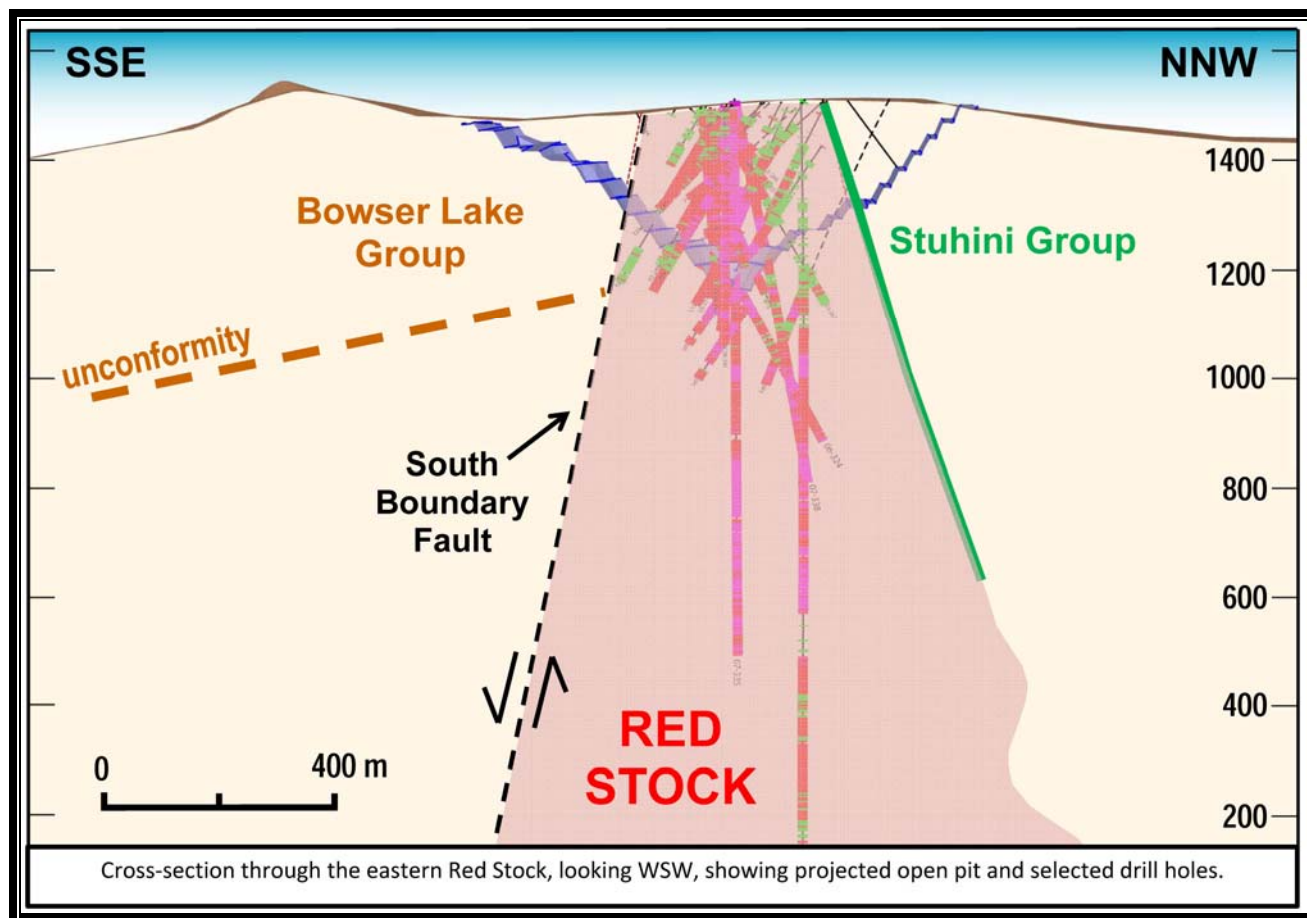

Figure 7.4b Red Chris Geological Cross Section



7.4.2 Red Stock geology

The Red Stock is texturally diverse and variably porphyritic, with multiple internal contacts, and it is better regarded as suite of dike-like intrusions instead of a single homogeneous body. The composition of the phases is dominantly monzodiorite with minor quartz monzodiorite or monzonite, and they were probably emplaced in a relatively short period from a single magmatic event. Friedman and Ash (1997) reported that four zircon fractions from drill core have been dated at 203.8 ± 1.3 Ma by U-Pb on zircon, which is taken as Late Triassic (*i.e.* assuming the boundary with the Jurassic is *ca.* 200 Ma).

Two compositionally similar phases of plutonic rocks comprise the majority of the Red Stock and these rocks are cut by several types of post-mineral dikes. The 'Main Phase' unit is a medium-grained, weakly- to intensely altered plagioclase-hornblende porphyritic monzodiorite. Colour varies from pale grey to pink-grey, depending on alteration. Plagioclase phenocrysts are typically 3 to 8 mm long, and form about 10 to 15% of the rock, although they are quite commonly sparse or absent. A trachytoid alignment from flow banding is quite common. Hornblende phenocrysts are smaller, usually 5 mm or less, and may also show alignment. The groundmass is fine to medium grained. The Main Phase hosts

most of the known copper-gold mineralization and constitutes approximately 70-80% percent of the stock.

The 'Late Phase' unit is a late- to post-mineral phase of the same monzodiorite composition, but with indistinct flow banding and chilled margins against the Main Phase. The Late Phase is remarkably similar in composition and texture to very weakly altered Main Phase rocks, and is distinguished by its 'fresher' appearance and milder overprinting by at least the high-temperature secondary minerals (see below under 'Alteration'). In addition, the Late Phase is usually barren of copper-gold mineralization. It represents approximately 20-28% of the stock.

Cutting both the Main and Late phases are post-mineral dikes which are typically porphyritic and amygdaloidal and range in composition from dioritic to monzonitic. They are usually less than 1 to 5 metres wide, although they may attain widths of up to 50 metres in the western end of the Red Chris deposit area. These dikes form most of the remaining volume of the Red Stock.

Minor breccia occurs throughout the Red Stock, especially along the northeastern and western margins. Breccia bodies may range in width from a few metres to 100 metres or more. Their contacts are relatively distinct, marked by a rapid increase or decrease of subangular to angular fragments of plutonic rock. These fragments can vary from less than a centimetre to several metres in diameter. The matrix of the breccias may be igneous or rock flour or both. The breccias are interpreted as magmatic-hydrothermal, or the result of stoping along intrusion contacts, depending on the matrix-type.

7.4.3 Structure

The apparent ENE linear trend of the Red Stock suite suggests that it was intruded along a syn-arc structure. Within the stock itself, this trend dominates the orientation of dikes, brittle and semi-brittle faulting, and also quartz veins and vein stockworks which host the mineralization at Red-Chris. Quartz vein density, and high-angle, EW- to ENE-trending faults or fracture zones are concentrated in the central axis of the stock (see figure 7.4a). Structural zones characterized by semi-ductile shearing of quartz (+/-carbonate) veins, or by healed tectonic breccia, attest to relatively early and high-temperature shearing in the intrusion, whereas friable and low-competency zones dominated by clay alteration or gouge represent deformation under later, cooler conditions. Previous workers (see Giroux *et al.*, 2002) contended that the dominant 'axial' structures are concave to the south with normal dip-slip.

Numerous, steeply dipping transverse faults deform the Red Stock, striking NNW to NNE. The geometry and separations related to these faults have been assessed by constructing level plans using drill hole data. Most geological features are allegedly traceable from N-S section to section, and to depth, implying that most of the transverse faulting does not radically affect 'along strike' continuity of ores zones.

Despite the deformation, the structural complexity of the Red Stock should not be overstated, since the mineralization is apparently not significantly dismembered, and Giroux *et al.* (2002) maintained that at least later-stage faults and dike orientations are both laterally and vertically remarkably continuous, traceable for hundreds of metres in some cases.

7.4.4 Alteration

Two overlapping signatures of hydrothermal activity have affected the Red Stock (see figure 7.4c): an earlier high-temperature, ‘potassic’ alteration stage, of K-feldspar (orthoclase)-albite-biotite-magnetite-anhydrite, superimposed by a lower temperature alteration of sericite-quartz-pyrite (ferrocarbonate-kaolinite-illite). Quartz veining and copper sulfide deposition are associated with both the early potassic and later sericitic alteration stages.

Figure 7.4c Red Chris Hydrothermal Alteration Cross Section

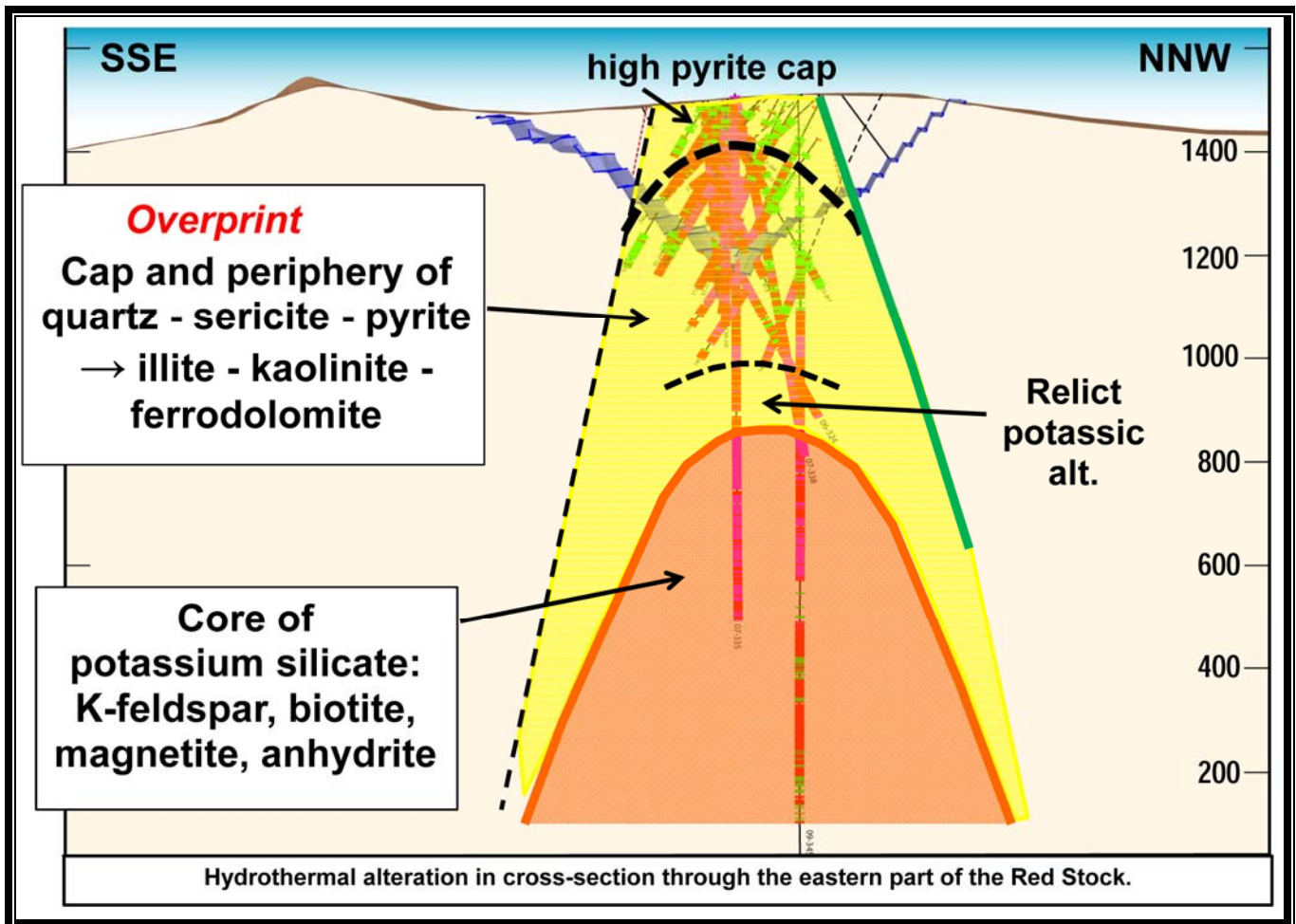

The earlier ‘potassic’ phase is preserved only at deeper levels in the stock (see figure 7.4d), where the monzodiorite is coloured reddish (dark) brown or pink from pervasive secondary K-feldspar and semi-pervasive fine biotite. This is variably overprinted by the younger, sericite-quartz-pyrite alteration, which is far more developed in at least the upper 500 metres of the stock, and is exclusive at the present level of erosion. Even at depth, the sericitic overprint is present in fracture zones or around the larger veins where ‘post-potassic’, lower temperature and acidic fluids were able to penetrate. At shallow levels of the hydrothermal system, significant kaolinite and illite commonly form part of the sericitic overprint assemblage, especially in zones of stronger deformation. Early-stage magnetite is preserved

only at depth, in the potassic assemblage; elsewhere the characteristic iron oxide is black, specular hematite and earthy red hematite.

A characteristic of the Red-Chris hydrothermal system is the presence of significant ferrocarbonate. It is mainly associated with the lower temperature sericitic overprint, especially in accompanying quartz veins. After exposure, the carbonate in drill core gradually oxidizes to an orange-brown colour, clearly distinguishing it from grey quartz and silicate minerals.

Figure 7.4d Red Chris Hydrothermal Alteration Long Section

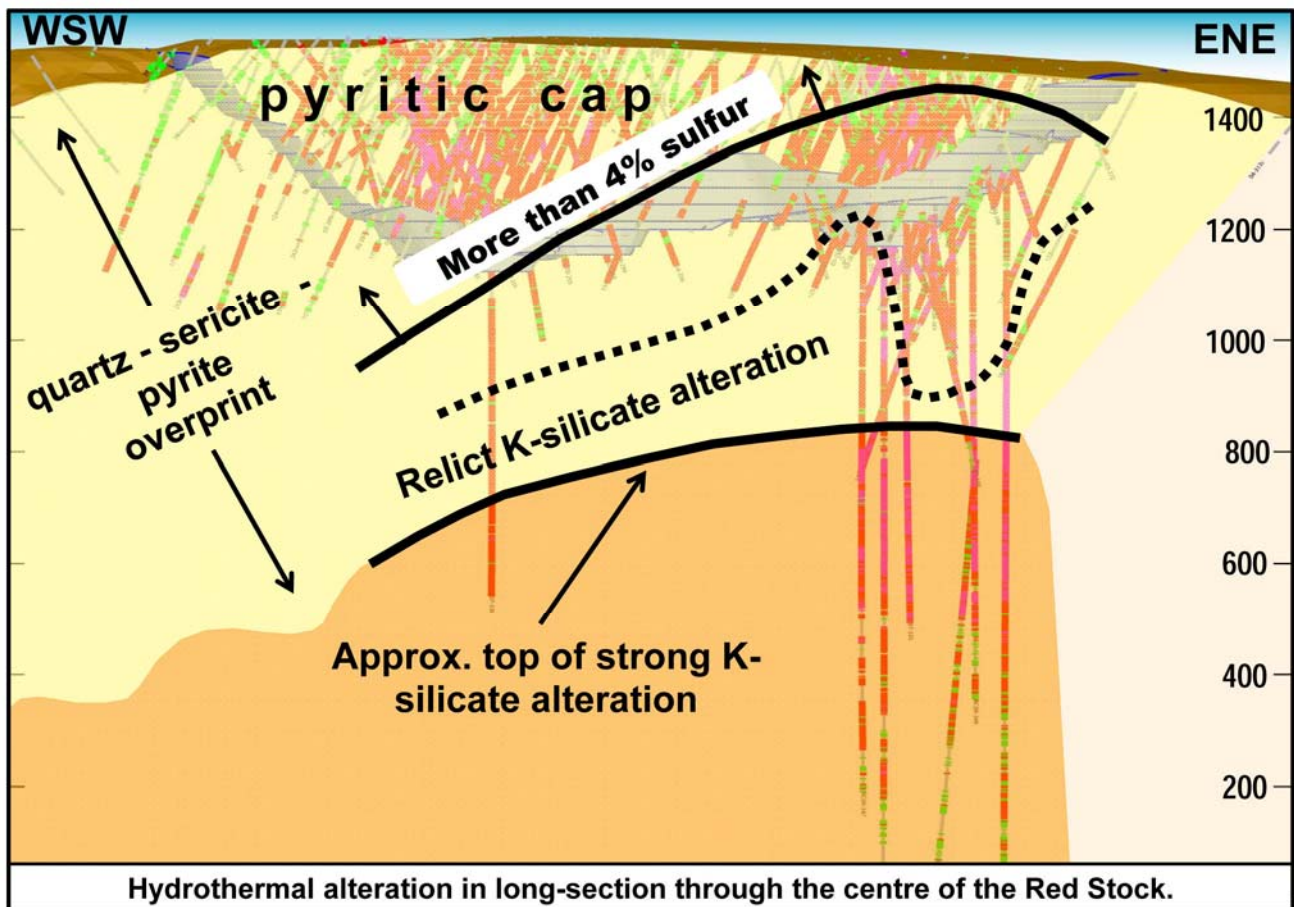

8 DEPOSIT TYPE

8.1 Classification

The Red Chris deposit displays characteristics of both alkalic and calc-alkalic porphyry systems.

Calc-alkalic characteristics of the deposits are;

- the relatively centralized mineralization
- large tonnage potential of the system
- strong association of copper sulfides with quartz veins, and
- quartz-sericite-pyrite or ‘phyllic’ alteration halo, which is generally absent in alkalic systems, especially in British Columbia.

Alkalic characteristics of the deposits are;

- monzodiorite host rock lithologies
- relatively high K_2O , Na_2O lithogeochemistry
- copper-gold metal signature
- magnetite-bearing potassic alteration
- relatively high-grade and compact dimensions (alkalic deposits tend to be smaller tonnage, with better grades locally).

The ideal way to classify porphyry systems is by the use of whole rock chemistry, but reliable whole-rock lithogeochemistry is limited to date. The available data indicate Red-Chris should be assigned to the high-K calc-alkalic category of Lang et al. (1995), which places it in between the fields occupied by more-diagnostic alkalic and calc-alkalic systems. Other high-K calc-alkalic deposits such as Grassberg, Oyu Tolgoi and Bingham share many characteristics with the Red Chris deposit.

8.2 Exploration model

Prior to Imperial Metals Corporation’s acquisition of Red-Chris in early 2007, historic drilling had established significant copper-gold mineral resources in the Red Stock, down to about 400 metres from the present-day surface. Since the objective had been open-pit feasibility, many drill holes were terminated in mineralization. Two deeper drill holes in the eastern part of the deposit had gone down to between 600 and 750 metres below surface, showing that mineralization did indeed continue substantially below the projected pit, but this did not prompt a change in strategy at the time.

While Imperial was preparing to mine the shallow deposit, further exploration was planned in the lower levels of the system to determine if the mineralization beneath the current design open pit might be economic. Deep drill holes, to 1000 metres depth in 2007 and 2008, and to 1,500 metres depth in 2009, were successful in finding significant copper-gold mineralization to at least 1,000 metres below surface. The best grades were encountered beneath the eastern part of the reserve, stimulating further infill and step-out exploration, which is ongoing. The deep drilling results indicate a general continuity of mineralization from the surface to depth, the main changes being: (1) an increase in the amount of preserved potassic alteration downwards, at the expense of the sericitization overprint, and (2) a decrease in the amount of total sulfides, although this is mainly expressed by diminishing pyrite relative

to chalcopyrite and bornite, such that copper-gold grades remain consistently moderate to high. The density of quartz veins does appear to subside at deep levels (+1000m) compared to the upper parts of the system. Copper grades decline with decreasing quartz veining, so exploration is focused on tracking zones of strong quartz veining, where some exceptionally high-grade mineralization has been found.

There has been much less deep drilling (to date) beneath the central and western parts of the reserve than in the eastern part, but the emerging exploration model is permissive of an expansion of deep mineral resources to the west, as well as towards underexplored ground immediately east and northeast of the pit reserve outline. Future drilling programs will address this potential. Drilling beneath the unconformity on the hanging wall side of the South Boundary fault is a more ambitious project is being driven by the pronounced magnetic anomaly there.

Other Late Triassic-Early Jurassic intrusions on the property are worthy of geochemical exploration, with some already showing highly anomalous values of copper and/or molybdenum. Further geological mapping and sampling is planned.

Figure 9.1 Red Chris Split Core: High Grade Chalcopyrite

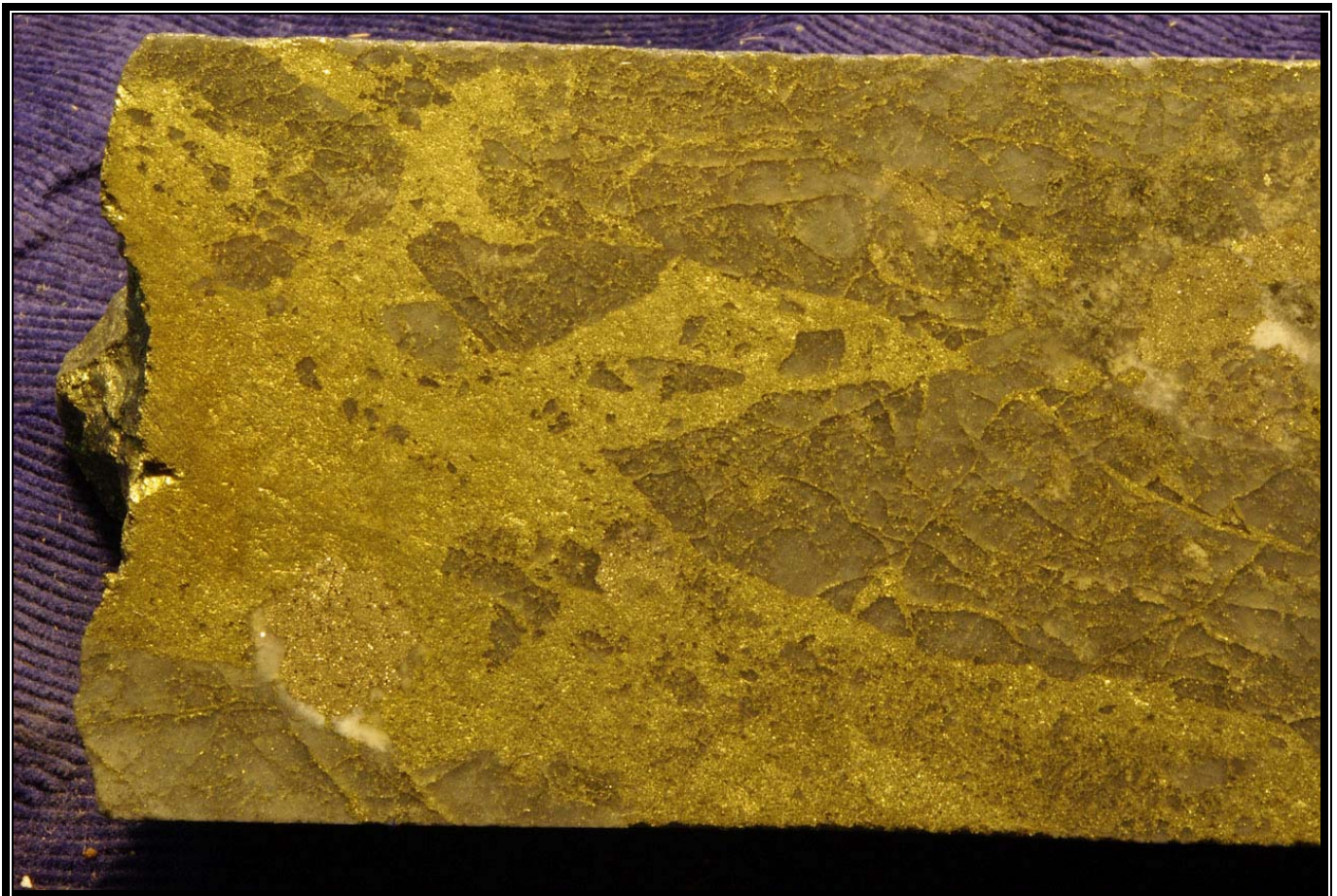

9 Mineralization

9.1 Introduction

(Some aspects of the mineralization such as the host rock geology and structure are described elsewhere in this document.)

Overall, the Red Stock is relatively homogeneous, and alteration and sulfides are widely disseminated within it. However, significant copper-gold mineralization is concentrated along a west to east or east-northeast corridor in the centre of the dike complex (see figure 7.4a), closely associated with stockworks of quartz veins introduced into zones of mild to intense, subvertical fracturing. Copper-gold grades are correlated with the density of quartz veins. This association between mineralization and structure may be related to repeated reactivation of an ancestral tectonic weakness along which the Red Stock was originally emplaced, and which continued to guide dike intrusion, shearing, and hydrothermal permeability until the system lapsed.

9.2 Mineral zones

Within this scenario, a number of zones of high-grade copper-gold mineralization have been delineated in the Red Stock (see figure 9.1). The two principal zones targeted for development are the East Zone, and the Main Zone, 800 metres to the west (see figure 7.4a). A further 1.5 km to the west of the Main Zone, at the western end of the Red Stock, are the Gully Zone and the Far West Zone. Some mineralization in the Far West Zone is hosted in Stuhini Group country rocks. The age of the Red-Chris mineralization is the same as the intrusion itself, i.e. approximately 204 Ma, or Late Triassic.

9.3 Dimensions, depth

At surface, East Zone and Main Zone mineralization extends over approximately 1,500 metres, east-northeast. In width, it ranges from at least 200 metres in the East Zone to 500 metres in the Main Zone. The depth of significant mineralization is about 1,000 metres in the East Zone and in the apparent centre of the Main Zone. Beyond the areas of deep drilling, depth of mineralization is known only to around 400 metres.

The Gully zone footprint is approximately 500 metres across, east-west. Mineralization begins at surface, and has been drilled to a depth of approximately 400 metres. The Far West zone has a smaller footprint and has seen less drilling.

9.4 Mineralization textures

Pyrite, chalcopyrite and lesser bornite are the principal sulfide minerals; minor covellite occurs as inclusions in pyrite, and molybdenite, sphalerite and galena occur very locally in trace amounts. In the ore zones, chalcopyrite is most abundant in the quartz-sulfide vein stockworks and quartz-sericite-ferrocarbonate alteration selvages (see figure 9.4). In quartz veins, chalcopyrite occurs as disseminations or mm-scale blebs or coarser aggregates, and as fracture coatings and fillings both parallel to and crosscutting the quartz veins.

Copper sulfide content is roughly proportional to the intensity of quartz veining, except in the Gully and Far West zones. Where quartz-sulfide vein stockwork intensity diminishes, copper grades may remain elevated due to the presence of fine-grained chalcopyrite (and pyrite) disseminated in the monzodiorite, and along fractures (commonly with pyrite veinlets), and rarely as pure veinlets. This is particularly the case in the Main Zone at depth (300-400 m).

Bornite is most common as microveinlets and fine-grained (0.5 mm) disseminations in the quartz-sulfide vein stockwork zones of the East Zone, both within the vein cores and as crosscutting veins. In zones of strong sheeted quartz veins in the East Zone, copper assays can reach several per cent. Bornite is also intimately associated with disseminations, fracture fillings and coatings and aggregates of dark red or blue-black specular hematite. This association makes visual estimates of grade difficult and invariably too low. Bornite also occurs as fine-grained disseminations in the highly altered Main Phase monzodiorite of the eastern Main Zone. Bornite in the Gully Zone is much less abundant than in the East and Main zones. In portions of the deep East zone, bornite is the dominant copper mineral.

Gold, second in economic importance to copper, occurs spatially- and genetically-associated with the copper mineralization. Microscopic gold grains are intimately associated with the copper sulfides. Silver values are geochemically low but still of economic importance.

Pyrite occurs commonly as very fine- to fine-grained, anhedral to euhedral disseminations, fracture fillings, and veins. Within the mineralized zones it is commonly poikilitic with numerous copper sulfide and iron oxide inclusions; outside the zones, the inclusions are commonly sericite and dolomite. Pyrite content is variable throughout the deposit, ranging from less than 1% to 10%. It's distribution is highest above the >4% sulfur line shown on figure 7.4d and diminishes significantly below that. It is most abundant peripheral to the higher grade copper mineralization, where it is not truncated by faulting. Pyrite is abnormally low or absent in many areas of the high-grade East Zone except near the surface, but it is quite ubiquitous throughout the Main Zone ore. Later stage pyrite (\pm chalcopyrite) veins cut quartz vein stockworks, and are typically associated with narrow hematite veinlets. The partial replacement by pyrite or other sulfides of hornblende phenocrysts and, to a lesser degree, plagioclase phenocrysts is common. Significant pyrite occurs in the Stuhini Group volcanics up to 100 to 150 metres from the intrusive contact, especially where it is accompanied by rusty-weathering bleaching from the complete destruction of ferromagnesian minerals by carbonate alteration, probably related to hydrothermal fluid circulation around the stock.

Secondary magnetite and hematite are most commonly associated with mineralized quartz stockwork zones and plagioclase-hornblende-biotite dikes where they may represent up to 10 modal per cent. They usually occur as fine-grained disseminations in the veins and host rocks but they also occur as magnetite-hematite veinlets and quartz-magnetite veinlets. Magnetite is more prevalent at deeper levels; higher in the system it is typically replaced by specularite and ultimately earthy red hematite.

Prominent limonitic gossans occur within the steep slopes and drainages over the Gully and Far West zones. However, in areas of low relief such as over the East and Main zones, weak limonite only extends 1 or 2 metres beneath the top of the bedrock. The overlying gravel till layer is often very limonitic or composed of ferricrete. Thus, it appears that glaciation has removed any of the supergene mineralization that might have existed over the Red Chris deposit. However, supergene chalcocite mineralization has reportedly been

intersected in shallow drilling near the headwaters of the East Gully drainage. Chalcocite occurs along with malachite, azurite and manganese oxides in this oxidized zone.

Figure 9.4 Red Chris Core Sample: Chalcopyrite in Quartz Stockwork



10 Exploration

Since acquiring the Red Chris Property in 2007 Imperial Metals has conducted an aggressive exploration and drilling program. The program has consisted of diamond drilling, geological mapping, and geophysics. From 2007 to 2009 Imperial has drilled 20 holes targeting deep mineralization mostly in the East Zone (see chapter 11 for details).

10.1 Geophysical Programs

10.1.1 Titan 24 Geophysical Survey

A Titan-24 geophysical survey was conducted in 2009 as an exploration tool to delineate potential porphyry style mineralization at depth within and surrounding the Red Chris deposit. The survey consisted of 13 parallel lines with 400m line separation with station spacing of 100m. DC, IP, and MT measurements were completed along each line. The survey line length was approximately 2.4km plus additional current injections up to 500m beyond the ends of the survey line for the DC/IP measurements. The DC/IP measurements were completed along a total of 30km (40.2km with current extension). The MT surveys were carried out along a total length of 30km. Finalized results and interpretations of the survey are pending.

10.1.2 Airborne Magnetic Survey

A 1,295km Aeroquest airborne magnetic survey was flown over the Red Chris deposit between October 13th to October 15th, 2009. The survey was conducted with a helicopter stinger-mounted cesium vapour magnetometer. Ancillary equipment included a GPS navigation system, radar altimeter, digital video recording system and a base station magnetometer.

10.1.3 Proton Magnetometer Survey

A Proton Magnetometer program was established in 2009 with the use of a GSM 19T Series Magnetometer V7 unit. The program commenced August 15th and concluded September 31st. The extensive program included traverses over the entire Titan geophysical grid, road and trail networks as well as concentrated traverses in areas of interest. The purpose of the program was to identify covered geological contacts and faults, as well as add to the growing geophysical database for vectoring purposes within the Red Chris deposit.

10.2 Composite Sampling Program

Eighteen drillholes from all the deposit zones were selected for multi-element analysis to assist in targeting deeper mineralization in peripheral areas. Core from the selected drill holes was quartered and bagged individually according to original sample tag number (eg 94851). Samples were then composited into groups of four to six sequential samples (eg 94851-94855). In the case that a tag number within a composite sample represented a standard, duplicate or blank, that tag was eliminated from the composite sample. The four to six samples that yielded one composite were placed together in a rice sack, and shipped to Acme Analytical Laboratories in Smithers. A total of 2500 quarter cut samples comprising 486 composite samples were cut and shipped.

The samples were crushed in Smithers using a Terminator Jaw Crusher to 80% passing 10 mesh sieves. The samples were then shipped to Vancouver and pulverized using a ring and puck to 85% passing 200 mesh sieves. The representative portion of the pulverized material was then weighed and separated to be homogenized with the remaining samples. The composite sample was then sent analyzed using a 4-acid, 1EX ICP-MS package. The remainders of the pulps were sent via commercial vehicle transport to Imperial Metal's storage facility at Mt. Polley Mine.

10.3 Camp and Infrastructure Improvements

The 2007 to 2009 exploration program utilized the long since established Red Chris camp, with additional resources and improvements made to accommodate increasingly larger programs and winter operations. The established 25 man camp is complete with a kitchen, dining area, dry, showers, flush toilets, washer/dryer, office, maintenance sheds, and individual 4-man tent cabins. There is also a dedicated first aid shack, compliant with Health and Safety requirements. Water to the camp is derived from a 100m well located 100m east of the camp (see figure 10.3).

Due to an increase in the program scope and year round exploration requirements, four trailer sleeper units were installed in late 2008. The four new units (equipped with 7 individual flush toilets and 6 showers) provide an additional 32 man capacity in camp. The trailers are arranged in rows of two lengthwise, with the space in between the sets of trailers enclosed from the elements adding additional dry/storage facilities. Additional camp improvements included insulating the tent cabins (office and sleeping units) and core shack with thermal batt insulation. Further to that core shack was upgraded with the addition of a core cutting (two rock saws) and sample preparation rooms. Additional diesel drip heaters were installed throughout the camp in preparation for winter operations.

Improvements to drill operations included the installation of a 750m waterline from Border Creek southward, surfacing along the periphery of the East Zone. A 3ft by 10ft perforated culvert was installed vertically along the periphery of Border Creek, and enclosed by a monitoring/pumping station. The waterline was buried in a 7-8ft deep trench to ensure its utility during the winter months.

Figure 10.3 Red Chris Camp



10.4 Property Access Trail

The 17km gravel access trail, which branches off at the 6km marker of the Ealue Lake road, was completed in early 2009. Further upgrades to the trail included the installation of two eco barriers, to prevent potential slope failure, and multiple culverts, to prevent washouts. Preventative reclamation was also undertaken at both ends of the Coyote Creek bridge crossing in order to eliminate potential acid rock drainage generated from pyritic rock fill (see figure 10.4).

Figure 10.4 New Red Chris 17km Gravel Access Trail



11 Drilling

Upon acquisition of the Red Chris project, Imperial conducted a helicopter-based diamond drilling program in the summer of 2007 to test for higher-grade material below the bottom of the planned pit proposed in the 2005 feasibility study. Initial results were rewarding prompting the company to construct an access into the project area prior to resumption of the deep drilling. The campaign of deep exploration resumed in the fall of 2008 and then from July through December of 2009. Figure 11.4a shows a comparison of the drilling at the end of 2006 with the drilling to the end of 2009.

11.1 Deep Drilling - 2007

Historical results from drillholes 140 and 06-324 indicated the presence of grades in excess of 1% CuEQ up to 400m below the bottom of the pit design (see figure 11.4a) . Imperial completed six holes in 2007 for a total length of 4835 metres. The most significant drillhole was 07-335, collared vertically in the core of the East zone, 07-335 graded 1.01% copper, 1.26 g/t gold and 3.92 ppm silver over its entire length in bedrock of 1024.1 metres, extending high-grade mineralization in the East Zone down another 270m from its previously-known extent. Drillhole 07-336, collared in the middle of the Main Zone, returned a vertical intercept of 996.4 metres grading 0.40% copper, 0.38 g/t gold, and 1.34 ppm silver. Drillhole 07-338, collared in the East Zone, was drilled from the same collar location as 07-335, but was angled to the north at a -78° dip. The final 46.5m of this drillhole graded 1.05% copper, 1.67g/t gold, and 1.41ppm silver, before being abandoned at 721.5 metres due to stuck rods. The final drillhole of 2007, 07-340, was collared in the East Zone and drilled at 095° azimuth. 07-340 returned 753.9m grading 0.60% copper, 0.56 g/t gold and 2.07ppm silver before terminating in a fault at 760.0 metres depth. The diamond drill program was supplemented by a deposit wide proton magnetometer survey.

Table 11.1 2007 Drillhole Coordinates

Drill Hole	Zone	Easting	Northing	Azimuth	Dip	Total Length (m)
07-335	East	6395888	452699	0	-90	1029.0
07-336	Main	6395615	452026	0	-90	1000.7
07-337	Main	6395615	452026	0	-75	1050.7
07-338	East	6395888	452699	0	-78	721.5
07-339	East	6395904	452602	95	-66	217.1
07-340	East	6395904	452602	95	-66	815.9

11.2 East Zone Deep Exploration Drilling – 2008

In 2008 three vertical holes, totaling 2,220 metres, were drilled in the East zone, targeting the deep mineralization that was discovered in the 2007 program holes 07-335 and 07-338. The first two holes of 2008 were abandoned above their target depth due to adverse ground conditions and technical difficulties with drilling. The third hole, RC08-343, collared 165m northwest of 07-335 was completed to 1273 metres, and encountered 433 metres of mineralization between 840.3 metres and 1273.2 metres, grading 0.36% copper, 0.46 g/t gold and 1.13 ppm silver. Within this intersection was a higher grade interval of 97.5m grading 0.63% copper, 0.96 g/t gold and 1.89 ppm silver (see figure 11.4a). The drill program was supplemented by geological mapping survey to further refine geological contacts (8 rock samples). To reduce helicopter reliance a 17 km access trail was constructed to camp, branching off at the 6 kilometre marker on the Ealue Lake Road. Collar locations and orientations are summarized in Table 11.2.

Table 11.2 – 2008 Drillhole Coordinates

Drill Hole	Zone	Easting	Northing	Azimuth	Dip	Total Length (m)
RC08-341	East	452775	6395881	0	-90	435.0
RC08-342	East	452803	6395890	0	-90	511.8
RC08-343	East	452572	6395995	0	-90	1273.2

Figure 11.2 Red Chris Drilling in Progress



11.3 Footprints Regional Drilling Program

In the summer of 2009 Imperial sponsored and participated in the University of BC's (MDRU) and Oregon State University's Porphyry Footprint Project. The purpose of the project was to analyze and identify the regional geochemical signatures of large porphyry deposits. Aside from the geochemical investigation, the high density of drillholes also served to update and refine the local geology, which is masked by overburden. The project consisted of 138 diamond drill holes totaling 2,440metres. The program was accomplished with the aid of a low impact Bobcat mounted Hydra Core drill (BQTK rods) and a track mounted Marooka support water truck (see figure 11.3). The Footprints project is an ongoing project; preliminary results have not yet been released.

Figure 11.3 Bobcat Mounted Hydra Core Drill



11.4 2009 East Zone Exploration Drilling

The 2009 exploration diamond drilling consisted of 11 diamond drillholes totaling 16,852.54 metres in length. Between July 1 and December 15, 2009, a total of 14,172m of HQ/NQ core was drilled with the use of a Boyles 56 and an LF-230 (see figure 11.4 for locations). The East Zone drilling program was a continued initiative from the 2007/2008 exploration programs, which discovered the extension of high grade Cu-Au mineralization past the previously established pit outline, down to over a kilometer in depth (RC07-335 graded 1.01% copper, 1.26 g/t gold and 3.92 g/t silver over 1024.1m, ending in high grade mineralization). Collar locations and orientations are summarized in Table 11.4a.

Table 11.4a – East Zone Drillhole Coordinates

Drill Hole	Zone	Easting	Northing	Azimuth	Dip	Total Length (m)
RC09-344	East	452765	6395864	0	-90	331.3
RC09-345	East	452702	6396000	0	-90	1501.1
RC09-346	East	452684	6396157	155	-77	1503.9
RC09-347	East	452675	6395822	0	-90	1315.5
RC09-348	East	452633	6395912	0	-90	1501.8
RC09-349	East	452769	6395976	0	-90	1150.6
RC09-350	East	452803	6396019	0	-90	1477.4
RC09-351	East	452518	6395803	0	-90	1501.1
RC09-352	East	452587	6395891	0	-90	1245.0
RC09-353	East	452838	6396063	0	-90	1287.8
RC09-354	East	452683	6395868	39	-71	1357.34

The 2009 drilling program successfully expanded the previously known mineralization in the Deep East Zone. All drill holes encountered significant intercepts of copper and gold mineralization, and added to the volume of the deep resource. The highlight of the program was Hole RC09-350 which was collared approximately 170 metres northeast of drill hole 07-335 and returned 432.5 metres grading 2.00% copper and 3.80 g/t gold which included a 152.5m interval grading 4.12% copper and 8.83 g/t gold starting at a depth of 540.0

The full lateral constraints on the mineralization in the East Zone have not been fully established. Detailed geological modeling of ICP data, quartz-vein densities, gold-sulphide ratios, and magnetic susceptibility have also been updated, and the evolving model suggests the presence of additional mineralization. Other significant intercepts from the East Zone drill program are outlined in Table 11.4b.

Two holes from the 2010 program (RC10-355, RC10-360) were completed and released prior to completion of this report and have been added to database used to complete the new block model and resource estimate. The significant intercepts are also listed in Table 11.4b

Figure 11.4a 3D Comparative Long Sections: 2006 Drilling vs 2009 Drilling

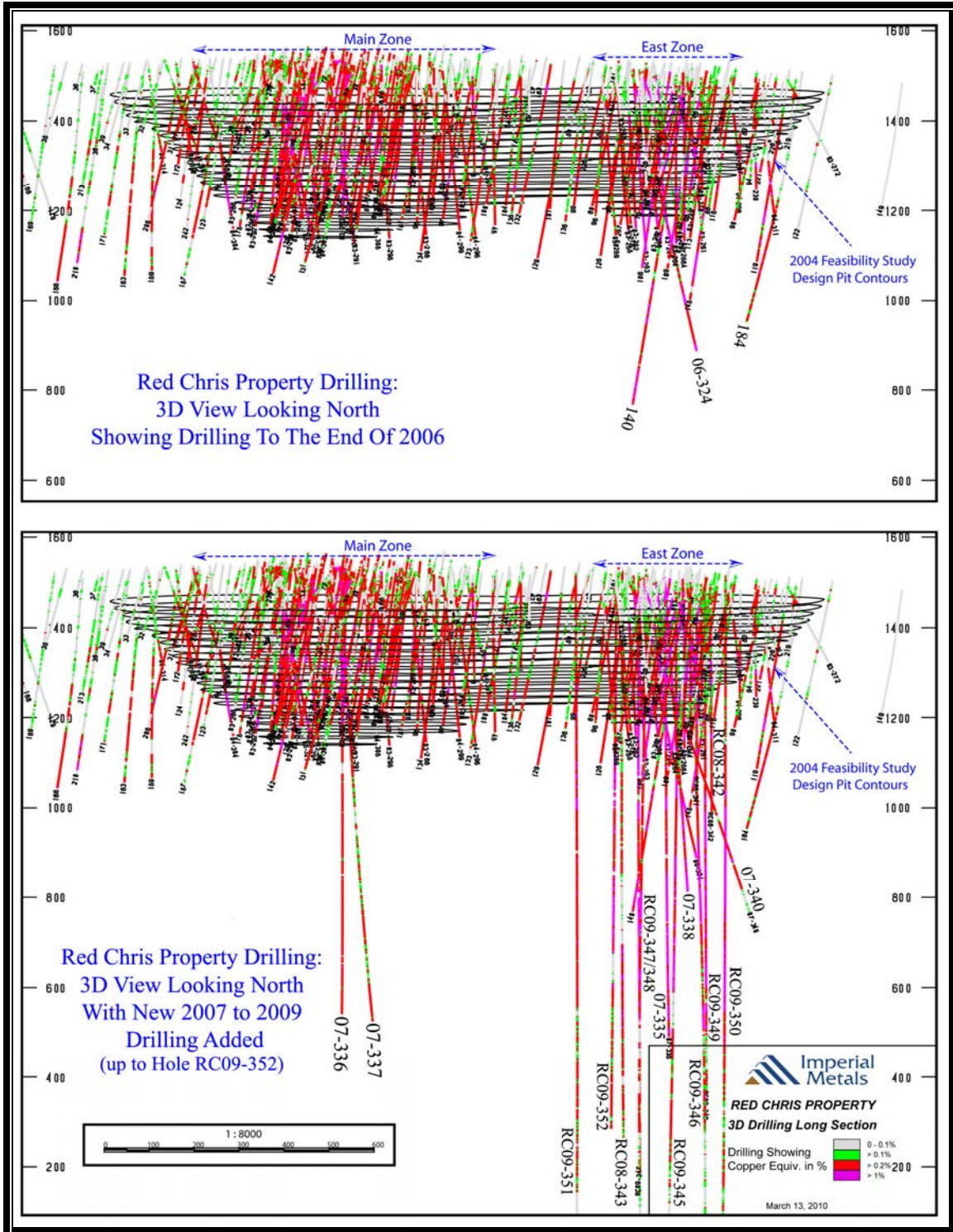

Figure 11.4b Red Chris 2009 Drilling Cross Section: Showing Assay Highlights

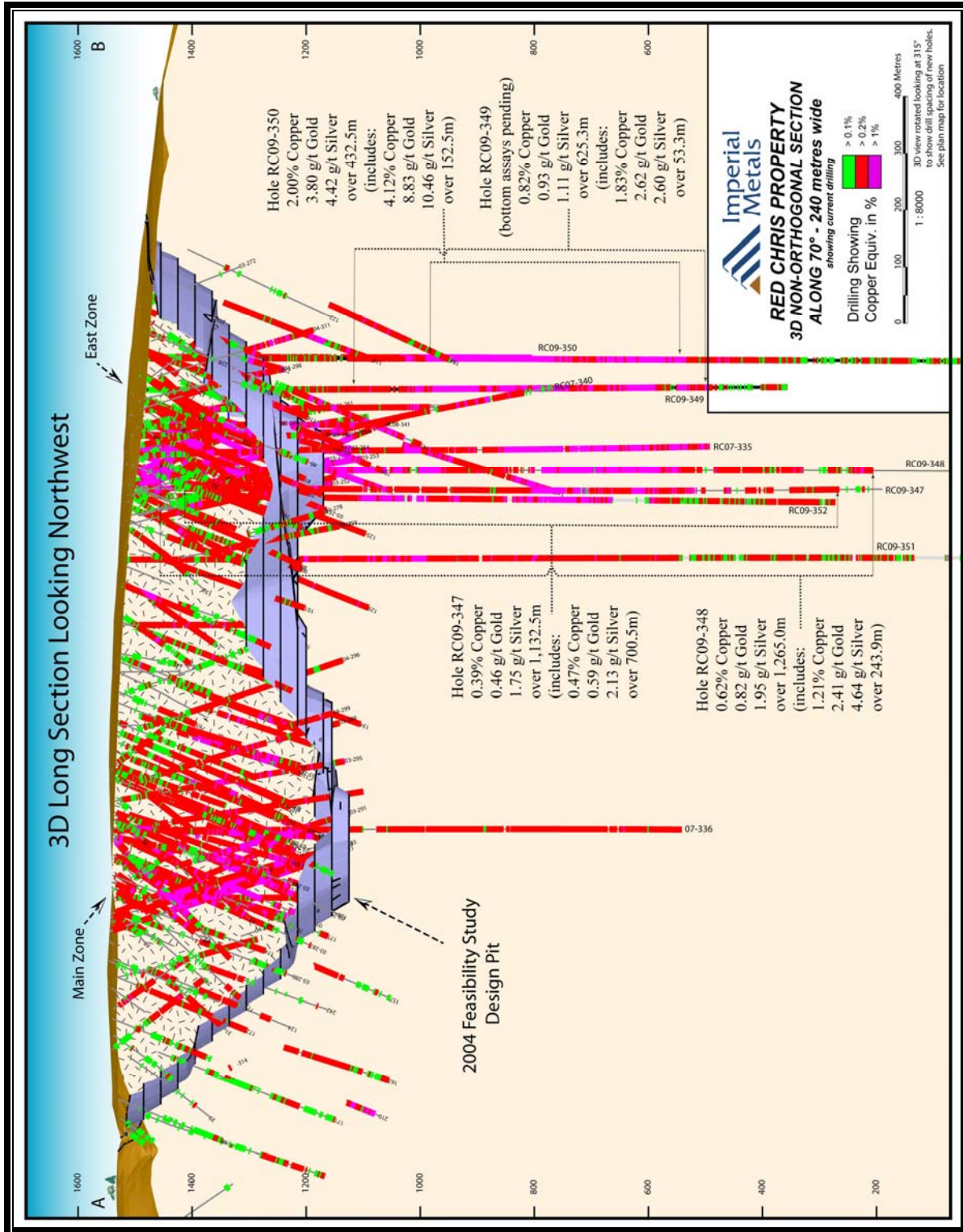

Table 11.4b – 2009 East Zone Drill Intercepts

Drill Hole	Total	Metre Interval		Interval	Copper	Gold	Silver
	Length (m)	from	to	Length	%	g/t	g/t
RC09-344	331.3	3.7	331.3	327.7	0.37	0.40	1.22
<i>incl.</i>		125.0	331.3	206.3	0.49	0.50	1.71
<i>incl.</i>		132.5	211.7	79.2	0.77	0.77	2.64
RC09-345	1501.1	426.1	952.5	526.4	0.77	1.37	1.68
<i>incl.</i>		475.0	518.9	43.9	2.22	3.22	3.35
<i>incl.</i>		833.8	950	116.2	1.06	3.11	4.09
<i>and</i>		1035.0	1090	55.0	0.40	0.41	1.02
RC09-346	1503.9	530.0	1043.6	513.6	0.61	0.91	1.16
<i>incl.</i>		615.0	806.1	191.1	0.92	1.53	1.20
<i>incl.</i>		995.0	1043.6	48.6	1.01	1.8	3.61
		1107.5	1277.5	170.0	0.21	0.16	0.97
RC09-347	1315.5	108.0	1240.5	1132.5	0.39	0.46	1.75
<i>incl.</i>		875.0	990.5	115.5	0.63	0.88	2.50
RC09-348	1501.8	42.5.0	1307.5	1265	0.62	0.82	1.95
<i>incl.</i>		725.4	969.3	243.9	1.21	2.41	4.64
RC09-349	1150.6	390.0	1015.3	625.3	0.82	0.93	1.11
<i>incl.</i>		545.0	582.5	37.5	1.51	1.89	1.54
<i>incl.</i>		866.6	919.9	53.30	1.83	2.62	2.60
RC09-350	1477.4	420.0	1067.5	647.5	1.50	2.68	3.22
<i>incl.</i>		530.0	962.5	432.5	2.00	3.8	4.42
<i>incl.</i>		540.0	692.5	152.5	4.12	8.83	10.46

Table 11.4b continued – 2009 East Zone Drill Intercepts

Drill Hole	Total	Metre Interval		Interval	Copper	Gold	Silver
	Length (m)	from	to	Length	%	g/t	g/t
RC09-351	1501.1	237.5	732.5	495.0	0.46	0.59	1.21
<i>incl.</i>		287.5	545.0	257.5	0.54	0.69	1.38
<i>incl.</i>		425.7	530.0	104.3	0.66	0.96	1.62
<i>and</i>		1092.5	1222.5	130.0	0.30	0.26	0.91
RC09-352	1245.0	115	852.9	737.9	0.54	0.6	1.61
<i>incl.</i>		300	852.9	552.9	0.62	0.73	1.85
<i>incl.</i>		407.5	530.0	122.5	0.82	0.67	1.94
<i>incl.</i>		680	850.0	170.0	0.84	1.41	3.33
RC09-353	1287.8	67.5	1202.5	1135.0	0.50	0.59	0.71
<i>including</i>		570	1020.0	450.0	0.80	1.07	1.03
<i>including</i>		632.5	705.0	72.5	1.16	1.88	1.32
<i>including</i>		912.3	952.5	40.2	0.96	1.14	1.19
RC09-354	1357.6	6.7	304.1	297.4	1.77	1.69	5.23
<i>including</i>		6.7	120.0	113.3	2.44	1.87	7.38
<i>and</i>		480	1297.5	817.5	0.55	0.47	0.82
RC10-355	1489.0	335.4	1092.5	757.1	0.38	0.48	1.27
<i>including</i>		1007.5	1065.0	57.5	0.93	1.56	4.19
RC10-360	1267.5	473.8	1002.5	528.7	1.13	1.97	1.99
<i>including</i>		607.5	962.5	355.0	1.41	2.59	2.4
<i>including</i>		700	755.8	55.8	2.00	4.22	3.25
<i>including</i>		802.5	952.5	150.0	1.83	3.34	3.35

Note: Two holes from the 2010 program (RC10-355,- 360) were completed and released before this report was completed. They were added to database and used to complete the new block model and resource estimate. The significant intercepts are listed above in Table 11.4b

Figure 11.4c 2007 to 2009 Drillhole Collar Location Plan Map

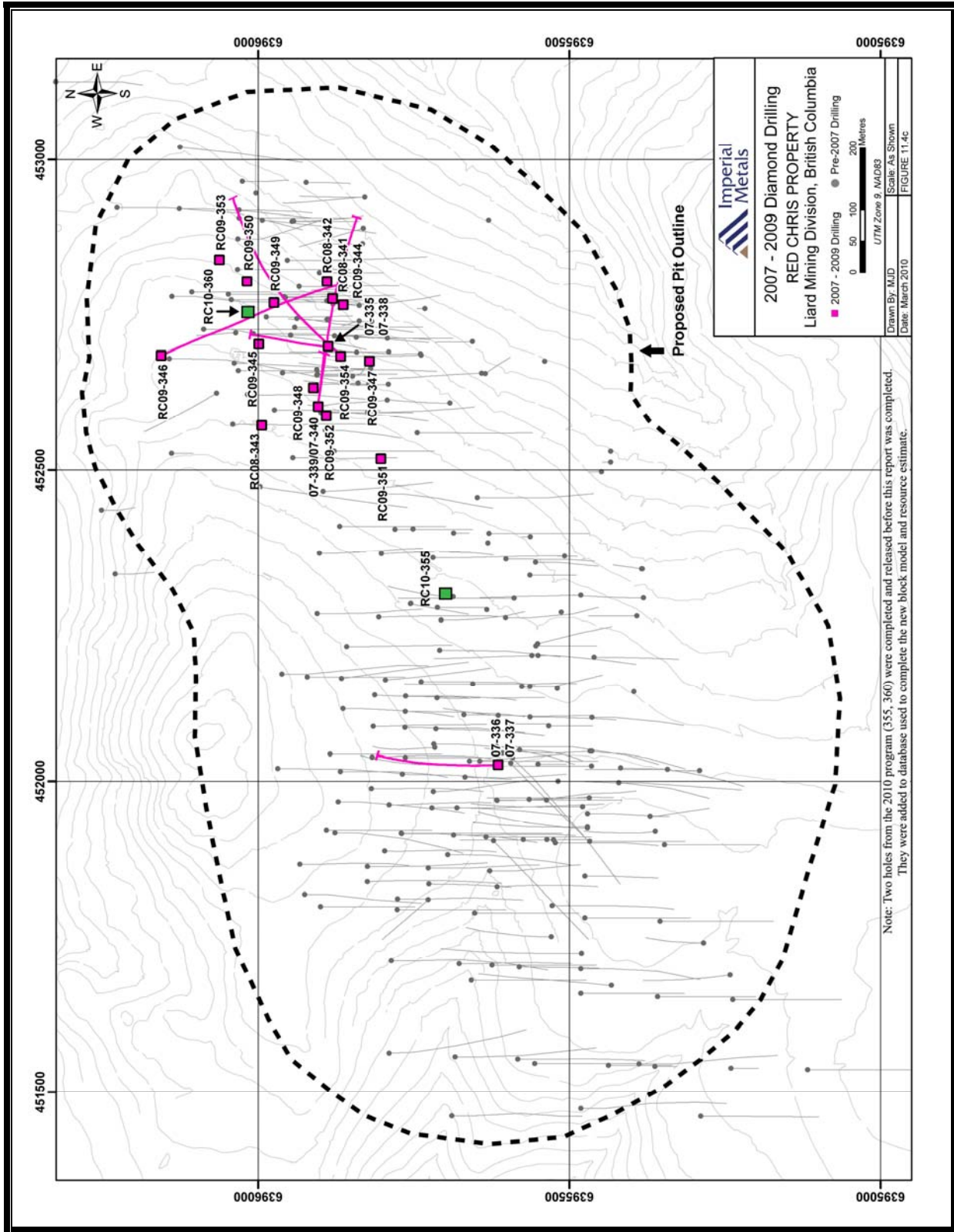

11.5 Geotechnical Drilling

Knight Peisold Ltd. was contracted to design and implement a geotechnical program to further evaluate proposed locations for mine infrastructure and facilities. The geotechnical program was conducted in September 2009, and consisted of 4 holes in the newly proposed plant site area, 2 holes in potential crusher site areas, and 2 holes in the valley bottom of the tailings storage facility site. A total of 239.7m was drilled with the use of a low impact Bobcat Mounted Hydra Core drill (HQ rods) and a track mounted Marooka support water truck. Additional information was collected from 3 embankment cuts along the newly developed tailings access, data from previously installed groundwater monitoring wells and piezometers, and from site material mapping. This program is ongoing.

Figure 12.1 Red Chris Core Storage Area



12 Sampling methods and Approach

12.1 Drilling Core Handling Procedures

Drill core handling begins at the drill where the core tube is retrieved from the downhole origin of the drilling, by way of an overshot and wireline. The wireline is used to hoist the core tube to surface where the drill crew extracts the drill core from the core tube. The drill core is placed into 1.3 metre long core boxes, laid out so that it is in the same order that it was retrieved in. The core placement reflects English reading with the most shallow core in the top lefthand corner of the core box and the deepest core located in the bottom right hand corner of the core box. Permanent marker is used to label box with information on the hole number, footage and box number. Wooden blocks labeled with the appropriate metreage are placed between each drill run. Once full, the core box is secured for transport to the logging facility.

The Red Chris site has a dedicated facility for handling and logging drill core, known as ‘the Core Shack’ (see figure 12.1 above and 12.2 below). Once drill core is received into the Core Shack, the core is washed and logged (geotechnically and geologically). Then the core is separated into 2.5m sample intervals by a geologist. The 2.5m sample length can be split in two, if needed to conform to a geological contact. Geotechnical data collected included core recovery, RQD, fracture counts, core strength, and overall ratings, with special attention paid to the occurrence of slickensides and fault gouge.

Each core box is permanently labeled with aluminum tags which show information reflecting hole name, box number and metreage at the top and bottom of the core stored in the box. Sample tags are stapled into the box at the beginning of each sample interval.

The core is logged with a KT-9 magnetic susceptibility meter over every sample interval. Ten susceptibility readings are taken for each sample, and then averaged. Geology data is recorded into Lager (Northface Software), a database program designed for exploration drilling. Sample tags are placed at each sample contact by a geologist. Standards, duplicates, and blanks are randomly inserted within every 17 consecutive core samples.

The marked and tagged core is then photographed. Three additional whole rock samples are collected every 100m for geotechnical analysis. The first sample consists of a 10cm drill hole core plug which is sent to ACME for specific gravity analysis. The remaining two core samples are selected to test the axial (4cm NQ and 6cm HQ) and diametral (5cm NQ and 10cm HQ) strength of the rock. This is conducted onsite with a point load testing device.

Samples are returned to the core boxes after tested. The core is subsequently cut longitudinally using diamond bladed rock saws. Cut core is placed into clear poly-ore bags with the sample tag and zap-strapped. The other half-core is left in the core box, with the sample tag stub stapled to the start of the appropriate sample interval. Archived core is stored on-site in wooden racks. Sample bags are placed into white plastic rice bags, labeled, and zap-strapped with red numbered ties. The rice bags of samples are driven to Iskut and stored on pallets at the locked Bandstra Depot. Twice a week samples are shipped via Bandstra to ACME’s preparation Lab in Smithers.

12.2 Down Hole Survey and Collar Coordinates

Downhole surveys were periodically conducted on the drillholes to measure their deviation. This is facilitated during bit changes and hole shutdowns by using a Reflex EZ-Trac downhole probe. Measurements were taken every 9.14m (three rods), with the probe suspended by aluminum running gear 7m beyond the drill-bit. The EZ-Trac is manufactured such that a handheld computer is synchronized to the probe, and measurements can quickly be obtained during the pulling of rods. Magnetic interference of the EZ-Trac is negligible at Red Chris due to the low amount of magnetite. Data recorded at each survey station included azimuth, dip, temperature, and magnetic field strength. Drillhole collars were surveyed with a handheld Garmin 60csx GPS, with accuracy to 3m.

Figure 12.2 The Red Chris Core Shack



13 Sampling Preparation, Analyses and Security

13.1 Sampling Method, Approach and Security – 2007 to 2009

Drill core from the 2007, 2008 and 2009 drilling programs was processed, logged and sampled on site by Imperial Metals employees. Delivery of the core from the drill to the logging and sampling facility was via helicopter (2007 program) or truck (2008 and 2009 programs). Once the core was delivered to the core shack, it was treated as described in section 12.1.

During the 2007 and 2008 drilling programs, the samples were flown out in canvas mega-bags via helicopter to a staging area at Tatogga Lake Resort. Here, the samples were placed in a locked container by Imperial Metals employees. The samples were shipped approximately once a week via Canadian Freightways Ltd. to the ACME Analytical Laboratories preparation lab in Smithers, British Columbia. Beginning in 2009, the rice bags were driven by truck to Iskut by an Imperial Metals employee and hand-loaded onto pallets in a secure location at the Bandstra Trucking Depot. Twice a week, the samples were delivered via Bandstra Transportation Systems to ACME's preparation lab in Smithers.

ACME preparation lab personnel recorded the shipment number, arrival time and security tag numbers for each sample shipment. The samples were dried at 60°C before being crushed using a jaw crusher to 80% passing. Samples were then split and pulverized in a ring pulverizer to 85% minus 200 mesh, rolled and bagged. ACME then arranged for the pulp samples to be delivered to the main ACME Analytical Laboratory in Vancouver, British Columbia for assaying. The remaining coarse reject samples were bagged and labeled with the appropriate sample number and sent via commercial vehicle transport to Imperial Metal's storage facility at the Mount Polley Mine in Likely, British Columbia. ACME Analytical Laboratories Ltd. is an ISO 9001 registered analytical laboratory.

All samples were analysed for gold, copper, iron and a 36-element geochemistry suite. Gold analysis was completed through fire assay fusion by ICP-ES (inductively coupled plasma) on a 30g sample. Copper and iron were analyzed by ICP-ES with an aqua-regia digestion. In addition, all samples were analysed using ICP-MS with an aqua-regia digestion for a 36-element suite. The 36 elements analysed in the ICP suite were: silver (Ag), aluminum (Al), arsenic (As), gold (Au), boron (B), barium (Ba), bismuth (Bi), calcium (Ca), cadmium (Cd), cobalt (Co), copper (Cu), chrome (Cr), iron (Fe), gallium (Ga), mercury (Hg), potassium (K), lanthanum (La), magnesium (Mg), manganese (Mn), molybdenum (Mo), sodium (Na), nickel (Ni), phosphorus (P), lead (Pb), sulphur (S), scandium (Sc), antimony (Sb), selenium (Se), strontium (Sr), thorium (Th), thallium (Tl), titanium (Ti), uranium (U), vanadium (V), zinc (Zn), tungsten (W).

14 Data Verification

14.1 Pre-2007 Data

Quality assurance and quality control ('QA/QC') programs began on the Red Chris Project during the 1994 drill program conducted by American Bullion and continued through to the 2003-2006 programs. The analytical quality of the 1994 and 1995 diamond drill programs were assessed by Barry Smee, Ph.D., P.Geol., of Smee and Associates Consulting Ltd. and presented in two separate reports (Smee, 1995 and Smee, 1996). During the 2003 drill campaign RCDC retained A.J. Sinclair, Ph.D., P.Eng. to evaluate the earlier work and comment on the 2003 QA/QC procedures and results. Both consultants had favourable conclusions on the QA/QC programs.

“The analytical data for the Red Chris Project is well controlled. Standards prove that the data is accurate to within acceptable limits. Duplicates show a very small rotational bias between the two laboratories, with Min-En being slightly high on copper, and slightly low on gold, when compared with Chemex. However, the differences are not significant and do not impact the validity of analysis.”
Smee, (1995)

A complete copy of Sinclair's findings is appended to 2004 feasibility study and available on Imperial Metals Web site.

<http://www.imperialmetals.com/i/pdf/2004TechnicalReport-RedChris2.pdf>

Sinclair updated his report in early 2007 to reflect his review of the data from the 2005 and 2006 programs and his conclusions were equally supportive of the analytical data received for that work.

All the past drilling programs at the Red Chris Project have well documented procedures for quality assurance and quality control. Checks on standards in various grade ranges have shown acceptable accuracy at both the primary analytical laboratories. Blank samples reported low values at or near the detection limit indicating the absence of contamination of material during preparation. Duplicate pulps sent to second labs have shown no significant analytical bias. The analysis of 'blind' duplicates by the primary lab (IPL) has shown the data are unbiased and have a moderate level of random analytical error. Re-analysis of 2nd half cores have shown sampling variability to be random and as a result should be minimized during the resource estimation. In the author's opinion the pre-2007 assay data at Red Chris are both suitable and of the quality necessary to use in a Resource Estimate.

14.2 2007-2009 Quality Assurance and Quality Control Program

The QA/QC program from 2007 to 2009 involved the random placement of a duplicate (DUP), blank (BLK) and standard reference samples (STD) within every 17 consecutive core samples. Three standards were used to reflect low, medium and high grades. Table 14.2 summarizes the regular mainstream samples (MS) and QA/QC samples (duplicates, standards and blanks) analysed during the 2007, 2008 and 2009 drilling programs at Red Chris.

Table 14.2 QA/QC Sample Summary of Drilling Programs by Year

YEAR	MS	DUP	STD	BLK	TOTAL
2007	1939	114	114	114	2281
2008	917	54	53	54	1078
2009	4835	284	282	281	5682
ALL	7691	452	449	449	9041

The standard reference material used during the 2007 drilling program was prepared by CDN Labs of Surrey, British Columbia. The custom standards were originally prepared for use during Imperial Metals' 2007 Mount Polley exploration drilling program. The material used to prepare the standards was collected from the remaining rejects from the 2005 and 2006 drilling programs at Mount Polley. The rejects were selected based on assay intervals that would yield a low, medium and high copper and gold reference assay. CDN Labs prepared and packaged three homogeneous standards for use as assay standard reference material. The standards were certified by Barry Smee, Ph.D., P.Geo. of Smee and Associates Consulting Ltd. The calculated assay values for the three standards are, 0.261% Cu (0.207g/t Au), 0.597% Cu (0.593g/t Au), and 2.37%Cu (1.05g/t Au).

The 2008 and 2009 drilling programs utilized the same low grade standard (MP06LG) used in the 2007 drilling program. Pre-processed and certified medium and high grade copper/gold standards were purchased from CDN Labs. The calculated assay values for these standards are, 0.451% Cu (0.570g/t Au) and 0.683% Cu (0.730g/t Au). The pre-made standards purchased from CDN Labs were also certified by Barry Smee, Ph.D., P.Geo. of Smee and Associates Consulting Ltd.

Copper and gold assays for the standard reference material were monitored for bias and precision. Standards met QA/QC requirements if the assayed values were within 3 standard deviations of the mean calculated standard value, as stated in the reference material certification. To monitor for bias, any two consecutive standard assay values could not be above two standard deviations on the same side of the mean calculated standard value. Failure to meet these requirements resulted in a re-assay of the failed standard, along with at least ten sequential samples above and below that standard. Re-assays were generally completed within two weeks of receipt of the original certificate. By the end of each program, no sample intervals had outstanding QA/QC issues.

Duplicate samples, taken to measure the precision of analysis, were randomly inserted into the sampling sequence within 17 consecutive core samples. These samples were made from quartering the half-core sample at the time of cutting or splitting. All of the assay results for the duplicate samples matched within reason. The calculated correlation coefficients are 0.99 for copper and 0.98 for gold.

Blank samples were randomly inserted into the sampling stream by Imperial geologists. The blank material consisted of crushed rock from a highways gravel pit located along the Likely highway in the central interior of BC. This material was bagged in poly ore bags in one kilogram samples. If a blank sample returned copper and gold assay values over a pre-determined threshold (0.05% Cu and 0.05g/t Au), the blank reject along with at least ten sequential core rejects (above and below the blank) would be re-processed and re-assayed. If the re-processed reject failed to meet the QA/QC requirements, the half-core was quartered and new samples in the affected range were re-submitted to the lab for processing and assaying. The majority of the blank samples assayed at or below the detection limit. Out of the 449 blank samples assayed between 2007 and 2009, 5 samples failed to meet QA/QC requirements. In each of these cases, the affected range of samples was re-processed and re-submitted to the lab for assaying. By the end of each program, all blank samples had met QA/QC requirements.

15 Adjacent Properties

In the immediate area of the Red Chris deposit the BC government mineral inventory database (Minfile) records a few mineral showings, most of which are low level geochemical anomalies or small showings with limited tonnage potential. Immediately to the west is the Gin Property where historical work was conducted to look for Eskay Creek style targets due to the presence of prospective stratigraphy, but no mineralization has been identified. To the east, the Eldorado/Bonanza property has received similar grassroots style exploration for porphyry targets, no significant mineralization has been identified.

The two properties of significance in the area are the GJ owned by NGEX Resources and Rok which is owned by Firesteel Resources Inc. The GJ property is located on the southern end of the Klastline Plateau, over 30 km to the west of Red Chris. The property is underlain by Stuhini Group, and overlain by Lower Jurassic, Hazelton Group. Intruding the volcano-sedimentary sequence are numerous small plugs and sills of diorite to monzonite composition. The largest of these is the Groat Stock which hosts porphyry copper-gold mineralization in at least four areas; the Donnelly, North Donnelly, GJ and North zones. GJ has a 43-101 compliant measured and indicated resource, at a cut-off of 0.20% copper, of 153.3 million tonnes grading 0.321% copper and 0.369 g/t gold. An additional inferred resource, at a cut-off of 0.20% copper, is 23 million tonnes grading 0.26% copper and 0.31 g/t gold (NGEX Resources website).

The Rok property is north of Coyote Creek, to the northwest of Red Chris, with a relatively small area of mineralization exposed at surface. Much of the prospective area is covered by a thick package of Toodogonne volcanics thought to be younger than the age of mineralization emplacement, so the extent of the copper-gold mineralization is not known. The mineralization observed occurs in structurally-controlled quartz-vein stockworks, however there is no evidence of a large intrusive body to host significant porphyry style deposit. A blind and untested magnetic anomaly in the valley bottom provides encouragement that a large hydrothermal system may be present (see figure 15.1 for locations).

Figure 15.1 Red Chris Adjacent Property Map

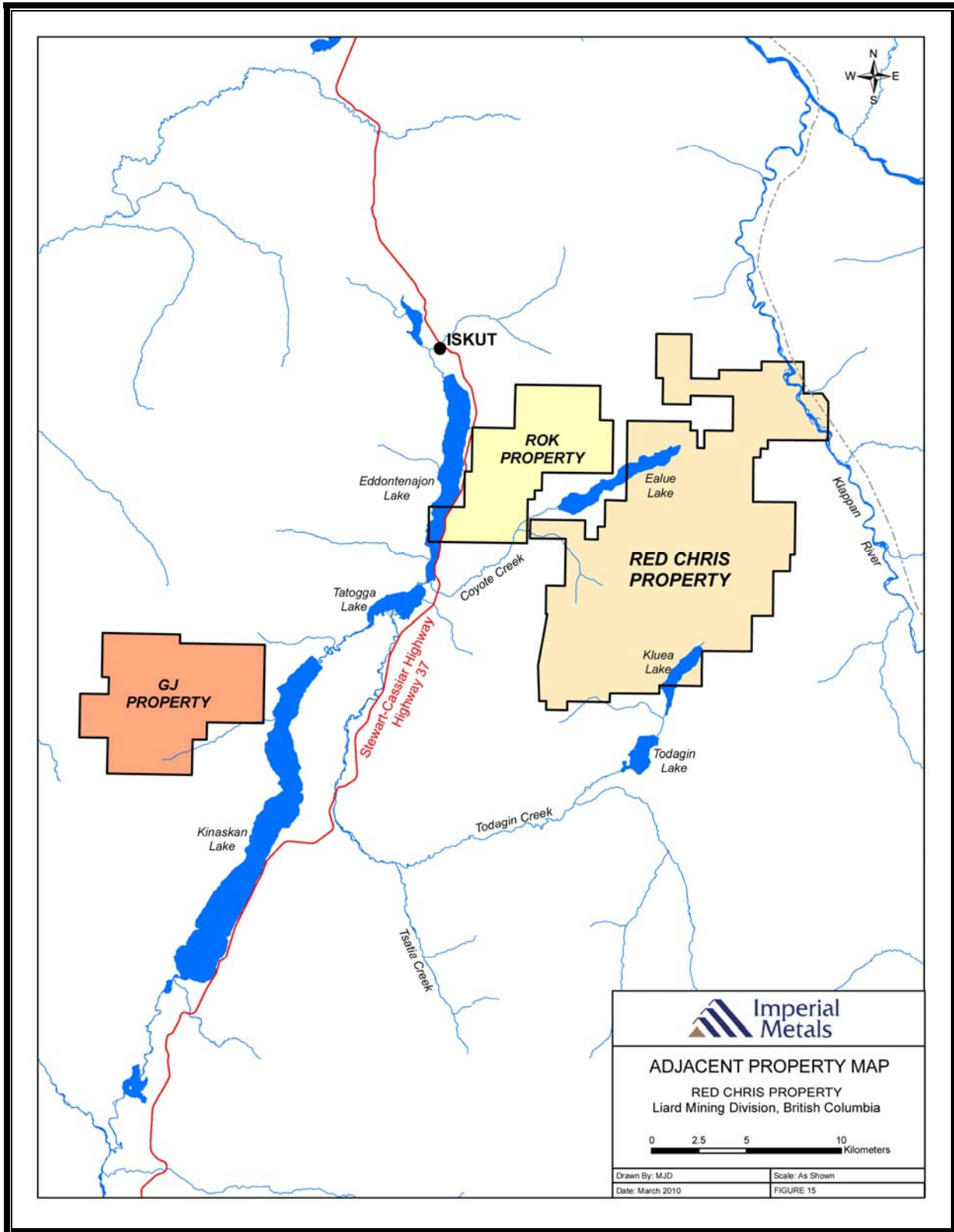

16 Mineral Processing and Metallurgical Testing

Mineral processing testwork conducted by Lakefield Research Limited in 1995 and 1996 and earlier work by G&T Metallurgical Services Ltd., indicated the Red Chris deposit responds well to processing by conventional crushing, grinding and flotation to produce a commercial grade copper-gold concentrate.

These earlier programs formed the basis for the 2004 Feasibility Study program conducted on newly acquired drill core from the 2003 exploration program. A comprehensive metallurgical test program was completed for the 2004 Feasibility Study. The Study used various processing schemes on representative samples of Red Chris ores.

The Mineral processing and metallurgical test work was done principally at Lakefield and G&T Metallurgical Services, utilizing both laboratory and pilot scale tests. The tests were conducted in logical sequence to determine an acceptable commercially viable process. These test are summarized in section 16.1.

In January, 2010 Imperial Metals contracted G&T to initiate a scoping level study to examine the metallurgical characteristic of the deeper areas of the East Zone. This study used core from the 2008/2009 drilling programs (see section 16.3). The study is attached in Appendix A.

16.1 2004 Feasibility Study Testing

The 2004 Feasibility Study comprehensive test work programs was performed at G&T using fresh drill core from the 2003 exploration program. This material was selected to be representative of the material to be mined in the open pit contemplated in the Feasibility Study. The G&T metallurgical program was carried out in following three phases:

- Phase 1: Flowsheet Development;
- Phase 2: Recovery Variability; and
- Phase 3: Pilot Plant Concentrate Production

The results of the G&T 2004 metallurgical programs were used as the basis for the design and consumption parameters for the Red Chris concentrator. The G&T 2004 programs confirmed previous test work that the mill flow sheet for Red Chris would utilize conventional processing techniques for a porphyry copper-gold flotation plant using:

- SAG and ball mill grinding to produce a nominal 150 μ product to rougher flotation;
- Rougher flotation with an 18 minute retention time;
- Regrind of the rougher flotation concentrate to a nominal 25 μ product to cleaner flotation;
- Two stages of cleaner flotation to produce a final copper-gold concentrate; and
- Thickening and dewatering of the final copper-gold concentrate for transport to off-site smelting facilities.

The proposed flow sheet is expected produce an average 27% copper concentrate at a copper recovery of 87%. Test work indicates that the gold will track the chalcopyrite, pyrite and gangue in near equal portions throughout the process resulting in a gold concentrate ranging from 5g/t to 25g/t of concentrate at an average recovery of 50%.

16.1.1 Sample Selection and Metallurgical Composites

Drill core from the 2003 exploration program was used for all 2004 metallurgical testing. A ¼ split of selected sections from 23 holes was assembled into composites representing possible mining sequences. (see table 16.1a and 16.1b).

Three holes were drilled with HQ coring, #256, #256A and #283, for the purpose of obtaining a larger volume sample in each of the Main and East Zones. The remaining core from holes 256A and 283 was used for grinding and work index studies.

The samples selected for metallurgical testing cover the majority of production within the East and Main ore zones with emphasis spatially on zones in the first nine years of the seventeen year mining production phase. The original sampling strategy was based on a mine plan and production level that has been superseded by the one forming the basis of this technical report. Additional sampling and metallurgical testing may be required to more fully characterize the metallurgical response of the entire deposit and link it to the current mine plan. Over the mine life, the East Zone will account for about 27% of mine production, but will average about 40% in the first six years of operation.

Portions of the drill core were blended to make up a series of composite samples for metallurgical testing. Composites MZ-1, -2, -3 and EZ-1, -2, -3, -4 represent horizontal layers within each zone that would be mined sequentially. Composite EZ-5 was a high grade sample prepared to study the effect of metallurgy at higher grades. Composites MZ-4, MZ-5 and EZ-6 are lower grade, representing material that will be stockpiled during the seventeen year mining phase and processed at a later date in years 18 through 25. Table 16.1a lists actual composite head grades used in the metallurgical testing. Over the mine life the average copper and grades of Main and East zones are expected to average about 0.42% and gold 0.30-0.39g/t respectively. In the first nine years of production the Main zone copper grade will average about 0.46% and the average grade of the Main zone metallurgical composite is about 0.47%. The average grade of the East Zone composite and global sample is relatively higher than the current production plan. Additional sampling and metallurgical work has been recommended to test grades closer to the mine plan for this zone.

Table 16.1a Individual Metallurgical Composite Head Grades

Composite Designation	Zone	Description	% Cu	Au g/t
MZ-1	Main	1410m – Surface	0.55	0.22
MZ-2	Main	1320-1410m	0.54	0.45
MZ-3	Main	1230-1320m	0.61	0.54
MZ-4	Main	Low Grade	0.28	0.18
MZ-5	Main	Medium Grade	0.36	0.25
EZ-1	East	1425m – Surface	0.84	0.53
EZ-4	East	1335-1425m	0.68	0.52
EZ-3	East	1245-1335m	0.58	0.57
EZ-2	East	1140-1245m	0.82	0.79
EZ-5	East	High Grade	1.24	1.19
EZ-6	East	Low Grade	0.32	0.30

Two additional composites for metallurgical testing were prepared. The MZ-Global comprised a blend of equal portions by weight of MZ-1, MZ-2, MZ-3 and MZ-5. The EZ-Global comprised a blend of equal portions by weight of EZ-1, EZ-2, EZ-3 and EZ-4. Table 16.1b lists actual composite head grades used in the metallurgical testing.

Table 16.1b Global Metallurgical Composite Head Grades

Composite Designation	Zone	Description	% Cu	Au g/t
MZ-Global	Main	MZ-1, MZ-2, MZ-3, MZ-5	0.50	0.42
EZ-Global	East	EZ-1, EZ-2, EZ-3, EZ-4	0.74	0.69

16.1.2 Mineralogy

Pyrite, chalcopyrite and lesser bornite are the principal sulphide minerals in the portion of the Red Chris deposit planned to be mined by the 2004/2005 mine plan. Minor covellite occurs as inclusions in pyrite, and molybdenite, sphalerite and galena occur locally in trace amounts. Gold, second in economic importance to copper, occurs as native and electrum, genetically-associated with the copper and pyrite mineralization.

The Main Zone mineralogy consists predominantly of chalcopyrite and pyrite with an average pyrite: chalcopyrite ratio of 10:1. The East Zone mineralogy has an average pyrite: chalcopyrite ratio of 4:1, with significant amounts of bornite present. The non-sulphide gangue minerals include a mixture of sericite, quartz, ankerite, dolomite, illite and magnesite. There are no oxide copper minerals present in the material tested.

Gold occurrence is higher in the East Zone, and relative to the Main Zone, it is more dominantly associated with copper sulphides than pyrite. While the basic mineralogy of occurrence is similar throughout both zones this results in better gold recoveries in East Zone. Table 16.1c lists the mineralogy of the metallurgical composites.

Table 16.1c - Metallurgical Composite Mineralogy

Composite	Percent Mineral Content (by weight)			Non-sulphide Gangue	Pyrite/Chalcopyrite Ratio
	Chalcopyrite	Pyrite	Bornite		
MZ-1	1.6	12.0	-	86.4	7.5
MZ-2	1.5	14.2	-	84.3	9.5
MZ-3	1.7	14.0	-	84.4	8.2
MZ-4	0.7	11.1	-	88.1	15.9
MZ-5	1.0	13.3	-	85.7	13.3
MZ-Global	1.5	13.4	-	85.2	8.9
EZ-1	2.0	10.1	0.2	87.6	5.1
EZ-4	1.8	7.9	0.1	90.2	4.4
EZ-3	0.8	2.1	0.5	96.6	2.6
EZ-2	0.8	3.3	0.8	95.0	4.1
EZ-5	2.6	8.9	0.5	88.0	3.4
EZ-6	0.8	8.5	<0.1	90.7	10.6
EZ-Global	1.4	5.9	0.4	92.4	4.2

16.1.3 2004 Metallurgical Test Program

The program of flowsheet development studies and metallurgical response was based on the following series of objectives:

- Study the mineral composition and fragmentation characteristics of several ore composites from the Main and East Zones, representing material to be processed during the early years of the operation.
- Devise a set of common treatment parameters for processing the Red Chris ore types, including flotation feed sizing, regrind product sizing, reagent regime and flowsheet configurations.
- Conduct a series of work index tests to determine ore hardness variation for mill sizing and power requirements.
- Conduct modal assessments on groups of cycle test products to determine if further enhancements in metallurgical performance of the ores would be technically feasible.
- Assess the concentrate quality with regard to mineral composition and minor element concentrations.
- Using optimum treatment parameters, perform a series of standard tests on a variety of samples throughout the orebody to determine the variation in expected metallurgy.

16.1.4 Mineral Liberation Characteristics

A primary grind of 150 micron K_{80} was determined as optimum for the Red Chris ore. At this feed sizing, 50% of the chalcopyrite and bornite particles are liberated, along with 90% pyrite liberation and 95% non-sulphide gangue minerals. These liberation figures are within the typical range of standard industry practice. The average liberation of minerals in the flotation feed of twenty two porphyry copper-gold deposits in G&T's data base at a primary grind size of 185 microns K_{80} was 55% for copper sulphides, 65% for pyrite and 92% for non-sulphide gangue minerals.

The Red Chris ore is finer grained when compared with many porphyry copper-gold deposits, and as such will require a slightly finer grind size. This is also evident in the 24 micron regrind size selected for the flotation cleaner circuit feed. A primary grind of 105 micron K_{80} increased the recovery, however, this is more than off-set by an additional 3.5MW of power required for grinding or a reduction in throughput. A simple economic study confirmed this, using typical power costs and a net smelter revenue value for copper of 90 cents. Testing at a coarser 200 micron K_{80} resulted in a 5% recovery loss. The 150 micron K_{80} was considered the optimum level for this application. However, the economic primary grind selection could be lowered as copper prices have improved significantly since the feasibility report was written.

16.1.5 Rougher and Cleaner Flotation

A total of 129 bench tests followed by 31 locked cycle flotation tests were conducted studying pulp density, pH, reagent dosage, flotation residence time and grind size effect. Table 16.1d lists the operating parameters required to achieve optimum performance. Although the mineralogy between the two zones is different, similar operating parameters will be used with no loss in performance.

Table 16.1d Flotation Parameters

pH	Lime	Roughers	10.5
		Cleaners	12
Collector	Potassium Amyl Xanthate	Roughers	0.006 kg/t
		Cleaners	0.005 kg/t
Frother	MIBC		As req'd
Flotation Time	Lab Time	Roughers	9 min.
		Cleaners	9-11 min.
Flotation Density		Roughers	33-35% solids

Typical operating practice in many porphyry copper operations is to produce a 10 – 15% Cu rougher concentrate by pulling 4 – 5% mass. Current testwork indicates the Red Chris ore requires a 15 – 20 % mass pull resulting in a rougher concentrate grade of 3% Cu in order to achieve the same recovery. The regrind circuit power has been specified based on a design weight recovery of 15%.

A series of regrinding tests were conducted to investigate the possibility of preferential or distributed regrinding power, and the benefit of pulp conditioning. The tests involved by-passing part of the higher grade rougher concentrate, pre-cleaning prior to regrinding and classification prior to regrinding.

None of the modified circuits produced any improvement in results over those of the conventional regrinding circuit. Testing indicated regrinding to a relatively fine liberation sizing of $K_{80} = 24$ microns was potentially required to obtain optimum final grade and recovery, but this is mainly based on a consideration of Main Zone metallurgy. More testwork was recommended by G&T to optimize regrind size selection and power.

The duplicate tests listed in the table 16.1e indicate a slightly higher concentrate grade was achieved using the modified circuit. However, when the higher rougher concentrate feed grade effect is taken into account, the results are very similar.

Table 16.1e Regrind Circuit versus Metallurgy

		Rough Con		Cleaner Circuit	
Test	Sample	% Cu	% Cu	% Cu Rec	% Au Rec
1522-21	Modified RG Circuit	15.4	27.4	92.6	65.1
1522-22	Modified RD Circuit	17	25	91.8	57.5
1522-29	Conventional RG Circuit	14.8	24.1	91.4	60.6
1522-30	Conventional RG Circuit	15.3	25.4	92.5	62.7

16.1.6 Gold Occurrence

Gold occurs with both the copper sulphides and pyrite. Very little is associated with the non-sulphide gangue minerals as illustrated in the Gold Recovery Partition Table 16.1f. The differences recorded in gold recoveries for the East and Main Zone composites are entirely attributable to a much larger proportion of gold tracking the pyrite in the Main Zone composites.

Table 16.1f Gold Recovery Partition

Composite	Gold Recovery Partition Coefficients			Statistic R ²
	Cu Sulphides	Pyrite	Total	
MZ-1	0.45	0.52	0.97	0.98
MZ-2	0.54	0.43	0.97	0.98
MZ-3	0.57	0.41	0.98	0.98
MZ-4	0.36	0.62	0.98	0.98
MZ-5	0.47	0.53	1	0.99
EZ-1	0.69	0.29	0.98	0.99
EZ-4	0.66	0.32	0.98	0.99
EZ-3	0.73	0.25	0.98	0.99
EZ-2	0.75	0.23	0.98	0.99
EZ-5	0.77	0.22	0.99	0.99
EZ-6	0.56	0.41	0.97	0.99

16.1.7 Gravity Concentration Tests

Gravity concentration testwork was performed on global composites for both ore zones using a Knelson concentrator to examine the potential for gold recovery. This test work resulted in minimal gold recovery and no further work was performed and the inclusion of a gravity stage was not recommended in the flow sheet.

16.1.8 Work Index and Ore Hardness

A total of 64 ball mill / rod mill grinding work index tests were performed by five separate laboratories. G&T Metallurgical Engineers performed 49 of the tests using both the Bond Work Index (“WI”) method and the Comparative Work Index method. Four tests were conducted to confirm the validity of the Comparative Work Index method. On a Main Zone composite the Bond WI was 14.0 kW-hrs/tonne compared with 13.5 kW-hrs/tonne using the Comparative WI method. Similarly, on an East Zone composite, the Bond WI was 14.1 kW-hrs/tonne compared with 14.2 kW-hrs/tonne using the Comparative WI method.

Thirty three samples were tested in the Geometallurgical Ore Mapping Program designed to establish the metallurgical variation within the two zones. All samples were subjected to the Comparative Work Index test. The work index of the Main Zone averaged 14.8 kW-hrs/tonne with a range of 11.5 – 16.6 kW-hrs/tonne. The East Zone averaged 16.4 kW-hrs/tonne with a range of 10.8 – 22.1 kW-hrs/tonne.

During the first year of mining, the weighted calculation of 60% Main Zone and 40% East Zone provides a work index of 14.0 kW-hrs/tonne. In year 2, the average work index increases slightly to 14.3 with the East Zone contributing 31% of the feed. For years 3 to 5 inclusive, the average work index increases to 15.5 kW-hrs/tonne due to the gradual hardness increase at depth. Beyond year 7, test work indicates a further increase in hardness.

An average 16.1 kW-hrs/tonne ball mill work index was used to calculate power requirements for mill sizing at 30,000 tonnes per day.

16.1.9 Metallurgical Recoveries

The results of G&T's locked cycle testwork are presented in Table 16.1g. The flotation locked cycle testing produced a copper grade-recovery profile relationship for both zones which is summarized in Table 16.1h.

Table 16.1g Locked Cycle Test Results

Ore Zone	Sample & Product	Mass %	Assay - % or g/t		Recovery-%	
			Copper	Gold	Copper	Gold
MZ-1	Feed	100.0	0.54	0.2	100	100
	Concentrate	1.9	26.1	4.34	89	40
MZ-2	Feed	100.0	0.53	0.42	100	100
	Concentrate	1.8	26	10.8	90	47
MZ-3	Feed	100.0	0.58	0.53	100	100
	Concentrate	2.0	26.2	12.98	88	48
MZ-4	Feed	100.0	0.25	0.16	100	100
	Concentrate	0.8	25.9	5.59	84	29
MZ-5	Feed	100.0	0.32	0.21	100	100
	Concentrate	1.4	21	6.33	89	41
MZ-Global	Feed	100.0	0.5	0.34	100	100
	Concentrate	1.7	26.6	9.27	90	46
MZ Average	Feed	100.0	0.45	0.31	100	100
	Concentrate	1.6	25.4	8.59	89	44
East						
EZ-1	Feed	100.0	0.84	0.59	100	100
	Concentrate	3.0	24.8	12.2	89	63
EZ-2	Feed	100.0	0.81	0.76	100	100
	Concentrate	1.9	37.0	26.2	88	66
EZ-3	Feed	100.0	0.58	0.51	100	100
	Concentrate	1.4	35.2	22.6	84	61
EZ-4	Feed	100.0	0.67	0.54	100	100
	Concentrate	2.2	26.6	14.1	88	58
EZ-5	Feed	100.0	1.27	1.23	100	100
	Concentrate	3.7	31.8	23.7	91	70
EZ-Global	Feed	100.0	0.74	0.59	100	100
	Concentrate	2.5	26.0	15.1	89	65
EZ Average	Feed	100.0	0.74	0.65	100	100
	Concentrate	2.2	29.2	18.31	88	63

Table 16.1h Copper Grade-Recovery Profile

Final Concentrate Grade % Cu	Percent Copper Recovery	
	Main Zone	East Zone
25	90.8	90
26	90.3	89.9
27	89.8	89.7
28	89.1	89.4
29	88.2	89.2

The recoveries of copper to concentrate ranged from 85 to 90 percent while gold recoveries varied between 45 and 65 percent. Gold recovery in both zones was dependent on the head grades and pyrite content and higher in East zone.

Based on G&T’s results, and a production split of 73% and 27% between Main and East zones respectively, the overall life of mine metallurgy is summarized in table 16.1i.

Table 16.1i Copper Grade-Recovery Profile

Mass %	Assay - % or g/t		Recovery-%	
	Copper	Gold	Copper	Gold
1.8	26.4	11.2	88	49

This is in reasonable agreement with the overall mine plan recoveries of 87% copper and 50% gold at a 27% copper concentrate grade. Over the first five years of operation gold recovery is expected to vary in the range of 50 – 60% depending on mineralogy and grade, with an overall average of 56%.

Additional sampling and testwork is recommended to improve the correlation of metallurgy the production schedule forming the basis of this technical report. In addition the impact on recovery of storing low-grade ore for later processing should also be investigated. However this occurs only towards the end of the mine life.

16.1.10 Copper Concentrate

A pilot plant program was conducted at G&T Metallurgical Engineers with the objective of producing a final concentrate for use and testing by prospective buyers. Table 16.1j lists the full analysis, including minor elements, of a sample prepared in the ratio of 64% Main Zone and 36% East Zone. Hg and Sb are expected to incur penalties for being outside the limits set by some of the smelters.

Table 16.1j Copper Concentrate Analysis

Element	Symbol	Unit	Sample*		Average
			Analysis	Range **	
Copper	Cu	%	27.0		26 – 30
Gold	Au	g/t	17.3		5 – 25
Silver	Ag	g/t	42		25 – 100
Aluminum	Al	%	0.95		0.6 – 1.0
Antimony	Sb	ppm	756		400 – 900
Arsenic	As	ppm	130		80 – 250
Barium	Ba	ppm	44		12 – 45
Bismuth	Bi	ppm	<7		<8
Cadmium	Cd	ppm	16		12 – 22
CaO	CaO	%	0.66		0.4 – 0.9
Chlorine	Cl	%	0.01		0.01
Chromium	Cr	ppm	3		3 – 55
Cobalt	Co	ppm	20		10 – 25
Fluorine	F	ppm	87		40 – 190
Iron	Fe	%	28.8		23 – 33
Lead	Pb	ppm	439		200 – 1300
Manganese	Mn	ppm	213		40 – 500
Mercury	Hg	ppm	27		8 – 50
MgO	MgO	%	0.36		0.2 – 0.5
Molybdenum	Mo	ppm	166		20 – 170
Nickel	Ni	ppm	22		10 – 45
Phosphorous	P	ppm	115		40 – 225
Potassium	K	ppm	372		130 – 500
Selenium	Se	ppm	93		70 – 160
Silica	SiO ₂	%	6.6		3.5 – 7.0
Sodium	Na	ppm	274		65 – 300
Sulphur	S	%	29.8		28 – 35
Titanium	Ti	ppm	348		300 – 450
Zinc	Zn	ppm	1400		600 – 2000
Sizing	K ₈₀	µm	25		24 – 28

* Sample Analysis refers to the composite concentrate sample generated from the G&T Metallurgical Engineers pilot plant exercise, based on an ore mixture of 64% Main Zone and 36% East Zone

** Average Range is based on results of concentrates from the various Main Zone and East Zone composites tested during the metallurgical program.

16.2 Processing

In the 2004 Red Chris Feasibility Study ore was proposed to be processed through an on-site concentrator that will produce a copper-gold flotation concentrate that will be shipped out of the Province for smelting and refining. The nominal milling rate will be 30,000 tonnes per day. A simplified flowsheet is presented in Figure 16.2.

Figure 16.2 - Red Chris Simplified Flowsheet

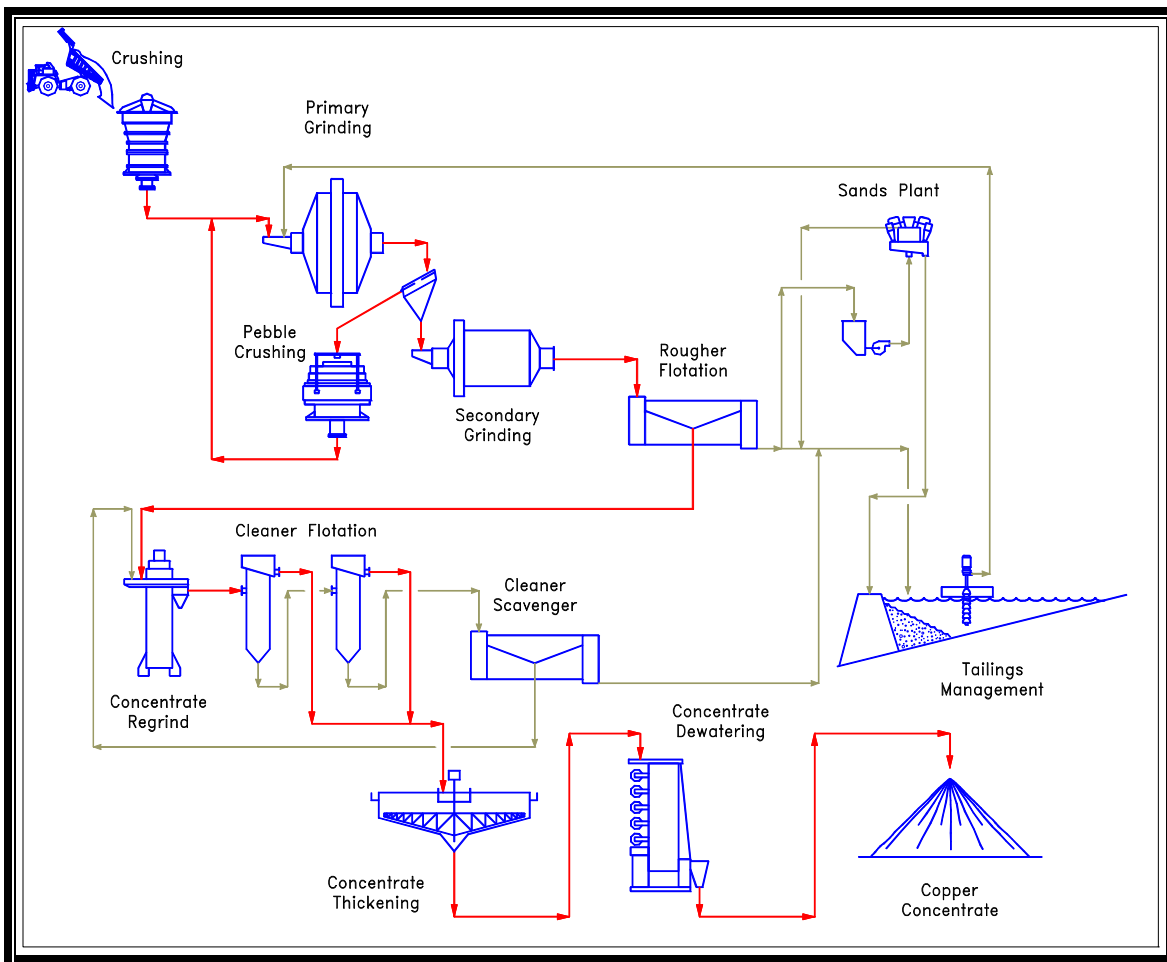

Details on ore the proposed methods for crushing, grinding, flotation and tailing handing can be found in the 2004 Feasibility Study. <http://www.imperialmetals.com/i/pdf/2004TechnicalReport-RedChris1.pdf>

16.3 2010 Preliminary Metallurgical Test Work on the Deep East Zone

In late 2009, two composite samples of deep East zone mineralization were put together to complete some preliminary metallurgical test work on these materials. The focus of this initial test work was not to optimize the flowsheet for these composites but to see how the samples would perform in the flowsheet proposed in the 2005 Feasibility Study. The primary objective of the study was to assess the mineralogical and metallurgical response of a new mineralized zone recently located during drilling at depth. The assessment was to be conducted with respect to the previously developed process for treating Red Chris mineralization.

Approximately 859 kilograms of sample, in the form of quarter drill core, were received for use in this study. From this material inventory, the two composites were constructed for use in this program, using approximately 135 kilograms of the drill core inventory. The program commenced mid January, 2010 and at the writing of this report had not been completed. An interim report was requested and there remains additional planned testing to complete this program.

The two samples collected were labeled, High Au to Cu, and High Bornite, and each was selected from intervals in recently drilled holes that had a high gold to copper ratio for the first sample and a high percentage of its copper mineralization in the form of Bornite in the second.

The following points summarized some of the key findings to date:

- The copper and gold grades of the composites selected for construction were considerably higher than previously tested samples.
- The samples contained much less pyrite than previously studied East zone samples. The copper sulphide liberations were between 64 and 69 percent when measured at 150µm K80. These values were much higher than observed for other samples and should result in efficient rougher flotation recovery of copper sulphides.
- One composite had similar hardness as previously measured samples at 14.6kWh/tonne. The Bornite East Composite was hard, averaging 16.7 kWh/tonne.
- Using the previously developed process flowsheet, metallurgical performance for copper and gold far exceeded the historical levels from previous programs. The flowsheet and test conditions remain un-optimized and simplifications to the process should be considered for this mineralization to reduce operating costs.
- Mineralogical analyses, specifically for gold, indicated most of the gold in the samples was associated with copper sulphides, or was liberated. These forms of gold were well recovered to the copper concentrate. There was evidence to suggest the small amount of gold lost to tailings occurred as tiny inclusions in non-sulphide gangue.

The chemical and mineral contents of the composites were determined using standard analytical techniques and QEMSCAN particle mineral analysis (PMA). The results of QEMSCAN analysis provided quantitative mineral content values for the array of sulphide minerals observed in the sample. A composite sample from the historic testing of shallower East zone mineralization is included on the Table 16.4 that highlights the differences in the deeper samples. The relevant data summary is presented in Table 16.3.

Table 16.3 Chemical and Mineral Contents

Element or Mineral	Symbol	Units	East Zone	East Zone	East Zone
			High Au-Cu	High Bornite	Global KM1428
Copper	Cu	%	2.9	1.4	0.7
Iron	Fe	%	5.9	4.6	7.1
Sulphur	S	%	3.7	0.85	-
Silver	Ag	g/t	6.0	6.4	-
Gold	Au	g/t	4.74	1.84	0.7
Weak Acid Soluble Copper	Cu Ox	%	0.022	0.024	-
Cyanide Soluble Copper	CuCN	g/t	0.073	0.94	-
Mineral					
Chalcopyrite	Cp	%	8.5	0.6	1.4
Bornite	Bn	%	<0.1	2.0	0.4
Chalcocite/Covellite	Ch/Cv	%	0.1	<0.1	<0.1
Pyrite	Py	%	2.6	0.2	5.9
Ankerite	Ank	%	7.5	16	-
Quartz	Qz	%	61	40	-
Micas	Mic	%	10	21	-
Other Gangue	Gn	%	10.4	20.4	92.4

Notes: a) Detailed head assay and mineralogical content data are located in Appendix IV and V.

b) Detailed copper distribution for the NOX Composite can be located in Appendix IV.

Both samples contained relatively high values of copper and gold compared to previously studied East Zone samples, as shown in Table 16.3. The new composite samples also display relatively low levels of pyrite compared to the amount of copper sulphides.

The rougher tails from the locked cycle testing of the high Au-Cu East Zone were tested for Acid Base Accounting. The two tests showed the rougher tails to have a neutralization potential ratio (NPR) of 26.9 and 85.0 (see appendix A, table IV-5)

The High Au-Cu East Zone composite exhibited almost perfect copper metallurgical performance. Copper recoveries of 97 to 98 percent were achieved with a rougher mass recovery of about 20 percent. Similarly, gold was also well recovered to the rougher concentrate. On average, between 91 and 93 percent of the gold in the feed was recovered into a rougher concentrate containing 20 percent of the feed mass. Both copper and gold rougher flotation performances were well above average for deposits of this type. Clearly this composite could be processed at a much coarser feed sizing.

The best cleaner flotation response for the high Au-Cu East composite was achieved in Test 11. In this test, additional collector (3418A) was added along with Potassium Amyl Xanthate. The superior performance of this test would suggest that the previous tests may have had insufficient collector dosages. Overall the results were spectacular, copper was 96 percent recovered into a concentrate grading about 33 percent copper. Similarly, gold was 88 percent recovered into the copper concentrate. The gold grade in the concentrate was about 50 g/tonne.

The Bornite East Zone composite also performed well. Copper in the feed was 93 to 95 percent recovered into the rougher concentrate at a rougher mass recovery of about 10 percent. Gold recoveries to the rougher concentrate were lower; averaging about 88 percent at 10 percent feed mass recovery.

The cleaner test results for the Bornite East Zone were more consistent. On average, about 90 percent of the copper in the feed was recovered into a concentrate grading about 45 percent copper. Gold performance was more variable, but on average, about 75 percent of the gold was recovered into the copper concentrate. The gold grade was about 60 g/tonne in the concentrate.

In locked cycle testing, copper recovery to the final concentrate, from the High Gold Copper Ratio East Zone sample was 98 percent, with a copper concentrate grade of 29 percent. Gold recovery to the final concentrate was 90 percent, grading 47 g/tonne gold. Copper from the High Bornite East Zone sample was 93 percent recovered into a final concentrate, grading 49 percent copper. Gold was 85 percent recovered into the final concentrate, grading at a high 69 g/tonne gold.

The observed performance was superior to results achieved on previously tested East Zone samples. The high grade of copper and gold, low pyrite content and favorable fragmentation properties of the composites make these composites respond well at the previously developed Red Chris process conditions. Overall, the batch test performance for these high grade composites was very good using the previously developed flowsheet. This flowsheet, designed for low grade ores, with considerably more pyrite in the feed, could likely be optimized to reduce operating costs. Adopting coarser primary and regrinding sizes, combined with lower pulp pH could reduce costs, with negligible effect on metallurgical performance.

17 Mineral Resource Estimate

17.1 Updated Mineral Resource Estimate for the Red Chris Deposit

A new block model was completed in April 2010 to update the 2004 resource estimate for the Red Chris deposit. The new model included all new 2007 to 2009 drilling. The assays for holes RC10-355 and RC10-360 were complete before this report was finished and have been included also. At a 0.3% copper cutoff the updated resource shows an increase in measured and indicated tonnage of 30%, with an increase in copper grade of 17% and gold grade of 50%. In the inferred category the updated model shows an increase in tonnage of 89%, with an increase of 24% in copper and 60% increase in gold. The large increase in inferred resources is due mainly to the new deep drilling. More drilling is planned to expand the ore body at depth and to convert the inferred resources to measured and indicated.

The new block model and resources have been calculated and reviewed by Art Frye, Operations Manager for the Mount Polley Mine, and by Greg Gillstrom, P. Eng. Senior Geological Engineer, who has been designated as its 'Qualified Person' for this purpose. Preliminary data review and specific gravity work was done by Dave Smithies, P. Eng., Project Engineer for Imperial.

Figure 17.1 Red Chris 2010 Block Model

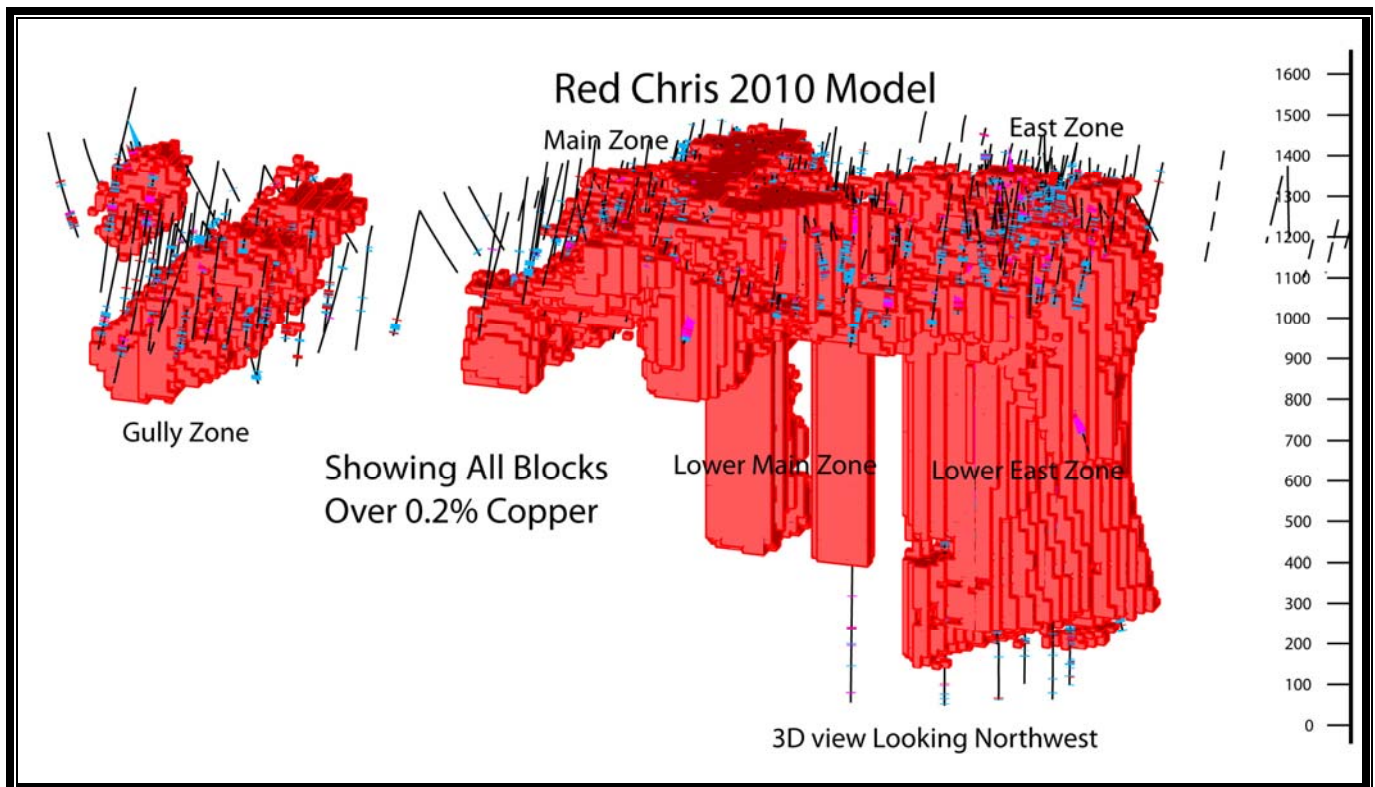

Table 17.1a Red Chris Resources: Total (Measured + Indicated) and Total Inferred

MEASURED + INDICATED MINERAL RESOURCES						INFERRED MINERAL RESOURCES				
Cut-off	Tonnes	Cu%	Au g/t	Pounds Cu	Oz Gold	Tonnes	Cu%	Au g/t	Pounds Cu	Oz Gold
	X 1,000			X 1,000	x 1,000	X 1,000			X 1,000	X 1,000
>=0.10	619,417	0.38	0.36	5,139,790	7,162	619,129	0.30	0.32	4,120,730	6,429
>=0.20	489,151	0.43	0.42	4,674,389	6,634	437,939	0.36	0.39	3,497,936	5,433
>=0.30	312,571	0.54	0.55	3,710,414	5,564	237,701	0.46	0.50	2,396,943	3,794
>=0.40	189,526	0.66	0.74	2,775,182	4,484	105,613	0.60	0.69	1,398,864	2,332
>=0.50	125,310	0.78	0.93	2,147,043	3,728	60,326	0.72	0.87	957,825	1,687
>=0.60	86,957	0.88	1.11	1,685,773	3,115	39,197	0.81	1.02	702,112	1,282
>=0.70	57,585	1.00	1.34	1,267,272	2,479	22,470	0.94	1.19	464,170	863
>=0.80	39,207	1.12	1.56	965,359	1,961	14,317	1.05	1.37	331,485	629
>=0.90	27,299	1.24	1.78	744,212	1,558	8,814	1.18	1.56	228,447	442
>=1.00	20,083	1.34	1.96	593,780	1,266	6,388	1.26	1.69	177,860	347
>=1.10	15,633	1.42	2.08	491,073	1,045	4,561	1.35	1.79	135,958	263
>=1.20	12,072	1.51	2.21	401,064	858	3,814	1.39	1.84	116,922	225
>=1.30	8,973	1.60	2.39	316,025	690	2,387	1.47	1.92	77,533	147
>=1.40	6,568	1.69	2.51	244,377	531	1,393	1.56	1.95	48,047	87
>=1.50	4,806	1.78	2.69	188,175	415	796	1.65	2.02	28,948	52

Table 17.1b Red Chris Resources: Total Measured and Total Indicated

MEASURED MINERAL RESOURCES						INDICATED MINERAL RESOURCES				
Cut-off	Tonnes	Cu%	Au g/t	Pounds Cu	Oz Gold	Tonnes	Cu%	Au g/t	Pounds Cu	Oz Gold
	X 1,000			X 1,000	x 1,000	X 1,000			X 1,000	X 1,000
>=0.10	534,267	0.38	0.37	4,514,679	6,311	85,150	0.33	0.31	625,112	851
>=0.20	424,693	0.44	0.43	4,124,308	5,863	64,458	0.39	0.37	550,081	771
>=0.30	277,190	0.54	0.56	3,318,846	4,962	35,381	0.50	0.53	391,568	602
>=0.40	171,002	0.67	0.73	2,510,390	4,023	18,524	0.65	0.77	264,792	461
>=0.50	113,545	0.78	0.92	1,948,007	3,350	11,765	0.77	1.00	199,036	377
>=0.60	78,659	0.88	1.11	1,528,268	2,800	8,299	0.86	1.18	157,505	315
>=0.70	52,028	1.00	1.34	1,148,837	2,234	5,558	0.97	1.37	118,435	246
>=0.80	35,491	1.12	1.55	877,028	1,773	3,716	1.08	1.58	88,331	188
>=0.90	24,663	1.24	1.78	675,946	1,411	2,637	1.17	1.74	68,266	147
>=1.00	18,242	1.35	1.97	542,129	1,156	1,841	1.27	1.86	51,651	110
>=1.10	14,224	1.43	2.09	449,268	958	1,409	1.35	1.93	41,806	87
>=1.20	11,012	1.52	2.23	368,075	791	1,060	1.41	1.98	32,989	67
>=1.30	8,144	1.61	2.43	289,485	635	828	1.45	2.05	26,540	55
>=1.40	6,038	1.70	2.54	226,697	494	530	1.51	2.15	17,680	37
>=1.50	4,558	1.79	2.71	179,436	398	248	1.60	2.20	8,740	18

Table 17.1c Red Chris Resources: Main Zone (Measured + Indicated) and Inferred

Cutoff	Measured and Indicated				Inferred			
	Tonnes	Cu Cut	Au Cut	CuEq	Tonnes	Cu Cut	Au Cut	CuEq
0.1	351,101,216	0.310	0.218	0.406	150,768,992	0.277	0.252	0.386
0.2	267,052,240	0.357	0.252	0.468	116,432,672	0.311	0.288	0.435
0.3	155,434,960	0.435	0.315	0.574	59,160,856	0.368	0.359	0.522
0.4	73,895,264	0.534	0.391	0.708	12,369,420	0.460	0.438	0.650
0.5	35,600,392	0.633	0.476	0.846	2,256,180	0.564	0.569	0.814
0.6	16,470,779	0.736	0.582	1.002	521,520	0.629	0.607	0.895
0.7	7,637,612	0.845	0.702	1.171	0	0.000	0.000	0.000
0.8	3,927,120	0.942	0.813	1.329	0	0.000	0.000	0.000
0.9	1,880,520	1.051	0.954	1.514	0	0.000	0.000	0.000
1.0	941,580	1.163	1.111	1.717	0	0.000	0.000	0.000

Table 17.1d Red Chris Resources: East Zone (Measured + Indicated) and Inferred

Cutoff	Measured and Indicated				Inferred			
	Tonnes	Cu Cut	Au Cut	CuEq	Tonnes	Cu Cut	Au Cut	CuEq
0.1	130,134,560	0.369	0.344	0.520	82,839,152	0.285	0.276	0.406
0.2	100,235,304	0.431	0.402	0.609	61,047,932	0.329	0.317	0.468
0.3	62,637,972	0.541	0.503	0.764	29,997,330	0.412	0.381	0.579
0.4	36,038,728	0.688	0.638	0.971	11,971,702	0.523	0.469	0.730
0.5	23,378,300	0.820	0.762	1.160	5,144,760	0.627	0.559	0.875
0.6	16,443,404	0.936	0.883	1.332	2,142,120	0.747	0.699	1.061
0.7	11,732,276	1.051	1.006	1.504	1,054,380	0.855	0.872	1.254
0.8	8,727,524	1.155	1.109	1.656	484,620	0.987	1.161	1.532
0.9	6,198,213	1.280	1.224	1.837	233,760	1.141	1.422	1.819
1.0	4,543,825	1.402	1.337	2.015	150,240	1.250	1.547	1.992

Table 17.1e Red Chris Resources: Gulley Zone (Measured + Indicated) and Inferred

Cutoff	Measured and Indicated				Inferred			
	Tonnes	Cu Cut	Au Cut	CuEq	Tonnes	Cu Cut	Au Cut	CuEq
0.1	13,178,521	0.334	0.302	0.470	150,309,376	0.231	0.264	0.334
0.2	10,735,800	0.375	0.326	0.523	75,116,592	0.309	0.308	0.435
0.3	6,615,000	0.455	0.367	0.623	32,906,030	0.396	0.351	0.544
0.4	3,846,540	0.532	0.399	0.720	12,817,156	0.475	0.385	0.637
0.5	1,900,140	0.622	0.444	0.839	3,719,884	0.562	0.500	0.768
0.6	1,017,720	0.686	0.481	0.931	605,069	0.655	0.547	0.938
0.7	334,020	0.770	0.527	1.064	116,476	0.734	0.559	1.073
0.8	100,560	0.834	0.603	1.171	0	0.000	0.000	0.000
0.9	0	0.000	0.000	0.000	0	0.000	0.000	0.000
1.0	0	0.000	0.000	0.000	0	0.000	0.000	0.000

Table 17.1f Red Chris Resources: Lower Main (Measured + Indicated) and Inferred

Cutoff	Measured and Indicated				Inferred			
	Tonnes	Cu Cut	Au Cut	CuEq	Tonnes	Cu Cut	Au Cut	CuEq
0.1	50,040	0.235	0.305	0.367	87,443,280	0.299	0.359	0.456
0.2	50,040	0.235	0.305	0.367	72,649,504	0.327	0.398	0.501
0.3	0	0.000	0.000	0.000	38,227,320	0.389	0.460	0.590
0.4	0	0.000	0.000	0.000	7,372,560	0.599	0.849	0.970
0.5	0	0.000	0.000	0.000	3,686,280	0.770	1.187	1.289
0.6	0	0.000	0.000	0.000	2,852,280	0.837	1.221	1.372
0.7	0	0.000	0.000	0.000	2,185,080	0.888	1.181	1.405
0.8	0	0.000	0.000	0.000	2,051,640	0.899	1.182	1.416
0.9	0	0.000	0.000	0.000	583,800	0.996	1.465	1.637
1.0	0	0.000	0.000	0.000	316,920	1.025	1.517	1.689

Table 17.1g Red Chris Resources: Lower East (Measured + Indicated) and Inferred

Cutoff	Measured and Indicated				Inferred			
	Tonnes	Cu Cut	Au Cut	CuEq	Tonnes	Cu Cut	Au Cut	CuEq
0.1	124,952,280	0.575	0.781	0.923	147,768,288	0.411	0.461	0.615
0.2	111,077,472	0.626	0.858	1.008	112,692,352	0.492	0.568	0.743
0.3	87,883,320	0.726	1.025	1.183	77,409,896	0.603	0.726	0.925
0.4	75,745,792	0.787	1.136	1.294	61,081,800	0.671	0.824	1.037
0.5	64,431,240	0.846	1.247	1.404	45,518,700	0.747	0.924	1.158
0.6	53,025,360	0.910	1.363	1.521	33,076,020	0.820	1.035	1.282
0.7	37,881,540	1.015	1.578	1.726	19,114,320	0.948	1.218	1.496
0.8	26,451,420	1.131	1.817	1.956	11,781,060	1.079	1.406	1.718
0.9	19,220,700	1.241	2.034	2.171	7,996,140	1.190	1.572	1.912
1.0	14,597,760	1.334	2.210	2.353	5,920,560	1.276	1.703	2.063

Figure 17.2 Red Chris 2010 Model Zones (Domains)

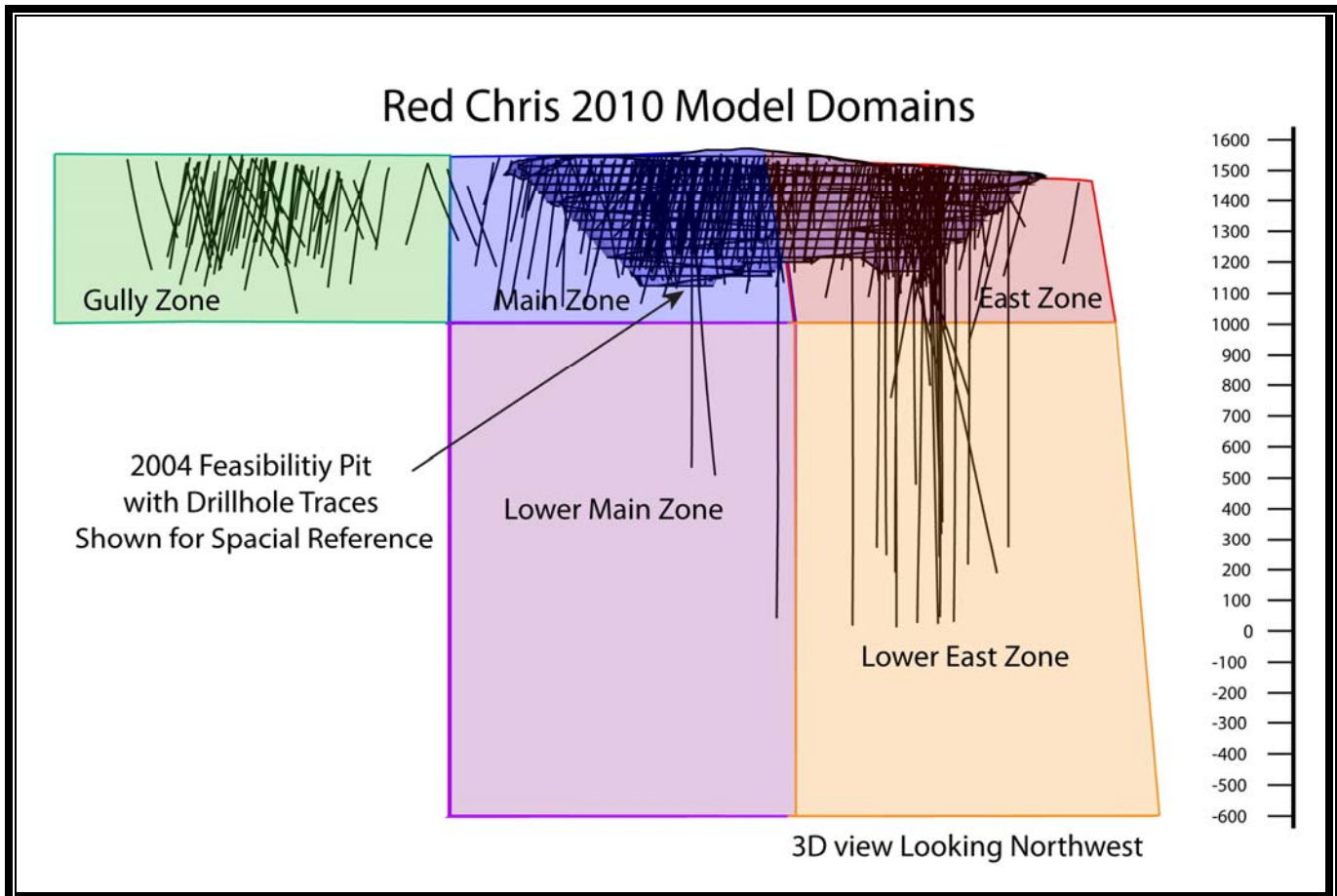

17.2 Modeling Methodology and Resource Classification

This Red Chris Deposit is divided into five geological zones (domains) for statistical modeling purposes as follows (see figure 17.2).

Table 17.2a Red Chris Model Zones

Red Chris model Zones		
Zone #	Name	Description
1	Main	Largest Central Zone (0 - 400m)
2	East	East of Main Zone (90 – 400m)
3	Gully	West of Main Zone
4	Lower East	East of Main Zone (400 – 1,000m)
5	Lower Main	Main Zone (400 – 1,000m)

A new block model for the Red Chris deposit was created in 2010 utilizing Mintec’s MineSight software for the modeling and SAGE software for the variography. The model is in UTM Coordinates (NAD83) with the lower SW corner (origin) at: 450,000N, 6,394,000E and 0m Elevation. The upper NE corner is at: 454,500N, 6,397,500E and 1725 Elevation. The block dimensions are 20m north by 20m east and 15m high and are considered appropriate for the size and nature of the deposit.

Table 17.3a Red Chris Model Dimensions

Red Chris 2010 Model				
	UTM Coordinate		Block size	Number of Blocks
	Min	Max		
East	450,000	454,500	20	225
North	6,394,000	6,397,500	20	175
Elevation	0	1,725	15	115

The drilling data set comprises of 357 drill holes with an associated copper and gold assays sampled every 2.5m for the entire hole and composited to 15m for modeling. New holes 07-335 through RC09-354 and RC10-355 and RC10-360, have been added to the data base since the previous resource update completed in 2004. Figure 11 shows the collar locations of all the drill holes, with the twenty two (22) new drill holes highlighted and labeled. As mentioned above the deposit was divided into five geological zones for statistical modeling purposes as seen in table 17.2a. The model methodology listed here is the same for all zones.

- All diamond drill holes are loaded into MineSight drillhole files where each assay interval is assigned a zone code matching the zone they fall within.
- Model blocks receive the same coding.
- Drill holes are composited to 15M bench lengths, except if their dip is less than 50 degree, in which case they are composited to 15M down hole lengths.
- Composites are not allowed to span zones.
- Statistics are carried out on the composites by zone to identify any outlier grades and to explore the grade correlation between copper and gold grades. The zones show strong grade correlation. Outlier grades are identified using Log Probability plots by zone and are capped to the grade selected.

Table 17.3b Red Chris Grade Composite Capping by Zone

Red Chris Grade Capping by Zone			
Zone	Max Grade	Capped	# Capped
Copper			
Main Upper & Lower	2.94	2.00	5
East	3.99	3.00	8
Gully	1.23	1.00	2
Lower East	5.16	4.00	5
Gold			
Main Upper & Lower	3.80	2.50	6
East	4.56	3.50	6
Gully	2.32	1.50	1
Lower East	14.29	10.00	4

- A code is interpolated to define an interpolation zone around each drill hole 100M along strike direction and 60M across and vertical to prevent over extrapolation of grades in areas of wide drill hole spacing.
- Indicator kriging is used to prevent the smoothing of high grades across well defined zones of waste. An indicator is assigned as 0 or 1 to the composites based on copper grade using a 0.10% cut-off ($<0.10 = 0$ and $\geq 0.10 = 1$). Variograms are run on the indicator by zone (see table 17.3d for results by zone).
- The indicators are kriged into a probability item in the block model resulting in each block having a value from 0.0 to 1.0 representing the probability of the block being high grade (see table 17.3e for all kriging parameters). Based on this probability value, an indicator is set in the block identifying the block as 0 = lowgrade/waste or 1 = highgrade. The composite indicators are then re-set to match the indicator in the block that they fall within. As a result waste grade composites within the ore zone are used in the ore zone interpolation (internal waste dilution)

and ore composites in the waste zone are used in the waste zone interpolation (Note: these composites have their range of influence limited).

- Copper and gold variography is performed for each model ore (indicator = 1) zone.
- Copper and gold grades both un-capped and capped are interpolated using zone and indicator matching. Two pass kriging is used in the ore zone. The first pass uses the full variogram range and the estimates are only used to provide an estimate of Inferred grades. The second pass limits the search radius to 67% of the variogram range with the vertical range further limited to +-22m (bench above and bench below). This pass provides the Measured and Indicated grades. The waste zone is interpolated using inverse distance squared. Any composites in the waste zone have their range of influence limited to 40M (see table 17.3c for tabulated classification logic).

Table 17.3c Red Chris Model Grade Capping Logic by Zone

Resource Classification				
	Minimum # Of Drill holes Used	Minimum # of Composites	Max Distance to Nearest Composite	Maximum Search Distance
Resource				
Inferred	1	3	130	Variogram range
Indicated	2	6	60	67% of the Variogram Range
Measured	2	6	45	67% of the Variogram Range

Table 17.3d Red Chris Model Variography Results by Zone

Red Chris Variography									
Using an Exponential Model Expressed in GSLIB logic									
Zone	Code	Nugget	Sill 1	Range Y	Range X	Range Z	Rot Z	Rot X	Rot Y
Ore Zone Indicator									
Main	1&5	0.4500	0.5500	78.2	171.3	122.6	2.0	8.0	4.0
East	2&4	0.1892	0.8108	79.6	454.8	315.9	-18.0	-7.0	-24.0
Gully	3	0.4500	0.5500	78.2	171.3	122.6	2.0	8.0	4.0
Copper									
Main	1&5	0.2475	0.7525	121.4	230.3	143.9	-14.0	18.0	-27.0
East	2	0.0215	0.9785	55.6	134.0	263.6	-14.0	1.0	5.0
Gully	3	0.0123	0.9877	278.0	50.5	63.1	57.0	45.0	-7.0
Lower East	4	0.4500	0.5500	360.8	55.3	133.5	45.0	3.0	-4.0
Gold									
Main	1&5	0.3139	0.6861	153.1	101.4	146.4	-41.0	69.0	6.0
East	2	0.1500	0.8500	54.6	130.9	279.7	-11.0	2.0	2.0
Gully	3	0.1800	0.8200	264.4	44.5	106.7	23.0	28.0	-9.0
Lower East	4	0.1396	0.8604	350.0	88.0	201.7	46.0	33.0	-13.0

Table 17.3e Red Chris Model Interpolation Search Parameters by Zone

Red Chris Interpolation Search Parameters								
Zone	Code	Logic	Range Y	Range X	Range Z	Rot Z	Rot X	Rot Y
Mineralized Zone Indicator, 0.1% Cu								
Main	1	75% VG range	58.7	128.5	92.0	2.0	8.0	4.0
East	2&4		59.7	341.1	236.9	-18.0	-7.0	-24.0
Gully	NA		58.7	128.5	92.0	-18.0	-7.0	-24.0
Ore Zone Grades								
Pass 1								
Copper								
Main	1&5	100% VG range	121.4	230.3	143.9	-14.0	18.0	-27.0
East	2		55.6	134.0	263.6	-14.0	1.0	5.0
Gully	3		278.0	50.5	63.1	57.0	45.0	-7.0
Lower East	4		360.8	55.3	133.5	45.0	3.0	-4.0
Gold								
Main	1&5	100% VG range	153.1	101.4	146.4	-41.0	69.0	6.0
East	2		54.6	130.9	279.7	-11.0	2.0	2.0
Gully	3		264.4	44.5	106.7	23.0	28.0	-9.0
Lower East	4		350.0	88.0	201.7	46.0	33.0	-13.0
Pass 2								
Copper								
Main	1&5	67% VG range & 22m Vertical Search	81.3	154.3	96.4	-14.0	18.0	-27.0
East	2		37.3	89.8	176.6	-14.0	1.0	5.0
Gully	3		186.3	33.8	42.3	57.0	45.0	-7.0
Lower East	4		241.7	37.1	89.4	45.0	3.0	-4.0
Gold								
Main	1&5	67% VG range & 22m Vertical Search	102.6	67.9	98.1	-41.0	69.0	6.0
East	2		36.6	87.7	187.4	-11.0	2.0	2.0
Gully	3		177.1	29.8	71.5	23.0	28.0	-9.0
Lower East	4		234.5	59.0	135.1	46.0	33.0	-13.0
Waste Zone Grades								
Copper and Gold								
All Zones	1,2,3,4,5	Inverse distance squared with a spherical 200M range						
		Range of influence if grade > .2 limited to 40M						

In all cases the following rules were applied:	Pass 1	Pass 2
Maximum distance to nearest composite	130.0	60.0
Maximum composites used	9.0	9.0
Maximum Composites per drill hole	3.0	3.0
Minimum number of composites Pass 2	3.0	4.0
No interpolation across zone boundaries		
Indicator matching for all but indicator interpolation		
A code was placed in the model to limit the extrapolation of grades around drillholes to 100M along zone, 60M across zone, and 60M vertical		

17.3 Specific Gravity Modeling Calculations

Every insitu block in the model has a specific gravity assigned to it to enable a tonnage to be calculated. The data set collected from core samples comprised of a total of 3,039 composited SG measurements loaded into the composite drillhole file. The arithmetic average of all the composite samples was 2.78.

The SG modeling process began with the assignment of the average, 2.78, to every insitu block in the model. This was followed interpreting grades into the blocks with a single pass spherical inverse distance squared calculation utilizing the following parameters:

- Max search distance 250 m
- Min # of Measurements 2
- Max # of Measurements 30

The resulting SG's were verified visually by comparing the block model to the drill data. No significant discrepancies were noted. A comparison to the 2004 geologic model was also made utilizing the 0.2% Cu cut-off for the mineralized blocks within the proposed pit. The 2010 model mineralized blocks had an average SG of 2.80, the same as the 2004 model.

17.4 Model Validation

The modeling results were validated both visually and numerically. Using the 3D Viewer in the MineSight program, the grades and coding in the modeled blocks were manually compared to the drilling in cross section view (both North/South and East/West). This was also done in plan view for every model bench level. No significant discrepancies in grade or coding were noted between the block model and the drillhole assay composites. Figure 17.4 below shows (Section 451960E) the Main Zone Domain; with drillhole copper assays against interpolated block model copper grades. As show, the model grade interpolation to the south and north is limited by the zone wire frame solid.

Figure 17.4 Section 451960E; Cu Drillhole Assay Grades vs Interpolated Model Cu Grades

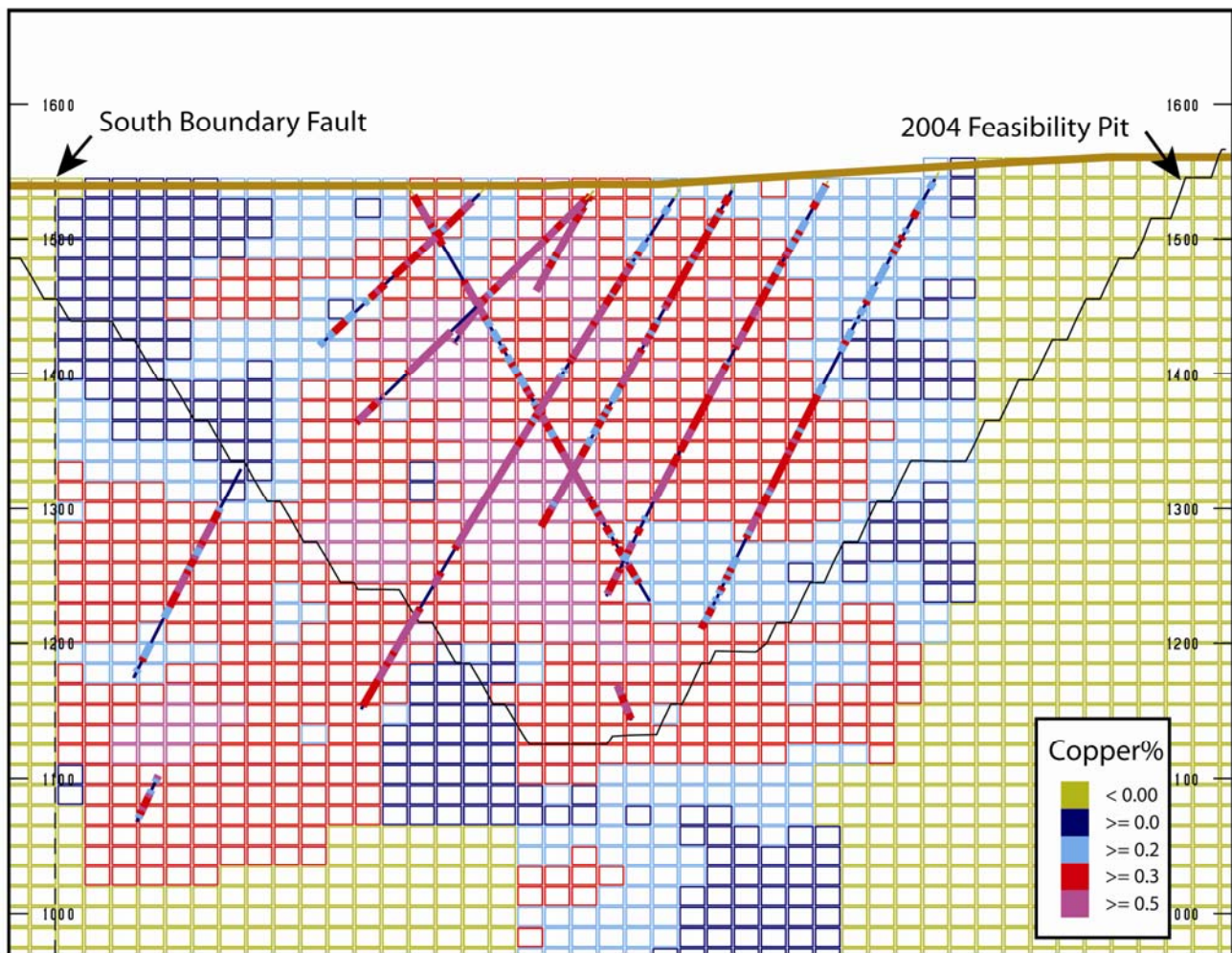

Looking West

18 Other Relevant data and Information

The previously published mineral reserve, mine plan, and the accompanying feasibility study have not been updated and therefore will only be referenced in this report.

The results of the 2004/2005 Red Chris Feasibility Study Report are based on

- conventional open pit mining
- a 30,000 tonne per day flotation mill
- shipment of concentrates going to Pacific rim smelters
- shipping from the B.C. port of Stewart
- estimated 25 year mine life.

The feasibility results include Proven and Probable Reserves, metallurgical performance, capital and operating cost estimates and financial analysis as performed and consolidated by AMEC E&C Services (“AMEC”), Vancouver, B.C. in the Red Chris Feasibility Study with contributions from various independent consultants as follows:

- Giroux Consultants: preparation of the resource estimate.
- Nilsson Mine Services Limited: preparation of Proven and Probable Reserve estimate, preparation of LOM mine plan, production schedule and mine capital and operating cost estimates.
- Merit Consultants International Inc.: estimation and consolidation of the project capital costs.
- G&T Metallurgical Services Limited: metallurgical test work.

Table 18 - Ore Reserve Summary for the 2004/2005 mine feasibility study

	Tonnes	Cu %	Au g/t	R-Cu	R-Au	R-CuEq	NMR
Proven	93,475,785	0.423	0.327	0.374	0.185	0.482	11.554
Probable	182,524,215	0.300	0.226	0.261	0.100	0.320	7.600
Total	276,000,000	0.349	0.266	0.299	0.129	0.374	8.939

Note: Metal assay values above labeled ‘R-‘ had a recovery equation applied to them and therefore are recovered metal values. (i.e. R-Cu = Recovered Copper)

The ore reserves were reported at a \$3.75/t net smelter return cutoff. The selection of this cutoff level was based upon a pit rim decision for recovery of processing and general & administration onsite operating costs. Low grade quantities were segregated in the production schedule. Material between \$3.25/t net smelter return and \$3.75/t was designated as low grade one (LG1) and separated for future processing if economic conditions improve beyond the levels assumed for this study. Material with a net smelter return value above \$3.75/t but less than the applied cutoff for a particular pit phase was designate low grade two (LG2). The LG2 material was scheduled to the East Stockpile area and reclaimed for processing in Year 17 through Year 25 (see figure 18.1 for mine development concept).

The full feasibility study and mine plan can be found on the Imperial website and on SEDAR.

On the Imperial website the report is available in two parts at this URL

<http://www.imperialmetals.com/s/RedChris.asp>.

On SEDAR the report is available under Company documents for bcMetals Corporation.

<http://www.sedar.com>

Figure 18.1 2004 Feasibility Study Mine Development Concept

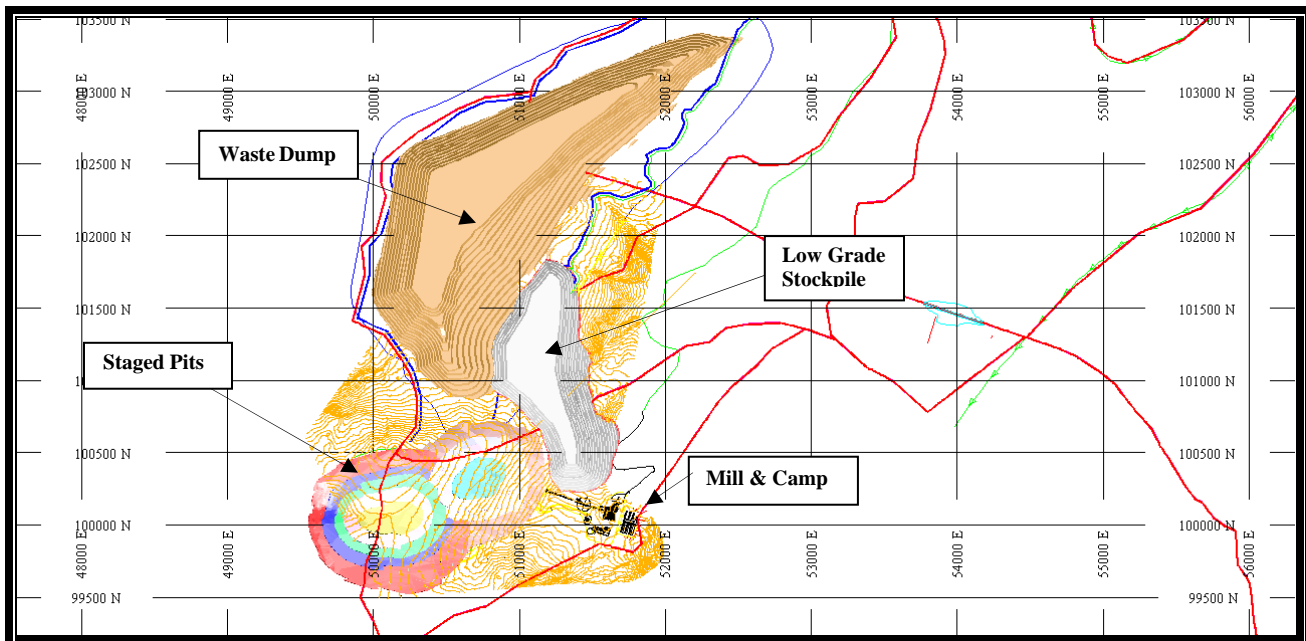

19 Interpretation and Conclusions

A review of the past exploration programs at the Red Chris Project shows a tremendous amount of high quality work has been completed including geologic mapping and sampling, geophysics, trenching, diamond drilling, modelling, preliminary mine planning, metallurgical studies, environmental base lines studies, and ABA testing.

The drilling, logging, and sampling protocols employed at the Red Chris Project in both the past and current drilling programs are appropriate for the deposit type and are being carried out in a fashion that meets or exceeds common industry standards. Assaying was carried out using industry standard methods and QA/QC protocols. The QA/QC data indicate that the assays are acceptable for use in Mineral Resource estimation.

The 2007 to 2009 drilling programs were highly successful in achieving their goal of increasing the size and depth of the deposit, especially in the East Zone. A total of 20 diamond drill holes were completed on the Main and East zones (holes numbered 07-335 to RC09-354). Of these holes 18 targeted the East Zone and saddle zone between the Main and East zones, and two holes in 2007 tested the deep extent of the Main Zone.

The 2007 to 2009 drill programs completed at Red Chris were also successful in increasing both the confidence in the estimated resource used in the 2004/2005 feasibility study and in increasing the total resource tonnage for the Red Chris deposit.

The new model includes all the 2007 to 2009 diamond drill holes, plus two from the 2010 program (22 in total). At a 0.3% copper cutoff the updated resource shows an increase in measured and indicated tonnage of 30%, with an increase in copper grade of 17% and gold grade of 50%. In the inferred category the updated model shows an increase in tonnage of 89%, with an increase of 24% in copper and 60% increase in gold. The large increase in inferred resources is due mainly to the new deep drilling added since 2007.

20 Recommendations

The highly successful deep drilling program should be continued in the East Zone and expanded in all directions, with an emphasis on connecting it to the Main Zone. New deep drilling should be able to not only increase the size of the deposit at depth but convert the large increase in tonnage in the Inferred category to the Measured and Indicated category.

The average space (drilling grid) used in the 2007 to 2009 drilling was about 50m. With the consistency in the deep mineralization seen to date this drill spacing could be increased to 200m, with infill spacing between 50m to 100m where warranted on the same grid. It is also recommended that the deep drilling should also be expanded to the Gulley Zone and surrounding area.

Geophysical work done in 2009 combined with geologic mapping indicates that there is significant potential for finding additional discrete zones of mineralization elsewhere on the property and although these targets are higher risk, they should be tested. The exploration of the deep East Zone has proven that the rewards for discovery can be very high, so stepping out with future exploration plans is recommended.

The marginal mineralization that has been identified in the Far West and Gulley zones is in itself not terribly attractive but the mineralization and associated alteration does indicate the presence of a very strong hydrothermal system. Those geologic observations combined with attractive geophysical signature strongly point to the deeper levels of these zones being the highest priority for the step out exploration program.

Further work on the mineralogy and metallurgy of the expanding resource at depth is also recommended. Preliminary work to date indicates that this mineralization will have a substantially better response to flotation recovery than the upper mineralization upon which the 2005 Feasibility Study was based.

In conclusion, continued deployment of a variety of exploration tools including geologic observation and interpretation, geophysical techniques and of course drilling should be the backbone of the planned exploration campaign contemplated as the project is advanced. The significant increase in the grade and volume of identified mineralization over the past three years is testament to the potential that may remain untapped on the property. Continued diligent and aggressive exploration is highly recommended.

21 References

Ash, C. H. and Fraser, T. M. (1994): 1994 Geological Mapping of the Tatogga Lake Project; An Ongoing Four-Year Geological Mapping Project for the B.C. Ministry of Energy, Mines and Petroleum Resources, Geological Survey Branch.

Ash, C. H., Fraser, T. M., Blanchflower, J. D. and Thurston, B. G. (1995): Tatogga Lake Project, Northwestern British Columbia (104H/11,12); in Geological Fieldwork 1994, B.C. Ministry of Energy, Mines and Petroleum Resources, Paper 1995-1, pages 343-358.

Ash, C. H., Stinson, P. K. and Macdonald, R. W. J. (1996): Geology of the Todagin Plateau and Kinaskan Lake Area, Northwestern British Columbia (104H/12, 104G/9); in Geological Fieldwork 1995, B.C. Ministry of Energy, Mines and Petroleum Resources, Paper 1996-1, pages 155-174.

Ash, C. H., Macdonald and Friedman, R.M. (1997a): Stratigraphy of the Tatogga lake area, northwestern British Columbia (104H/12,13, 104G/9,16); in Geological Fieldwork 1996, B.C. Ministry of Energy, Mines and Petroleum Resources, Paper 1997-1, pages 283-297.

Ash, C. H., Macdonald, R. W. J., Stinson, P. K., Fraser, T. M., Nelson, K. J., Arden, K. M. and Lefebure, D. V. (1997b): Geology and Mineral Occurrences of the Todagin Lake Map Area (104H/12NW & 13SW; 104G/9NE & 16SE); B.C. Ministry of Employment and Investment, Open File 1997-3, 1:50 000 map.

Baker, T., Ash, C.H. and Thompson, J.F.H. (1997): Geological setting and characteristics of the Red Chris porphyry copper-gold deposit, northwestern British Columbia; in Exploration and Mining Geology, Volume 6, No. 4, pp. 297-316.

Blanchflower, J. D. (1995): 1994 Exploration Report on the Red-Chris Property, Todagin Plateau Area, Liard Mining Division, British Columbia, Canada; Unpublished Report for American Bullion Minerals Ltd., 79 pages plus appendices, maps and sections.

Chaplin, R. E. (1971): Geophysical Assessment Report (Induced Polarization) on the Red Group, Ealue Lake Area, Liard Mining Division, British Columbia; B.C. Ministry of Energy, Mines and Petroleum Resources, Assessment Report 3202.

Evenchick, C.A. and Thorkelson, D.J. (2005): Geology of the Spatsizi River map area, north-central British Columbia; Geological Survey of Canada, Bulletin 577, 276 pp.

Forsythe, J. R. (1975): Report of Diamond Drilling, Percussion Drilling, Geophysical Surveys, Red-Chris Property, Ealue Lake Area, Liard Mining Division; B.C. Ministry of Energy, Mines and Petroleum Resources, Assessment Report 5741.

Forsythe, J. R. (1977a): Report of Geochemical and Geophysical Surveys, Red-Chris Property, Ealue Lake Area, Liard Mining Division; B.C. Ministry of Energy, Mines and Petroleum Resources, Assessment Report 6489.

Forsythe, J. R. (1977b): 1976 Summary Report Red-Chris Property; Unpublished Internal Report, Texasgulf Inc., 33 pages plus appendices, maps and sections.

Forsythe, J. R. and Peatfield, G. R. (1974): Report of Diamond Drilling, Percussion Drilling and Line cutting, Red-Chris Property, Ealue Lake Area, Liard Mining Division; B.C. Ministry of Energy, Mines and Petroleum Resources, Assessment Report 5297.

Fluor Daniel Wright Ltd., (May 1995): Red-Chris Project Scoping Study Project 2360; private report prepared for American Bullion Minerals Ltd.; 150 pages with appendices and maps.

Fluor Daniel Wright Ltd (April 1996): Red Chris Project Prefeasibility Study; Private report prepared for American Bullion Minerals Ltd.; 135 pages plus appendices.

Friedman, R. M. and Ash, C. H. (1997): U-Pb Age of Intrusions Related to Porphyry Cu-Au Mineralization in the Tatogga Lake Area, Northwestern British Columbia; in Geological Fieldwork 1996, Lefebure, D. V., McMillan, W. J. and McArthur, J. G., Editors, B.C. Ministry of Employment and Investment, Paper 1997-1, p. 291-297.

Giroux, G.H., R. Rodger, J.D. Blanchflower (2002) Report on the Red Chris Copper-Gold Project, private report prepared for American Reserve Energy Corporation., 90 pages.

Giroux, G.H. and J. Bellamy (2004): Update Report on Red-Chris Copper-Gold Project; Private report prepared for bcMetals, February 16, 2004.

Lakefield Research Limited (April 19, 1996): An Investigation of the Recovery of Copper and Gold from Red Chris Samples; Private report prepared for American Bullion Minerals Ltd.; 63 pages plus appendices.

Leitch, C. H. B. and Elliot, T. M. (1976): Geology and Mineralization, Red-Chris Property; unpublished internal report, Texasgulf Inc., 28 pages.

Logan, J.M., Drobe, J.R., McClelland, W.C. (2000): Geology of the Forrest Kerr-Mess Creek area, northwestern British Columbia (NTS 104B/10 & 104G/2 & 7W); B.C. Ministry of Energy, Mines and Petroleum Resources, Bulletin 104, 164 pp.

MINFILE Map 104H, Spatsizi River; Ministry of Energy, Mines and Petroleum Resources, Mineral Occurrence Map , Scale 1:250,000, Revised Jan. 1992, Updated July, 1992. Researched and Compiled by J. L. Gravel.

Newell, J. M. (1978): Report on Diamond Drilling on Chris 2 and 4 Mineral Claims, Ealue Lake Area, Liard Mining Division; B.C. Ministry of Energy, Mines and Petroleum Resources, Assessment Report 6872.

Newell, J. M. and Leitch, C. H. B. (1976): Report on Diamond Drilling, Red-Chris Property, Ealue Lake Area, Liard Mining Division; B.C. Ministry of Energy, Mines and Petroleum Resources, Assessment Report 6111.

Newell, J. M. and Peatfield, G. R. (1995), The Red-Chris Porphyry Copper-Gold Deposit; in Schroeter, T. G. (ed.) Porphyry Deposits of the Northwestern Cordillera of North America, Canadian Institute of Mining and Metallurgy Special Volume 46.

Peatfield, G. R. (1981): Report on Diamond Drilling on the Red 9 Mineral Claim (part of the Red-Chris Property), Liard Mining Division; B.C. Ministry of Energy, Mines and Petroleum Resources, Assessment Report 8994.

Read, P. B. (1984): Geology, Klastline River (104G/16E), Ealue Lake (104H/13W), Cake Hill (104I/4W) and Stikine Canyon (104J/1E); Geological Survey of Canada, Open File 1080, Scale 1:50,000.

Read, P. B. and Psutka, J. F. (1990): Geology of Ealue Lake East-Half (104H/13E) and Cullivan Creek (104H/14) Map Areas, British Columbia; Geological Survey of Canada, Open File 2241, Map with Notes, Scale 1:50,000.

22 Certificates of Authors

Stephen B. Robertson, P.Geol.
Imperial Metals Corporation
200-580 Hornby Street
Vancouver, BC, V6C 3B6

I, Stephen Robertson, hereby certify that:

- I am a geologist, employed by Imperial Metals Corporation.
- I am a 1989 graduate of the University of Alberta in Edmonton, with a Bachelor of Science degree in geology.
- I have been employed in mining since 1988 and have continuously practiced my profession since 1989.
- I am a Professional Geoscientist, registered with the Association of Professional Engineers and Geoscientists of the Province of British Columbia.
- I have been on site at the Red Chris property regularly since 2007, I supervised and planned the programs described in this report.
- This report is based on the information gained during the 2007 through 2009 field seasons and a review of private company and public reports. I have reviewed the reports content for completeness and accuracy.
- I have read the N.I. 43-101 document. As a result of my experience and qualifications, I am a Qualified Person as defined in N.I. 43-101.
- This report may be used for development of the property or raising of funds, provided that no portion of it is used out of context, or in such a manner as to convey a meaning different from that set out in the whole.

Signed at Vancouver, British Columbia, this 19th day of May, 2010.

Original is Dated, Signed and Sealed



Stephen Robertson, P.Geol.

Certificate of Author

Greg Gillstrom, P.Eng
Imperial Metals Corporation
200-580 Hornby Street
Vancouver, BC, V6C 3B6

I, Greg Gillstrom, hereby certify that:

- I am a registered Profession Engineer with the Association of Professional Engineers and Geoscientist of British Columbia.
- I graduated from the University of British Columbia with a Bachelor of Applied Science in Geological Engineering in 1990, and from the British Columbia Institute of Technology with a Diploma of Technology in Electrical Engineering in 1984.
- I have been practicing my profession continuously since graduating from UBC. I have been involved in numerous exploration and mining projects concerning base and precious metals. I have been employed by Imperial Metals as a Geological Engineer since 2004.
- I have been working on the Red Chris Project since 2007. I have been responsible for the ongoing compilation of Red Chris data and geological modeling of the Red Chris deposit. I was responsible for compilation and assembly of this report.
- I have read the N.I. 43-101 document and have attended several seminars on writing 43-101 compliant reports. As a result of my experience and qualifications, I am a Qualified Person as defined in N.I. 43-101.
- This report may be used for development of the property or raising of funds, provided that no portion of it is used out of context, or in such a manner as to convey a meaning different from that set out in the whole.

Signed at Vancouver, British Columbia, this 19th day of May, 2010.

Original is Dated, Signed and Sealed



Greg Gillstrom, P.Eng.

23 Appendix A - East Zone Metallurgical Report

*FINAL REPORT ON DEEP EAST ZONE
SCOPING STUDY*

*IMPERIAL METALS CORPORATION
RED CHRIS PROJECT*

KM2543

May 4, 2010

G&T METALLURGICAL SERVICES LTD.

2957 Bowers Place, Kamloops, B.C. Canada V1S 1W5

E-mail: info@gtmet.com , Website: www.gtmet.com

ISO 9001:2008
Certificate No. FS 63170



INDEX

	<u>PAGE</u>
1.0 Introduction	1
2.0 Ore Characteristics	3
2.1 Ore Hardness.....	3
2.2 Chemical and Mineral Content.....	4
2.3 Mineral Fragmentation.....	5
3.0 Rougher Flotation Test Results	9
4.0 Cleaner Flotation Response	11
5.0 Cycle Flotation Response	13
6.0 Gold Department	15
7.0 Dewatering Properties	17
8.0 Quality of the Concentrate	19
9.0 Conclusions and Recommendations	21



Tom Shouldice, P. Eng.
President



Aralia Pojhan, EIT
Project Metallurgist

May 4, 2010
KM2543

Report Distribution:
Brian Kynoch, Imperial Metals Corporation, Vancouver, BC – 1 Copy
Matt Bolu, Bolu Consulting, Vancouver, BC – 1 Copy
G&T Metallurgical Services Ltd., Kamloops, BC – 1 Copy

1.0 Introduction

The Red Chris deposit, owned by Imperial Metals Corp., is described as a porphyry deposit containing copper, gold, and silver. The deposit is located in northern British Columbia about 80 kilometers south of Dease Lake.

A proposal to complete a metallurgical test program on the Red Chris deposit was requested and supplied to Mr. Matt Bolu, a consultant to Imperial Metals Corp. The scope of this work included an assessment of the mineralogical and metallurgical response of a new mineralized zone, recently located during drilling at depth. The assessment was to be conducted with respect to the previously developed process for treating Red Chris mineralization*. The main objectives of the proposed test program can be outlined as follows:

- Prepare approximately 200 kilograms of the Red Chris material into two composites, designated High Gold Copper Ratio East Zone Composite and High Bornite East Zone Composite.
- Conduct a full suite of Bond comminution tests on each composite to determine its ore hardness properties. These included ball, rod, abrasion, and impact crushing determinations.
- Conduct a mineralogical analysis of the composites, at the suggested primary grind size of 150 μ m K₈₀. This analysis would provide a quantitative assessment of minerals contained in the feed and fragmentation characteristics of the key sulphides by particle size range. This data is critical in determining appropriate grind size for the flotation feed streams.
- Conduct flotation studies to investigate the effects of primary grind size, regrind size, pH, and various reagents. These tests would be conducted as rougher and batch cleaner tests. Conditions established in earlier programs will guide the selection of collectors and flotation pulp pH.

* A series of metallurgical programs were conducted here at G&T on both the East and Main Zones.

- Produce metallurgical performance estimates using locked cycle testing protocols. The best derived conditions from the batch cleaner tests would be used for the locked cycle tests.
- Assess the final tailings from a single test for gold recovery using the Knelson gravity concentration unit. Evaluate gravity concentrate, as well as the copper concentrate and pyrite concentrate, of that test for gold occurrences using an Automated Digital Imaging System (ADIS).
- Assess the pyrite rougher tailings of a single test for acid generation potential by performing an ABA test. The ABA data is summarized in Appendix IV.
- Assess the final concentrates for dewatering properties and minor elements.

About 859 kilograms of sample in the form of quarter drill core were received for this study. From this material inventory, the two composites were constructed for use in this program, using 135 kilograms of the drill core inventory. The program commenced in mid January, 2010, and was completed by mid April, 2010. Following the test work, preparation of this technical report commenced.

The following technical brief summarizes the key technical points of the program. All of the test data generated through the execution of this program can be reviewed in a series of appendices attached to this brief. The appendices are arranged as follows:

Appendix I – Sample Origin

Appendix II – Flotation Test Data

Appendix III – Particle Sizing Data

Appendix IV – Special Assay & ABA Data

Appendix V – Modal Analysis Data

Appendix VI – ADIS Analysis Data

2.0 Ore Characteristics

There are several inherent characteristics of an ore that will predispose the process design required to extract and concentrate minerals of value. Ore hardness defines the power needed during the comminution process. The mineral and chemical content dictate the configuration of the flotation process. The mineral fragmentation characteristics determine the comminution requirements to permit a physical separation of the valuable minerals. These important parameters, that impact on process design, are discussed further in the following subsections.

2.1 Ore Hardness

Ore hardness was measured using a standard Bond ball and rod mill work index test. The abrasiveness of the samples was also measured by a Bond abrasion test. A standard Bond ball mill work index test procedure with a closing sieve aperture size of 106 μ m was used. The results of these tests are summarized in Table 1.

TABLE 1
BOND WORK INDEX

Sample	Ball Work Index kWh/tonne	Rod Work Index kWh/tonne	Abrasion (g)
High Gold Copper East Zone	14.6	10.5	0.4517
Bornite East Zone	16.7	16.0	0.3147

Note: a) All tests performed to Bond standards.
b) See Appendix III for additional test data.

The results of the tests indicated that the Bornite East zone was moderately hard compared to the High Gold Copper Ratio East Zone Composite*. Conversely, the High Gold Copper East Zone Composite was more abrasive than the High Bornite East Zone Composite.

* The previously studied East Zone samples (KM1428) had an average work index of 14.3 kWh/tonne.

2.2 Chemical and Mineral Content

The chemical and mineral contents of the composites were determined using standard analytical techniques and QEMSCAN particle mineral analysis (PMA). The results of QEMSCAN analysis provided quantitative mineral content values for the array of sulphide minerals observed in the sample. The relevant data summary is presented in Table 2.

TABLE 2
CHEMICAL AND MINERAL CONTENTS

Element or Mineral	Symbol	Units	High Gold Copper East Zone	Bornite East Zone	KM1428 East Zone Global
<u>Element</u>					
Copper	Cu	%	2.9	1.4	0.74
Iron	Fe	%	5.9	4.6	7.1
Sulphur	S	%	3.7	0.85	-
Silver	Ag	g/t	6.0	6.4	-
Gold	Au	g/t	4.74	1.84	0.69
Weak Acid Soluble Copper	Cu Ox	%	0.022	0.024	-
Cyanide Soluble Copper	CuCN	g/t	0.073	0.94	-
<u>Mineral</u>					
Chalcopyrite	Cp	%	8.5	0.6	1.4
Bornite	Bn	%	<0.1	2.0	0.4
Chalcocite/Covellite	Ch/Cv	%	0.1	<0.1	<0.1
Pyrite	Py	%	2.6	0.2	5.9
Ankerite	Ank	%	7.5	16	-
Quartz	Qz	%	61	40	-
Micas	Mic	%	10	21	-
Other Gangue	Gn	%	10.4	20.4	92.4

Notes: a) Detailed head assay and mineralogical content data are located in Appendix IV and V.
b) Detailed copper distribution for the NOX Composite can be located in Appendix IV.

Both samples contained relatively high values of copper and gold compared to previously studied East Zone samples, as shown in Table 2.

The new composite samples also display relatively low levels of pyrite compared to the amount of copper sulphides. The samples also contained ankerite and other carbonate minerals. These minerals were present in the previous samples and can provide neutralization potential for the tailings.

2.3 Mineral Fragmentation

The mineral fragmentation characteristics of the two sulphide composites* were measured using QEMSCAN PMA at a nominal grind sizing of 150µm K₈₀. The data, along with data from a previous test program are displayed in Table 3.

TABLE 3
MINERAL LIBERATION CHARACTERISTICS – TWO DIMENSIONS

Mineral Status	High Gold Copper East Zone				Bornite East Zone				East Zone Global-KM1428			
	Cp	Bn	Py	Gn	Cp	Bn	Py	Gn	Cp	Bn	Py	Gn
Liberated	66	14	40	95	29	50	25	98	47	41	40	85
Binary – Cp		76	24	4		14	12	1		1	2	4
Binary – Bn	3		4	<1	17		1	1	2		<1	2
Binary – Py	2	<1		1	1	<1		<1	2	<1		8
Binary - Gn	29	2	30		40	32	58		42	46	49	
Multiphase	1	8	6	<1	13	4	4	<1	7	2	9	1

Notes: a) Cs-copper sulphides, Cp-cuprite, Py-pyrite, and Gn-non-sulphide gangue.
b) Additional mineralogical data can be located in Appendix V.

Copper sulphides in both of the high grade samples were well liberated. The main form of interlocking occurred with non-sulphide gangue minerals at about 33 percent of the total copper sulphide minerals. These interlocked particles contained, on average, almost half copper sulphides by weight. The favorable fragmentation characteristics at this grind size should result in high recoveries of copper sulphides to the rougher concentrate.

Compared to the previously measured East Zone Global Composite, the new samples display a much higher degree of mineral liberation for the same grind size.

* The mineral fragmentation characteristics for the North Oxide Zone were not determined as very little of the copper was in sulphide form.

QEMSCAN IMAGE 1
RED CHRIS, HIGH BORNITE EAST ZONE

Examples of Liberated Chalcopyrite and Bornite



Examples of Copper Sulphide Binaries with Gangue

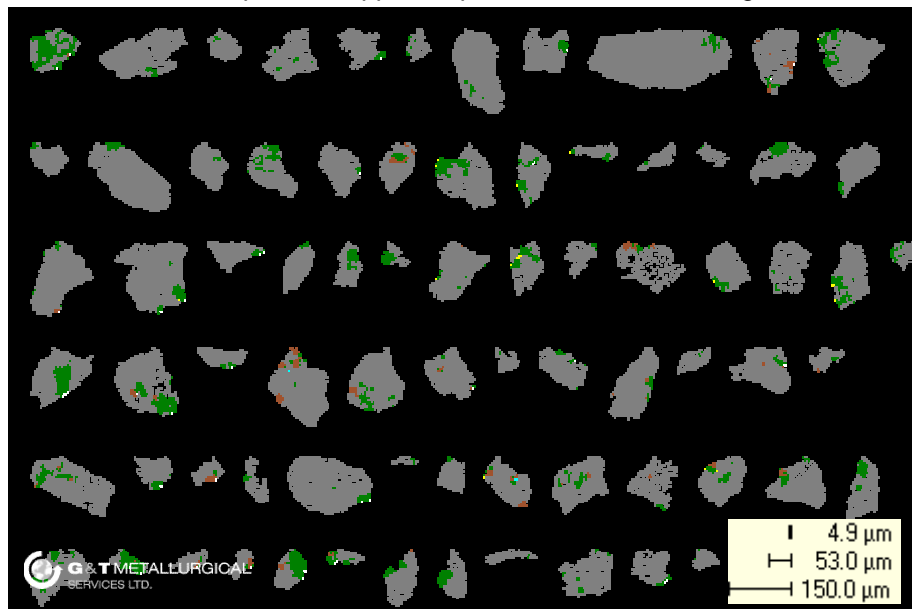

 Chalcopyrite	 Chalcocite	 Gangue
 Bornite	 Pyrite	

2.3 Mineral Fragmentation - continued

The mineral liberation data can be manipulated to estimate the effect of primary grind sizing on mineral liberation. These analyses, performed on the two deep east zone composites, are displayed in Figure 1. Liberation values at two grind sizes were extrapolated using the measured data at 150 μm K₈₀.

The primary grind size, however, had little effect on the liberation of the copper sulphide minerals. Therefore, large changes in primary grind size would be required to elicit a change in mineral liberation and subsequent flotation response.

Typically, for simple copper porphyry ores, two dimensional copper sulphide liberations of approximately 50 percent are required to ensure the recovery of most of the copper sulphides into the rougher concentrates. Based on this relationship, a primary grind sizing of about 250 μm K₈₀ could be used to treat both composites.

The mineral fragmentation data for the target minerals was also used to calculate a theoretical mineralogically limiting grade-recovery curve as shown in Figure 1B.

This curve displays the maximum grade-recovery for copper sulphide minerals at a nominal primary grind sizing of 150 μm K₈₀. The operating grade-recovery point generated from a typical operating plant is often offset to a position just below this mineralogically limiting curve. A small amount of rougher concentrate regrinding would be required to efficiently recover high grade final copper concentrates. Undoubtedly, the current target of 25 μm K₈₀ would be too fine for this mineralization.

FIGURE 1A
EFFECT OF PRIMARY GRIND SIZE ON MINERAL LIBERATION

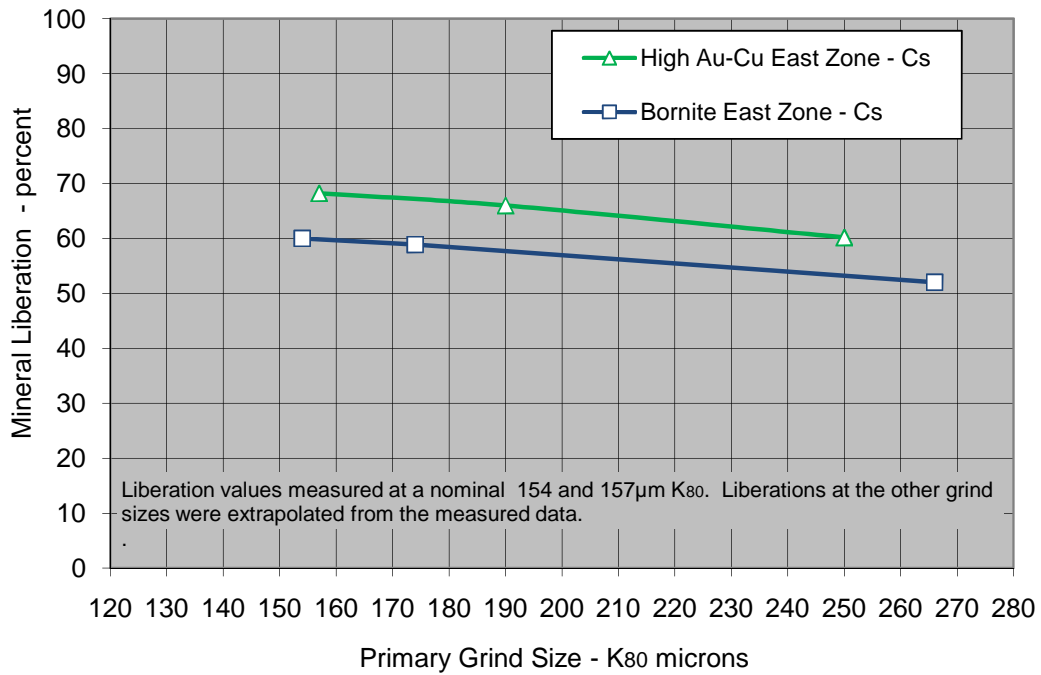
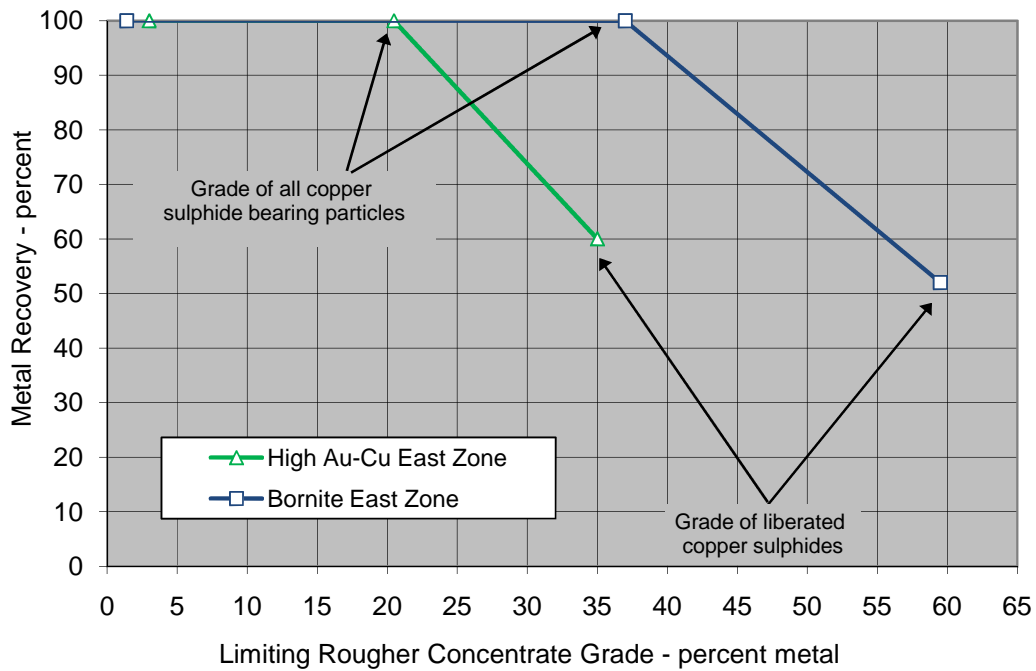

FIGURE 1B
MINERALOGICALLY LIMITING GRADE RECOVERY CHART
Feed Ground to Nominal 150µm K80



Note: Additional mineralogical data can be located in Appendix V.

3.0 Rougher Flotation Test Results

A total of six rougher flotation tests were performed in this program, using the schematic flowsheet shown in Figure 2. Additional rougher flotation stages were added to the flotation test to ensure recovery of all sulphides in each composite. The collector was added by stage to first recover copper sulphides, and then more aggressive dosages were added to recover any pyrite* in the sample. The graphs shown in Figure 2 display the results of the relevant flotation tests.

The High Gold Copper East Zone Composite exhibited almost perfect copper metallurgical performance**. Copper recoveries of 97 to 98 percent were achieved with a rougher mass recovery of about 20 percent. Similarly, gold was also well recovered to the rougher concentrate. On average, between 91 and 93 percent of the gold in the feed was recovered into a rougher concentrate containing 20 percent of the feed mass. Both copper and gold rougher flotation performances were well above average for deposits of this type. Clearly this composite could be processed at a much coarser feed sizing.

The High Bornite East Zone Composite also performed well. Copper in the feed was 93 to 95 percent recovered into the rougher concentrate at a rougher mass recovery of about 10 percent. Gold recoveries to the rougher concentrate were lower; averaging about 88 percent at 10 percent feed mass recovery.

None of the variables tested dramatically affected metallurgical response of the two composites. Using collector dosages of PAX (potassium amyl xanthate) between 3 to 8 g/tonne and at natural pH will provide the most cost effective means of recovering copper and gold into a rougher concentrate.

The observed performance was superior to results achieved on previously tested East Zone samples. The high grade of copper and gold, low pyrite content and favorable fragmentation properties of the composites make these composites respond well at the previously developed Red Chris process conditions.

* There was very little pyrite in the Bornite East Zone sample.

** A comparison to previously tested samples is displayed in Appendix IV, Figure IV-1.

FIGURE 2

ROUGHER CIRCUIT METALLURGICAL PERFORMANCE DATA

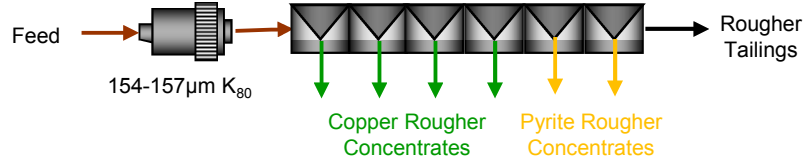

Nominal Rougher Test Conditions

Stage	pH	Reagents - g/tonne	
		PAX	MIBC
Primary Grind	8.0-9.5	-	-
Cu Rougher	7.8-10.7	3-96	38-270
Py Rougher	7.3-10.3	40	0-60

ROUGHER PERFORMANCE- High Au-Cu East Zone

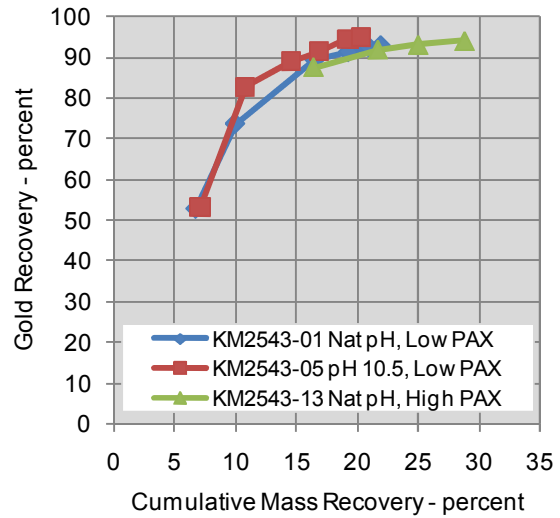
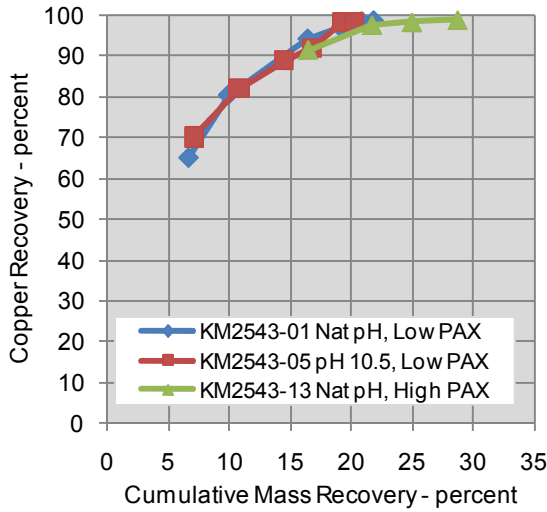

ROUGHER PERFORMANCE – Bornite East Zone

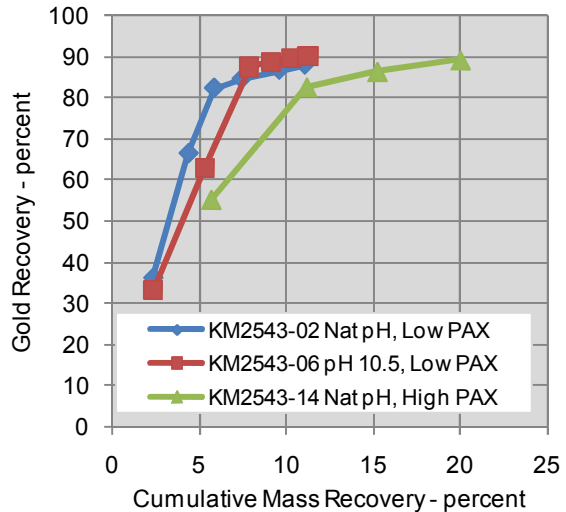
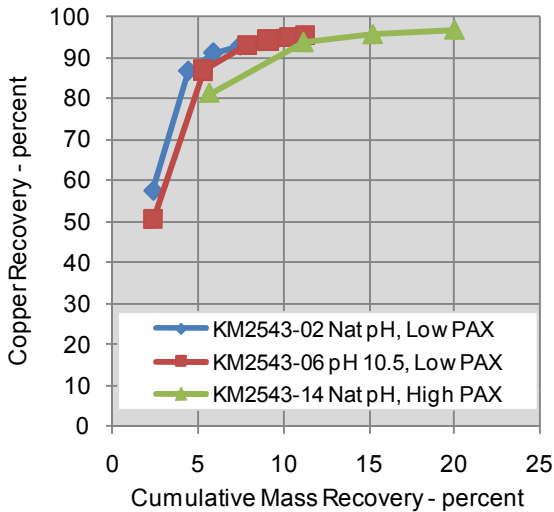

4.0 Cleaner Flotation Response

A total of six open circuit batch cleaner tests were performed on both composites in order to assess the concentrate production potential. All tests were conducted with elevated pH levels in the cleaner circuit. The flowsheet schematic used in these tests, along with a summary of test conditions and a graphical representation of the results obtained are displayed in Figure 3. The metallurgical performance is displayed as a series of grade recovery curves for both copper and gold. Gold was recovered into the copper concentrate as a byproduct.

For the High Gold Copper Ratio East Zone Composite, the best performance was achieved in Test 11. In this test, additional collector (3418A) was added along with Potassium Amyl Xanthate. The superior performance of this test would suggest that the previous tests may have had insufficient collector dosages. Overall the results were spectacular, copper was 96 percent recovered into a concentrate grading about 33 percent copper. Similarly, gold was 88 percent recovered into the copper concentrate. The gold grade in the concentrate was about 50 g/tonne.

The results for the High Bornite East Zone were more consistent. On average, about 90 percent of the copper in the feed was recovered into a concentrate grading about 45 percent copper. Gold performance was more variable, but on average, about 75 percent of the gold was recovered into the copper concentrate. The gold grade was about 60 g/tonne in the concentrate*.

Overall, the batch test performance for these high grade composites was very good using the previously developed flowsheet. This flowsheet, designed for low grade ores with considerably more pyrite in the feed, could likely be optimized to reduce operating costs. Adopting coarser primary and regrinding sizes, combined with lower pulp pH should be investigated.

* More optimization testing could also improve performance of these samples.

FIGURE 3

CLEANER TEST METALLURGICAL PERFORMANCE DATA

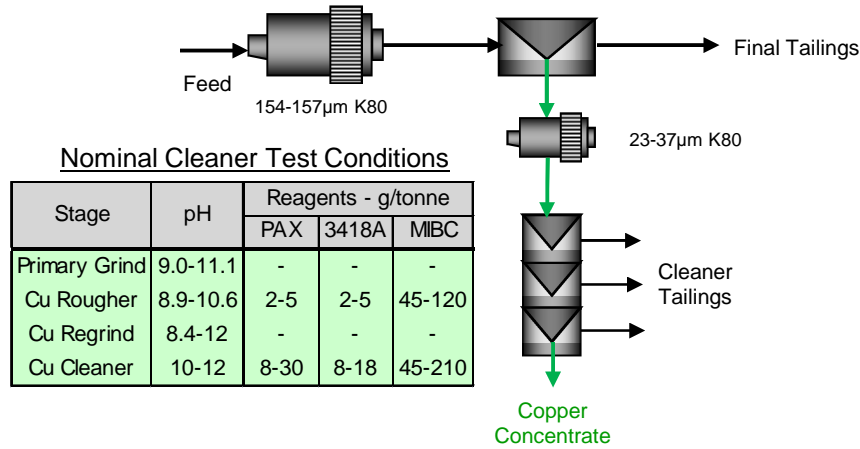

Cleaner Performance – High Cu-Au East Zone

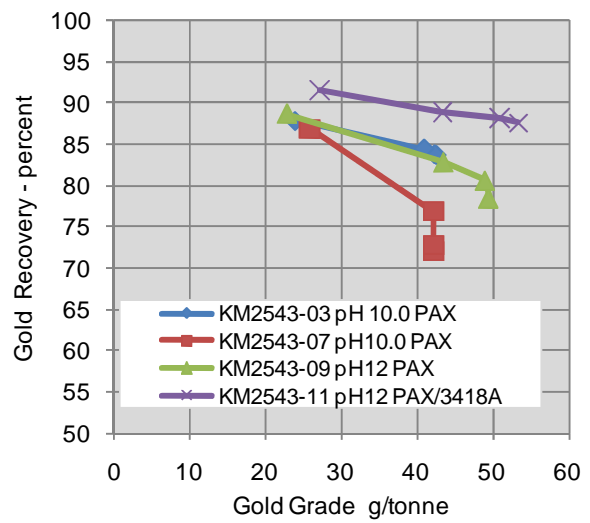
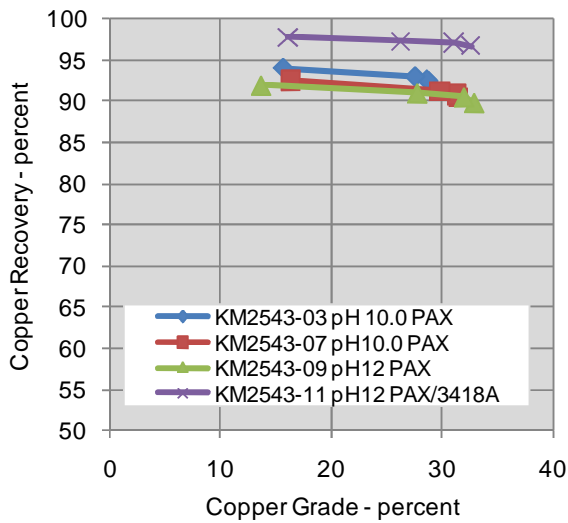

Cleaner Performance – Bornite East Zone

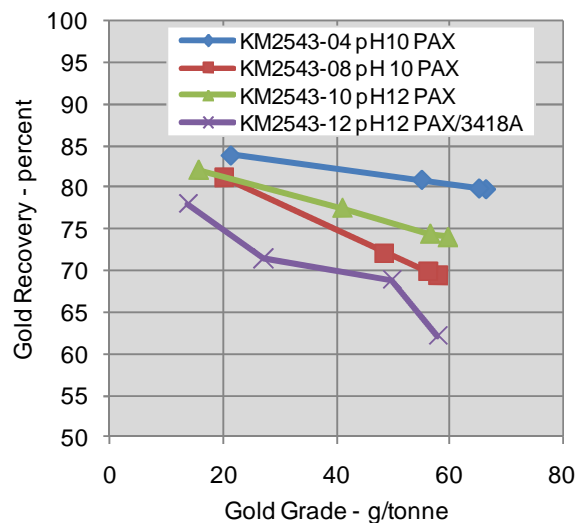
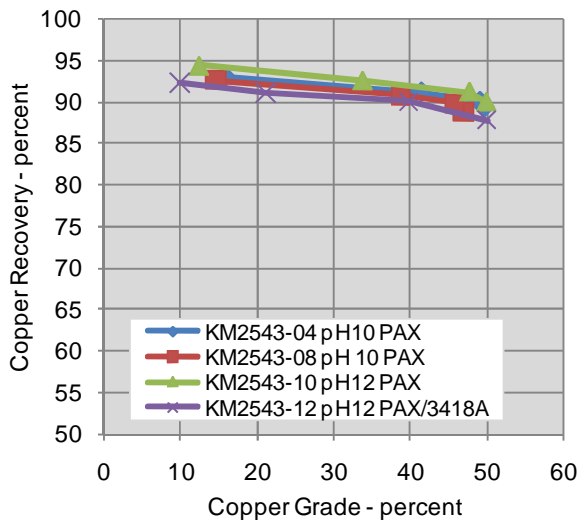

5.0 Cycle Test Flotation Response

Estimates of metallurgical performance, anticipated from a continuous operation, were determined by performing a locked cycle test on each of the two composites. The flowsheet schematic shown in Figure 4 was instituted for the two locked cycle tests, using the optimum rougher and batch cleaner test conditions. Also displayed in Figure 4 is a summary of the test conditions used, along with the locked cycle test results.

A basic reagent scheme was utilized for these tests, including Potassium Amyl Xanthate (PAX) as the collecting agent. Tests were conducted at a primary grind sizing of approximately 155 μm K₈₀ with a nominal regrind size of 25 μm K₈₀.

Both composites performed exceptionally well. Copper from the High Gold Copper Ratio Composite was 98 percent recovered from the feed, into a final concentrate grading 29 percent copper. Gold recovery to the final concentrate was also high at 90 percent, grading 47 g/tonne of gold.

Copper from the High Bornite East Zone Composite was 93 percent recovered into a final concentrate, grading 49 percent copper. Gold in this composite was 85 percent recovered into a final concentrate, grading 69 g/tonne of gold.

The first cleaner tailings from locked cycle test 17 were evaluated for gold recovery using a Knelson gravity concentrator, followed by hand panning techniques. Gold from the first cleaner tailings was 35 percent recovered into the pan concentrate, grading 57 g/tonne gold. This accounts for approximately, 1.5 percent of the total gold in the feed.

FIGURE 4
CYCLE TEST FLOWSHEET AND PERFORMANCE DATA

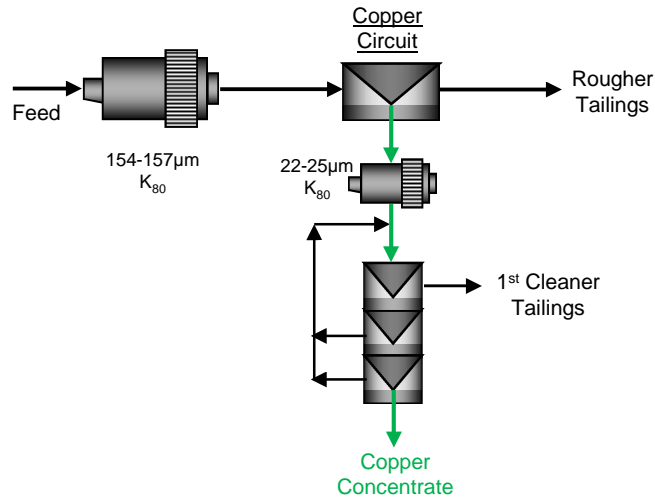

Nominal Cycle Test Conditions

Stage	pH	Reagents - g/tonne	
		Lime	PAX
Primary Grind	10.0	500	-
Roughers	10.5	250+	2
Scavengers	10.5	√	40
Regrind	12	1000	-
Cleaners	12	500+	30

Locked Cycle Test Results

Composite	Product	Mass	Assay - percent or g/tonne					Distribution - percent				
		%	Cu	Fe	S	Ag	Au	Cu	Fe	S	Ag	Au
Test 17 High Au-Cu Ratio East Zone	Flotation Feed	100	3.0	6.4	3.9	6	5.3	100	100	100	100	100
	Copper Con	10	28.5	30.7	33.4	50	46.7	98	49	88	86	90
	Copper 1st Clnr Tail	12	0.1	8.7	3.1	3	1.3	0	16	10	6	3
	Copper Ro Tail	78	0.1	2.9	0.1	1	0.5	2	35	2	8	7
Test 18 High Bornite East Zone	Flotation Feed	100	1.4	4.7	0.8	7	2.2	100	100	100	100	100
	Copper Con	3	48.8	17.1	25.4	207	68.7	93	10	85	80	85
	Copper 1st Clnr Tail	8	0.3	4.1	0.3	3	1.0	2	7	3	4	4
	Copper Ro Tail	89	0.1	4.4	0.1	1	0.3	5	83	11	16	11

Notes: a) Silver and gold are reported in g/tonne
b) Additional test data can be located in Appendix II.

6.0 Gold Deportment

In an effort to recover more gold from the rougher tailings, gravity concentration tests were conducted. The gravity concentration was a two step process; a Knelson concentrator was first used to recover gold, the Knelson concentrate was further upgraded using a hand panning technique. A schematic of the flowsheet and overall metallurgical summary for gold are displayed in Figure 5.

As shown in the table, most of the gold was recovered in copper flotation. An additional 3.5 and 5.8 percent gold was recovered from the feed into a “pyrite” concentrate. In fact, the relatively low pyrite content of the feed did not result in the flotation recovery of pyrite concentrates. The concentrate contained low levels of sulphur and should be considered copper scavenger concentrates.

The application of gravity to flotation tailings failed to yield a meaningful gold bearing concentrate. The incremental gold recovery was less than 0.5 percent for both composites. To better understand gold deportment in these streams, gold searches by an Automated Digital Imaging System (ADIS) were performed on exit streams of the combined flotation-gravity concentration test.

A summary of the data is displayed as pie charts on the bottom of Figure 5. Most of the gold occurrences were located in the copper concentrate, which contained about 90 percent of the gold in the sample. However, some occurrences were located in the pyrite and gravity concentrate. There was one occurrence located in the gravity tails, it was a small inclusion in non-sulphide gangue and not recoverable by flotation.

Using the ADIS data, a gold distribution in the feed was calculated. For these composites, 92 percent of the gold was either liberated or associated with copper sulphides; therefore recovery to the concentrate was expected. About 8 percent of the gold was observed as tiny inclusions in non-sulphide gangue. Further recovery by flotation or even leaching would be unlikely. Extraordinary fine grind sizes would be required to further enhance gold recovery of this stream.

FIGURE 5
GRAVITY FLOWSHEET AND METALLURGICAL PERFORMANCE DATA

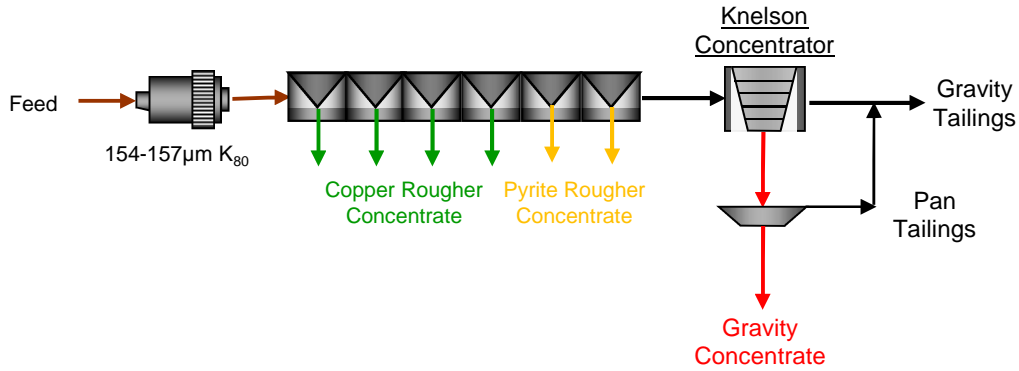

GRAVITY CIRCUIT GOLD METALLURGICAL PERFORMANCE DATA

Product	Mass percent	Assay - percent or g/t					Distribution - percent				
		Cu	Fe	S	Ag	Au	Cu	Fe	S	Ag	Au
KM2543 - 1,15											
Cu Rougher Con	16.4	17.1	22.4	22.4	32	30.3	94.1	57.2	93.8	84.4	89.6
Py Rougher Con	5.4	2.5	7.8	3.4	6	3.6	4.5	6.5	4.7	5.4	3.5
Gravity Conc	0.5	-	-	-	3	2.12	1.5	36.4	1.6	0.2	0.2
Gravity Tail	77.6	-	-	-	1	0.48	-	-	-	10.0	6.7
Feed	100	2.99	6.4	3.92	6.2	5.56	100	100	100	100	100
KM2543 - 2,16											
Cu Rougher Con	5.8	22.1	11.6	12.1	99	37.2	90.9	12.9	85.3	83.4	84.5
Py Rougher Con	5.2	1.1	4.4	0.9	7	2.9	4.2	4.4	5.5	5.0	5.8
Gravity Conc	0.6	-	-	-	2	1.6	-	-	-	0.2	0.4
Gravity Tail	88.3	-	-	-	1	0.27	-	-	-	11.5	9.3
Feed	100	1.42	5.2	0.83	6.9	2.57	100	100	100	100	100

Note: a) Gold Distribution is shown as recovery from the feed.

GOLD OCCURENCE DISTRIBUTION IN THE FEED

Calculated from ADIS Analysis of Test Products

High Au-Cu East Zone Composite

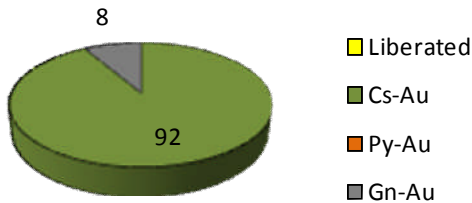

Bornite East Zone Composite

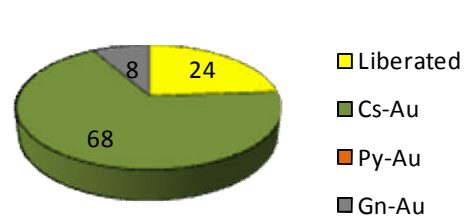

Note: a) Gold Distribution is based on ADIS of the Flotation and gravity test products.
 b) Detailed test data can be located in Appendix II.
 c) Multiphase particle were classified based on the primary mineral association.

7.0 Dewatering Properties

The settling properties of the copper concentrates produced from the two locked cycle tests were measured using simple graduated cylinder settling tests. With the settling test data, thickener area calculations were performed with the Talmadge Fitch method. A single flocculent was tested; Superfloc A130 at various addition rates, this data is presented in Figure 6. Details of the settling tests are located in Appendix IV.

Based on the settling rates, at a flocculate dosage of 2 g/tonne provided reasonable settling performance for both composites. The High Bornite East Zone had significantly better settling properties when compared to the High Gold Copper Ratio East Zone Composite. Due to limited sample, optimization was not complete. Future test programs should include allowances for more detailed studies.

Simple leaf filter tests were conducted to estimate vacuum filter properties of the copper concentrates. The test data is shown in Figure 6B. As shown, standard vacuum moistures for the copper concentrates from the High Gold Copper Ratio East Zone would be about 21 percent after about 2 minutes of drying time.* For the High Bornite East Zone, moisture content would be approximately 18 percent after about 2 minutes of drying time.

* Details of this test are located in Appendix IV.

FIGURE 6A
SUMMARY OF THICKENER TEST DATA
EFFECT OF FLOCCULANT ON THICKENER AREA CALCULATIONS

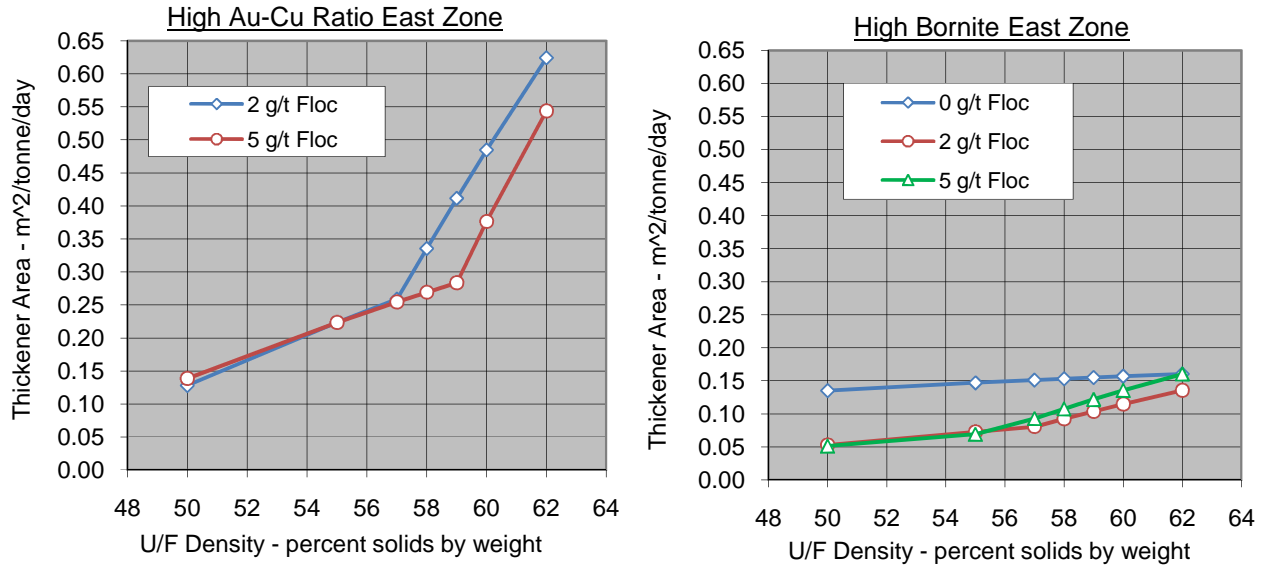

Notes a) The thickener areas are based on simple graduated cylinder tests using the Talmage-Fitch method to calculate the area.
 b) All of the settling test data is located in Appendix IV.

FIGURE 6B
SUMMARY OF VACUUM FILTERING TEST DATA
Copper Concentrate

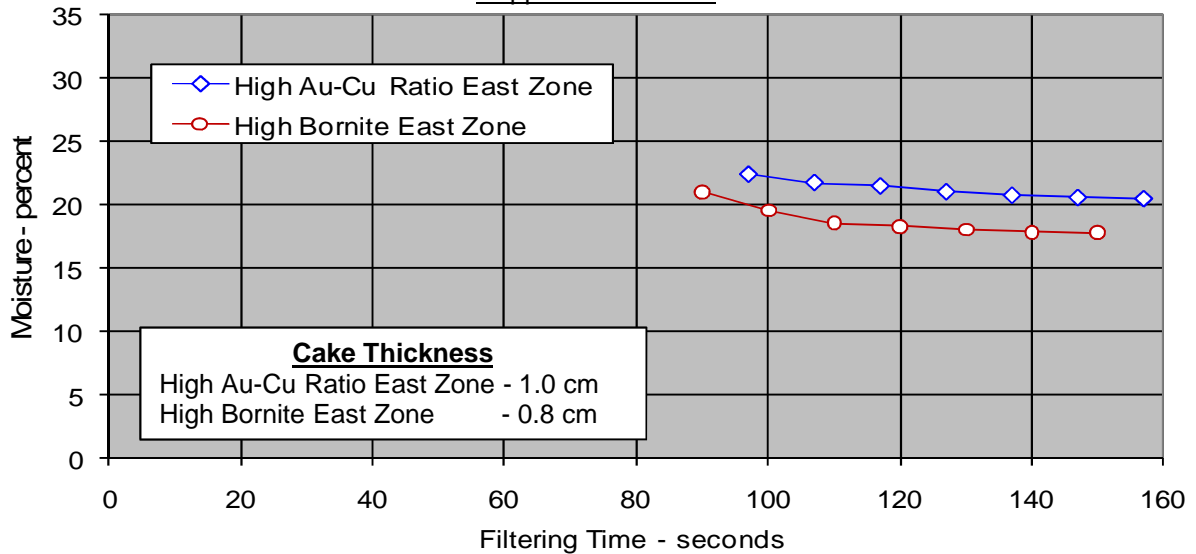

8.0 Quality of Concentrate

Minor element determinations were carried out on the final concentrate produced in locked cycle testing. Weighted composites of the final concentrate from cycles IV and V were assayed using standard metallurgical quality assay techniques, for a suite of elements that typically may attract smelter penalties. The minor assay data for the two composites tested in this program are displayed in Table 4.

In general, the final concentrates produced in these tests did not contain minor element concentration that would normally attract penalties at smelting. There are, however, a few minor elements that are present at concentrations that may attract smelter penalties. Elements worth noting in this respect are antimony, bismuth, and selenium.

The concentrates produced contain significant precious metal content with gold grades between 46 to 71 g/tonne, and silver grades between 152 to 323 g/tonne.

We recommend that the minor element data be reviewed by an experienced marketing specialist to confirm any marketing issues for these concentrates. Individual smelters may impose penalties at variable concentrations and concentrate marketing specialists can provide more informed input on this subject.

TABLE 4
MINOR ELEMENT ASSAYS
Copper Concentrate IV + V

Element	Symbol	Unit	Test 17 High Au:Cu Ratio East Zone	Test 18 High Bornite East Zone
Aluminum	Al	%	0.25	0.51
Antimony	Sb	g/t	56	528
Arsenic	As	g/t	176	154
Bismuth	Bi	g/t	118	87
Cadmium	Cd	g/t	6	4
Calcium	Ca	%	0.24	0.52
Cobalt	Co	g/t	72	28
Copper	Cu	%	28.4	49.0
Fluorine	F	g/t	48	44
Gold	Au	g/t	46.1	71.1
Iron	Fe	%	30.3	16.4
Lead	Pb	%	0.02	0.02
Magnesium	Mg	%	0.16	0.20
Mercury	Hg	g/t	1.2	1.1
Manganese	Mn	%	0.004	0.007
Molybdenum	Mo	%	0.037	0.004
Nickel	Ni	g/t	94	78
Phosphorus	P	g/t	33	36
Selenium	Se	g/t	152	323
Silicon	Si	%	1.5	2.0
Silver	Ag	g/t	41	226
Sulphur	S	%	31.8	25.3
Zinc	Zn	%	0.02	0.02

9.0 Conclusions and Recommendations

Two composites originating from the Red Chris deposit East Zone were tested in this program of study. The samples represented deep mineralization which has recently been discovered. When tested for ore hardness, it was determined that the High Bornite East Zone sample was moderately hard compared to the High Gold Copper Ratio East Zone sample. The High Bornite East Zone and High Gold Copper Ratio East Zone samples had an ore hardness of 16.7 and 14.6 kWh/tonne and a rod work index of 16.0 and 10.5 kWh/tonne respectively. The abrasion index of the two composites was determined to be 0.31 and 0.45 g respectively.

The two composites contained between 1.4 and 2.9 percent copper. This value was significantly higher than that of the East Zone samples tested in a previous Red Chris program conducted at G&T Metallurgical Services Ltd. The majority of the copper in the High Gold Copper Ratio East Zone sample was in the form of chalcopyrite while bornite, as expected, was the main form of copper sulphide mineral in the High Bornite East Zone sample. Pyrite values in these two samples were extremely low and considerably lower than the previously tested East Zone material.

The fragmentation characteristics for the sulphide minerals were measured at a primary grind size of 150 μ m K₈₀. At this grind size, copper sulphides in both composites were well liberated. About 33 percent of the copper sulphides for both composites were interlocked with non-sulphide gangue minerals. These particles, however, contained sufficient copper to ensure their flotation into the rougher concentrate.

The composites were evaluated with a process flowsheet developed for lower grade East Zone material containing more pyrite. A primary grind size of 150 μ m K₈₀ and a target regrind size of 25 μ m K₈₀, was used for both composites. Both composites performed remarkably well and there is considerable potential to

reduce the operating cost of the process. Notably, both the primary grind and regrind sizes could be increased with this high grade mineralization with only a small decrease in metallurgical performance. Similarly, pH levels and subsequent lime consumption could likely be reduced due to the low pyrite content of the sample.

In locked cycle testing, copper recovery to the final concentrate, from the High Gold Copper Ratio East Zone sample was 98 percent, with a copper concentrate grade of 29 percent. Gold recovery to the final concentrate was 90 percent, grading 47 g/tonne gold. Copper from the High Bornite East Zone sample was 93 percent recovered into a final concentrate, grading 49 percent copper. Gold was 85 percent recovered into the final concentrate, grading at a high 69 g/tonne gold.

In an attempt to increase gold recovery, gravity concentration tests were conducted on the rougher tailings of two select tests. Overall, only between 0.2 and 0.4 percent of the gold was recovered from the feed into the gravity concentrate. A gravity concentration, performed on the first cleaner tailings of a single locked cycle test also resulted in low gold recovery. Only about 1.5 percent of the feed gold was recovered into the gravity concentrate.

Minor element scans on the locked cycle test bulk concentrates showed elevated levels of antimony, bismuth, and selenium. These elements may attract smelter penalties and would require further consideration. High gold and silver content, in the cons, will contribute significantly to the metal revenues for this project.

The dewatering properties were measured for concentrates from each deep east zone composite. A limited number of settling and filtering tests were complete using very simple test procedures. The test indicated no significant dewatering concerns; however, there is considerable potential to further optimize dewatering performance if coarser regrind sizes are adopted. No further dewatering studies should be performed until the process flowsheet is fully optimized and significant concentrate is available.

PHOTOMICROGRAPH 1
RED CHRIS – COPPER ROUGHER CONCENTRATE
Test 01 KM2543

Particle 1

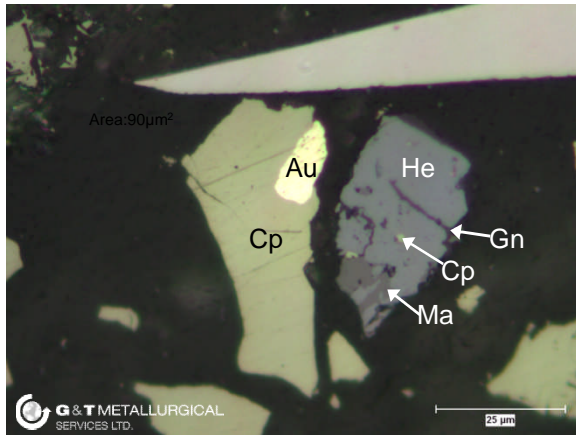

Particle 2

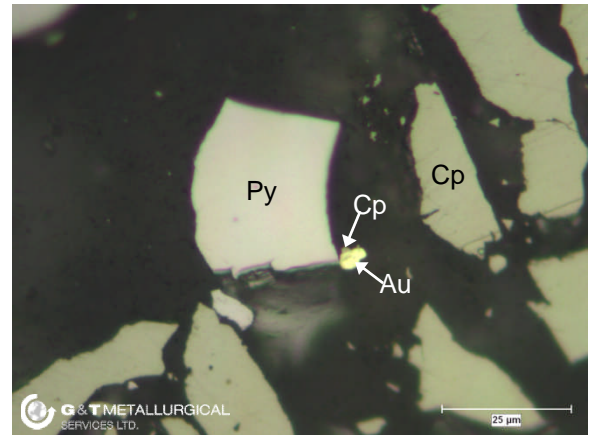

Particle 3

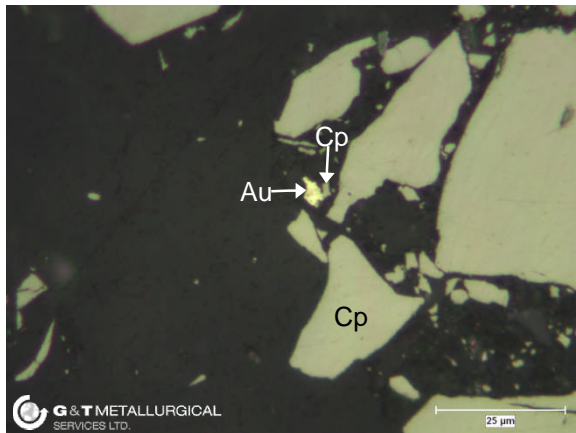

Particle 4

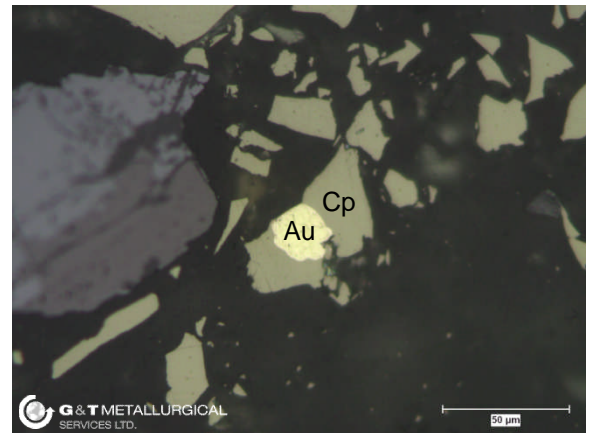

Particle 5

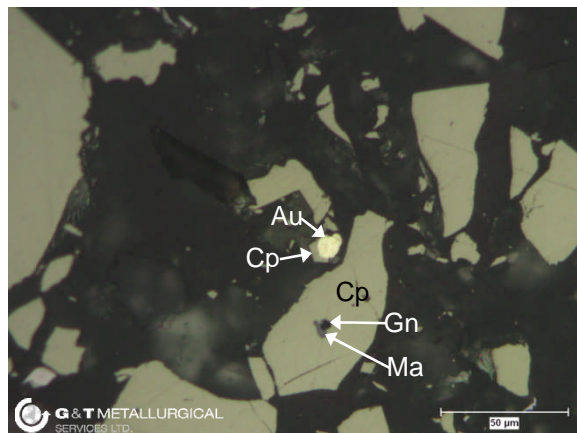

*Au-Gold, Cp-Chalcopyrite, Py-Pyrite, Ma-Magnetite, He-Hematite, Gn-Gangue.

APPENDIX I – KM2543

SAMPLE ORIGIN

1.0 Sample Origin

Samples for the Red Chris project were received at G&T Metallurgical Services Ltd. on December 21, 2009. The shipment contained 223 samples in the form of quarter drill core, weighing a total of 960 kilograms. The mass and identification of each sample can be located in Table I-1.

Upon receipt, samples were placed into two composites, as instructed by the client. The samples used in the construction of each composite are listed in Table I-2. The samples were then stage crushed to -6 mesh, homogenized, and rotary split into 2 kilogram charges. Representative cuts were removed and assayed for elements of interest in this project as displayed in Table I-3.

A map provided by Red Chris geological staff is also attached, showing the location of the metallurgical sampling drill holes.

TABLE I-1
MASS AND IDENTIFICATION OF SAMPLES RECEIVED

Sample ID	Mass kg	Sample ID	Mass kg
RC-07-335 / 486 826	2.6	RC-09-345 / 489 541	5.3
RC-07-335 / 486 827	1.4	RC-09-345 / 489 542	4.7
RC-07-335 / 486 828	2.5	RC-09-345 / 489 543	5.1
RC-07-335 / 486 829	2.4	RC-09-345 / 489 545	5.3
RC-07-335 / 486 831	2.1	RC-09-345 / 489 546	5.1
RC-07-335 / 486 832	2.2	RC-09-345 / 489 547	4.3
RC-07-335 / 486 833	3.2	RC-09-345 / 489 548	5.5
RC-07-335 / 486 834	2.3	RC-09-345 / 489 550	5.5
RC-07-335 / 486 836	2.8	RC-09-345 / 489 551	5.0
RC-07-335 / 486 837	2.4	RC-09-345 / 489 552	5.2
RC-07-335 / 486 838	2.6	RC-09-345 / 489 553	3.0
RC-07-335 / 486 839	2.8	RC-09-345 / 489 554	2.1
RC-07-335 / 486 840	2.6	RC-09-345 / 489 555	4.2
RC-07-335 / 486 841	2.6	RC-09-345 / 489 557	5.2
RC-07-335 / 486 842	2.6	RC-09-345 / 489 558	5.2
RC-07-335 / 486 843	3.3	RC-09-345 / 489 559	5.4
RC-07-335 / 486 845	3.6	RC-09-345 / 489 560	5.2
RC-07-335 / 486 846	2.1	RC-09-345 / 489 561	4.8
RC-07-335 / 486 847	3.3	RC-09-345 / 489 562	4.3
RC-07-335 / 486 848	2.2	RC-09-345 / 489 564	4.1
RC-07-335 / 486 850	2.4	RC-09-345 / 489 565	4.7
RC-07-335 / 486 851	2.7	RC-09-345 / 489 566	4.6
RC-07-335 / 486 852	2.8	RC-09-345 / 489 567	3.7
RC-09-345 / 489 322	5.1	RC-09-345 / 489 569	4.6
RC-09-345 / 489 323	2.5	RC-09-345 / 489 570	3.3
RC-09-345 / 489 324	3.2	RC-09-347 / 490 991	3.5
RC-09-345 / 489 325	5.3	RC-09-347 / 490 992	4.4
RC-09-345 / 489 327	5.8	RC-09-347 / 490 993	5.4
RC-09-345 / 489 328	5.7	RC-09-347 / 490 994	4.5
RC-09-345 / 489 329	2.8	RC-09-347 / 490 995	4.9
RC-09-345 / 489 330	2.7	RC-09-347 / 490 996	4.5
RC-09-345 / 489 332	5.2	RC-09-347 / 490 997	4.0
RC-09-345 / 489 333	5.6	RC-09-347 / 490 998	5.2
RC-09-345 / 489 334	4.7	RC-09-347 / 490 999	2.3
RC-09-345 / 489 335	6.1	RC-09-347 / 491 000	4.6
RC-09-345 / 489 337	5.2	RC-09-347 / 906 001	3.2
RC-09-345 / 489 338	0.9	RC-09-347 / 906 002	4.6
RC-09-345 / 489 339	4.5	RC-09-347 / 906 003	5.0
RC-09-345 / 489 340	6.1	RC-09-347 / 906 004	4.7
RC-09-345 / 489 341	5.4	RC-09-347 / 906 006	4.8
RC-09-345 / 489 342	5.1	RC-09-347 / 906 008	4.1
RC-09-345 / 489 344	4.8	RC-09-347 / 906 010	1.2
RC-09-345 / 489 345	5.0	RC-09-347 / 906 011	3.5
RC-09-345 / 489 346	2.9	RC-09-347 / 906 012	4.9
RC-09-345 / 489 536	1.9	RC-09-347 / 906 013	5.0
RC-09-345 / 489 537	5.1	RC-09-347 / 906 014	4.8
RC-09-345 / 489 538	5.2	RC-09-347 / 906 015	5.0
RC-09-345 / 489 540	4.7	RC-09-347 / 906 016	4.6

TABLE I-1 continued
MASS AND IDENTIFICATION OF SAMPLES RECEIVED

Sample ID	Mass kg	Sample ID	Mass kg
RC-09-347 / 906 018	4.6	RC-09-348 / 900 468	1.0
RC-09-347 / 906 019	4.8	RC-09-349 / 906 787	4.9
RC-09-347 / 906 020	4.9	RC-09-349 / 906 788	0.5
RC-09-347 / 906 021	4.9	RC-09-349 / 906 789	4.9
RC-09-347 / 906 022	1.0	RC-09-349 / 906 790	5.6
RC-09-348 / 900 416	3.7	RC-09-349 / 906 791	5.4
RC-09-348 / 900 417	0.9	RC-09-349 / 906 793	5.5
RC-09-348 / 900 420	4.7	RC-09-349 / 906 794	4.7
RC-09-348 / 900 421	5.3	RC-09-350 / 901 059	5.8
RC-09-348 / 900 423	5.5	RC-09-350 / 901 060	4.4
RC-09-348 / 900 424	5.1	RC-09-350 / 901 061	6.2
RC-09-348 / 900 425	4.5	RC-09-350 / 901 062	5.4
RC-09-348 / 900 427	5.3	RC-09-350 / 901 064	2.4
RC-09-348 / 900 428	0.7	RC-09-350 / 901 065	2.7
RC-09-348 / 900 429	4.0	RC-09-350 / 901 066	5.9
RC-09-348 / 900 430	2.1	RC-09-350 / 901 068	5.8
RC-09-348 / 900 431	2.4	RC-09-350 / 901 069	5.3
RC-09-348 / 900 432	2.7	RC-09-350 / 901 070	5.8
RC-09-348 / 900 433	1.7	RC-09-350 / 901 071	5.9
RC-09-348 / 900 434	4.7	RC-09-350 / 901 073	4.0
RC-09-348 / 900 436	5.2	RC-09-350 / 901 074	5.5
RC-09-348 / 900 437	4.8	RC-09-350 / 901 075	5.7
RC-09-348 / 900 438	5.6	RC-09-350 / 901 076	5.7
RC-09-348 / 900 439	4.1	RC-09-350 / 901 077	5.3
RC-09-348 / 900 440	6.8	RC-09-350 / 901 078	5.1
RC-09-348 / 900 441	4.7	RC-09-350 / 901 079	5.8
RC-09-348 / 900 442	5.2	RC-09-350 / 901 080	2.3
RC-09-348 / 900 443	5.6	RC-09-350 / 901 081	3.1
RC-09-348 / 900 444	3.6	RC-09-350 / 901 082	4.3
RC-09-348 / 900 445	1.4	RC-09-350 / 901 084	5.2
RC-09-348 / 900 446	5.7	RC-09-350 / 901 085	5.6
RC-09-348 / 900 448	4.4	RC-09-350 / 901 086	4.4
RC-09-348 / 900 449	5.3	RC-09-350 / 901 088	6.8
RC-09-348 / 900 450	5.3	RC-09-350 / 901 089	5.1
RC-09-348 / 900 452	4.9	RC-09-350 / 901 090	5.4
RC-09-348 / 900 453	0.6	RC-09-350 / 901 091	2.5
RC-09-348 / 900 454	3.8	RC-09-350 / 901 092	1.9
RC-09-348 / 900 455	0.5	RC-09-350 / 901 093	6.2
RC-09-348 / 900 456	4.9	RC-09-350 / 901 094	5.5
RC-09-348 / 900 458	4.5	RC-09-350 / 901 095	5.7
RC-09-348 / 900 459	2.6	RC-09-350 / 901 096	5.5
RC-09-348 / 900 460	2.1	RC-09-350 / 901 098	2.0
RC-09-348 / 900 461	5.2	RC-09-350 / 901 099	3.4
RC-09-348 / 900 463	1.8	RC-09-350 / 901 100	5.5
RC-09-348 / 900 464	3.2	RC-09-350 / 901 101	5.7
RC-09-348 / 900 465	3.9	RC-09-350 / 901 102	4.7
RC-09-348 / 900 466	2.6	RC-09-350 / 901 103	5.7
RC-09-348 / 900 467	2.3	RC-09-350 / 901 104	5.7

TABLE I-1 continued
MASS AND IDENTIFICATION OF SAMPLES RECEIVED

Sample ID	Mass kg
RC-09-350 / 901 105	5.5
RC-09-350 / 901 106	5.8
RC-09-350 / 901 110	5.8
RC-09-350 / 901 115	5.0
RC-09-350 / 901 117	5.1
RC-09-350 / 901 118	5.2
RC-09-350 / 901 119	4.8
RC-09-350 / 901 120	5.0
RC-09-350 / 901 121	4.9
RC-09-350 / 901 122	5.4
RC-09-350 / 901 123	5.5
RC-09-350 / 901 124	5.5
RC-09-350 / 901 125	5.4
RC-09-350 / 901 126	5.1
RC-09-350 / 901 128	5.1
RC-09-350 / 901 129	5.6
RC-09-350 / 901 130	5.2
RC-09-350 / 901 131	5.3
RC-09-350 / 901 132	5.2
RC-09-350 / 901 134	5.0
RC-09-350 / 901 135	5.7
RC-09-350 / 901 136	5.3
RC-09-350 / 901 137	5.4
RC-09-350 / 901 138	5.3
RC-09-350 / 901 139	5.3
RC-09-350 / 901 141	4.4
RC-09-350 / 901 142	5.3
RC-09-350 / 901 143	5.3
RC-09-350 / 901 145	4.9
RC-09-350 / 901 146	5.6
RC-09-350 / 901 147	5.3

TABLE I-2A
CONSTRUCTION OF HIGH GOLD-COPPER RATIO
EAST ZONE COMPOSITE

Hole ID	From	To	Sample
RC09-345	490.0	492.5	489332
RC09-345	492.5	495.0	489333
RC09-345	495.0	497.5	489334
RC09-345	497.5	500.0	489335
RC09-345	500.0	502.5	489337
RC09-345	502.5	502.8	489338
RC09-345	502.8	505.0	489339
RC09-345	505.0	507.5	489340
RC09-345	507.5	510.0	489341
RC09-349	905.0	907.5	906787
RC09-349	907.9	910.0	906789
RC09-349	910.0	912.5	906790
RC09-349	912.5	915.0	906791
RC09-349	915.0	917.5	906793
RC09-349	917.5	919.9	906794
RC09-350	620.0	622.5	901103
RC09-350	622.5	625.0	901104
RC09-350	625.0	627.5	901105
RC09-350	627.5	630.0	901106
RC09-350	635.0	637.5	901110
RC09-350	645.0	647.5	901115
RC09-350	647.5	650.0	901117

TABLE I-2B
CONSTRUCTION OF HIGH BORNITE
EAST ZONE COMPOSITE

Hole ID	From	To	Sample
RC09-347	730.0	732.5	906006
RC09-347	732.5	735.0	906008
RC09-347	735.0	735.6	906010
RC09-347	735.6	737.5	906011
RC09-347	737.5	740.0	906012
RC09-347	740.0	742.5	906013
RC09-347	742.5	745.0	906014
RC09-348	830.0	832.5	900437
RC09-348	832.5	835.0	900438
RC09-348	835.0	837.5	900439
RC09-348	837.5	840.2	900440
RC09-348	840.2	842.5	900441
RC09-348	842.5	845.0	900442
RC09-348	845.0	847.5	900443
RC09-348	847.5	849.3	900444
RC09-348	849.3	850.0	900445
RC09-348	850.0	852.5	900446
RC09-348	852.5	855.0	900448
RC09-348	855.0	857.5	900449
RC09-348	857.5	860.0	900450
RC09-348	860.0	862.5	900452
RC09-345	922.5	925.0	489560
RC09-345	925.0	927.5	489561
RC09-345	927.5	930.0	489562
RC09-345	930.0	932.5	489564
RC09-345	932.5	935.0	489565
RC09-345	935.0	937.5	489566
RC09-345	937.5	940.0	489567

TABLE I-3
HEAD ASSAY DATA

Composite	Assay - percent or grams/tonne								
	Cu	Fe	S	Ag	Au	Hg	C	Cu(Ox)	Cu(CN)
High Au-Cu Ratio East Zone	2.84	5.9	3.71	6	5.06	0.7	1.65	0.02	0.07
High Bornite East Zone	1.44	4.6	0.85	6	1.95	0.8	2.61	0.02	0.94

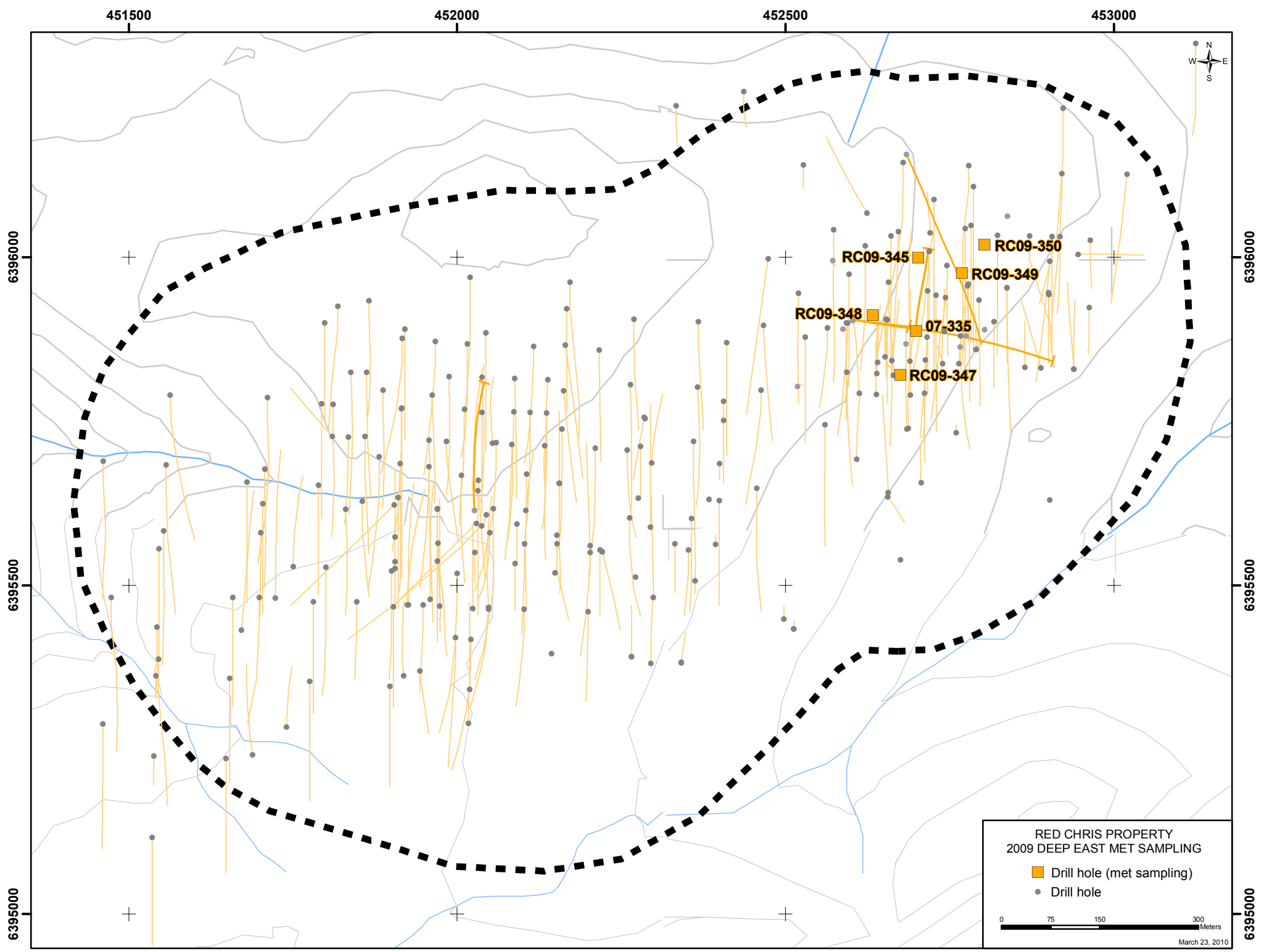

APPENDIX II – KM2543

FLOTATION TEST DATA

INDEX

<u>TEST</u>	<u>PAGE</u>	
1	Rougher Test – High Gold Copper Ratio East Zone	1
2	Rougher Test – High Bornite East Zone	3
3	Cleaner Test – High Gold Copper Ratio East Zone	5
4	Cleaner Test – High Bornite East Zone	7
5	Rougher Test – High Gold Copper Ratio East Zone	9
6	Rougher Test – High Bornite East Zone	11
7	Cleaner Test – High Gold Copper Ratio East Zone	13
8	Cleaner Test – High Bornite East Zone	15
9	Cleaner Test – High Gold Copper Ratio East Zone	17
10	Cleaner Test – High Bornite East Zone	19
11	Cleaner Test – High Gold Copper Ratio East Zone	21
12	Cleaner Test – High Bornite East Zone	23
13	Rougher Test – High Gold Copper Ratio East Zone	25
14	Rougher Test – High Bornite East Zone	27
15	Gravity Test – Test 1 Pyrite Rougher Tail	29
16	Gravity Test – Test 2 Pyrite Rougher Tail	31
17	Locked Cycle Test – High Gold Copper Ratio East Zone	33
18	Locked Cycle Test – High Bornite East Zone	38
19	Gravity Test – Test 17 Copper First Cleaner Tail I-V	43

PROJECT NO: KM2543-01

PURPOSE: Preliminary Rougher Test.

PROCEDURE: Perform a two product rougher test.

FEED: 2 kg of High Gold Copper Ratio East Zone Composite ground to a nominal 157 μ m K₈₀.

FLWSHEET: 1

Stage	Reagents Added g/tonne			Time (minutes)			pH
	PAX		MIBC	Grind	Cond.	Float	
Primary Grind				12			8.7
<u>COPPER CIRCUIT:</u>							
Rougher 1	0		15		1	2	8.8
Rougher 2	0.5		15		1	2	8.7
Rougher 3	1.5		0		1	4	8.3
Rougher 4	2		8		1	4	7.8
<u>PYRITE CIRCUIT:</u>							
Rougher 1	20		30		1	4	7.6
Rougher 2	20		30		1	4	7.3

Flotation Data	Rougher	
Flotation Machine	D2A	
Cell Size in liters	4.4	
Aspiration		Air
Impeller Speed in rpm	1100	

Grinding Data	Primary Grind
Mill:	M2-Mild
Charge/Material:	20kg-Mild
Water:	1000 ml

KM2543-01 High Gold Copper Ratio East ZoneOverall Metallurgical Balance

Product	Weight		Assay - percent or g/t						Distribution - percent					
	grams	%	Cu	Fe	S	Ag	Au	Hg	Cu	Fe	S	Ag	Au	Hg
Cu Rougher 1	134.2	6.7	29.0	29.2	31.4	45	43.9	0.5	65.1	30.4	53.8	50.0	52.6	6.5
Cu Rougher 2	64.4	3.2	14.2	23.8	23.4	36	35.7	0.5	15.3	11.9	19.2	19.4	20.6	3.1
Cu Rougher 3	129.8	6.5	6.30	14.7	12.5	17	13.3	0.5	13.7	14.8	20.7	18.5	15.5	6.3
Cu Rougher 4 *	54.3	2.7	3.04	8.3	4.22	7	5.02	0.6	2.8	3.5	2.9	3.4	2.4	3.2
Py Rougher 1	33.5	1.7	2.65	7.9	3.30	6	3.89	0.7	1.5	2.1	1.4	1.7	1.2	2.3
Py Rougher 2	19.6	1.0	0.66	6.1	1.25	4	2.11	1.7	0.2	0.9	0.3	0.6	0.4	3.2
Py Rougher Tail	1561.0	78.2	0.06	3.0	0.08	1	0.53	0.5	1.5	36.4	1.6	6.5	7.4	75.5
Feed	1996.8	100	2.99	6.4	3.92	6	5.60	0.5	100	100	100	100	100	100

*Au value estimated, reassay required.

KM2543-01 High Gold Copper Ratio East ZoneCumulative Metallurgical Balance

Cumulative Product	Cum. Weight		Assay - percent or g/t						Distribution - percent					
	grams	%	Cu	Fe	S	Ag	Au	Hg	Cu	Fe	S	Ag	Au	Hg
Product 1	134.2	6.7	29.0	29.2	31.4	45	43.9	0.5	65.1	30.4	53.8	50.0	52.6	6.5
Product 1 to 2	198.6	9.9	24.2	27.4	28.8	42	41.2	0.5	80.4	42.3	73.1	69.3	73.2	9.6
Product 1 to 3	328.4	16.4	17.1	22.4	22.4	32	30.2	0.5	94.1	57.2	93.8	87.9	88.7	15.9
Product 1 to 4	382.7	19.2	15.1	20.4	19.8	29	26.6	0.5	96.8	60.7	96.7	91.2	91.1	19.0
Product 5	33.5	1.7	2.65	7.9	3.30	6	3.89	0.7	1.5	2.1	1.4	1.7	1.2	2.3
Product 5 to 6	53.1	2.7	1.92	7.2	2.54	5	3.23	1.1	1.7	3.0	1.7	2.3	1.5	5.5
Product 7	1561.0	78.2	0.06	3.0	0.08	1	0.53	0.5	1.5	36.4	1.6	6.5	7.4	75.5
Feed	1996.8	100	2.99	6.4	3.92	6	5.60	0.5	100	100	100	100	100	100

PROJECT NO: KM2543-02

PURPOSE: Preliminary Rougher Test.

PROCEDURE: Perform a two product rougher test.

FEED: 2 kg of High Bornite East Zone Composite ground to a nominal 154 μ m K₈₀.

FLWSHEET: 1

Stage	Reagents Added g/tonne			Time (minutes)			pH
	PAX		MIBC	Grind	Cond.	Float	
Primary Grind				17			8.0
<u>COPPER CIRCUIT:</u>							
Rougher 1	0		30		1	2	8.1
Rougher 2	1		24		1	2	8.0
Rougher 3	1		15		1	2	8.0
Rougher 4	1		15		1	2	8.0
<u>PYRITE CIRCUIT:</u>							
Rougher 1	20		30		1	4	8.1
Rougher 2	20		30		1	4	8.1

Flotation Data	Rougher	
Flotation Machine	D2A	
Cell Size in liters	4.4	
Aspiration		Air
Impeller Speed in rpm	1100	

Grinding Data	Primary Grind
Mill:	M2-Mild
Charge/Material:	20kg-Mild
Water:	1000 ml

KM2543-02 High Bornite East ZoneOverall Metallurgical Balance

Product	Weight		Assay - percent or g/t						Distribution - percent					
	grams	%	Cu	Fe	S	Ag	Au	Hg	Cu	Fe	S	Ag	Au	Hg
Cu Rougher 1	46.1	2.3	35.0	14.7	20.3	148	39.8	1	57.3	6.5	56.9	52.4	35.8	2.2
Cu Rougher 2	40.4	2.0	20.4	8.7	9.45	96	37.8	1	29.2	3.4	23.2	29.8	29.8	2.0
Cu Rougher 3	29.3	1.5	4.26	10.6	2.88	26	28.4	1	4.4	3.0	5.1	5.7	16.3	1.4
Cu Rougher 4	31.5	1.6	1.59	4.5	1.22	9	3.72	1	1.8	1.4	2.3	2.2	2.3	1.4
Py Rougher 1	43.1	2.2	1.05	4.4	0.76	6	2.61	3	1.6	1.8	2.0	2.1	2.2	5.7
Py Rougher 2	29.3	1.5	0.77	4.3	0.62	4	2.30	1	0.8	1.2	1.1	1.0	1.3	1.7
Py Rougher Tail	1761.5	88.9	0.08	4.9	0.09	1	0.36	1	4.9	82.7	9.3	6.8	12.3	85.6
Feed	1981.2	100	1.42	5.2	0.83	7	2.58	1	100	100	100	100	100	100

KM2543-02 High Bornite East ZoneCumulative Metallurgical Balance

Cumulative Product	Cum. Weight		Assay - percent or g/t						Distribution - percent					
	grams	%	Cu	Fe	S	Ag	Au	Hg	Cu	Fe	S	Ag	Au	Hg
Product 1	46.1	2.3	35.0	14.7	20.3	148	39.8	1	57.3	6.5	56.9	52.4	35.8	2.2
Product 1 to 2	86.5	4.4	28.2	11.9	15.2	124	38.8	1	86.5	9.9	80.1	82.2	65.6	4.2
Product 1 to 3	115.8	5.8	22.1	11.6	12.1	99	36.2	1	90.9	12.9	85.3	88.0	81.9	5.6
Product 1 to 4	147.3	7.4	17.7	10.1	9.78	80	29.3	1	92.7	14.3	87.6	90.2	84.2	7.0
Product 5	43.1	2.2	1.05	4.4	0.76	6	2.61	3	1.6	1.8	2.0	2.1	2.2	5.7
Product 5 to 6	72.4	3.7	0.94	4.4	0.71	5	2.48	2	2.4	3.0	3.1	3.1	3.5	7.4
Product 7	1761.5	88.9	0.08	4.9	0.09	1	0.36	1	4.9	82.7	9.3	6.8	12.3	85.6
Feed	1981.2	100	1.42	5.2	0.83	7	2.58	1	100	100	100	100	100	100

PROJECT NO: KM2543-03

PURPOSE: Preliminary Cleaner Test.

PROCEDURE: Perform a standard one product cleaner test.

FEED: 2 kg of High Gold Copper Ratio East Zone Composite ground to a nominal 157 μ m K₈₀.
Copper Regrind Discharge 37 μ m K₈₀.

FLWSHEET: 2

Stage	Reagents Added g/tonne			Time (minutes)			pH
	Lime	PAX	MIBC	Grind	Cond.	Float	
Primary Grind				12			9.1
COPPER CIRCUIT:							
Rougher 1		1	30		1	4	9.0
Rougher 2		1	15		1	4	8.9
Regrind	100			30			8.4
Cleaner 1	80	8	30		1	6	10.0
Cleaner 2	√	6	45		1	5	10.0
Cleaner 3	√	4	30		1	4	10.0

Grinding Data	Primary Grind	Copper Regrind
Mill:	M2-Mild	RM3-Mild
Charge/Material:	20kg-Mild	6kg-Steel
Water:	1000 ml	estimated

Flotation Data	Rougher	Cleaner
Flotation Machine	D2A	D1E
Cell Size in liters	4.4	2.2
Aspiration	Air	
Impeller Speed in rpm	1100	1200

KM2543-03 High Gold Copper Ratio East Zone
Overall Metallurgical Balance

Product	Weight		Assay - percent or g/t					Distribution - percent				
	grams	%	Cu	Fe	S	Ag	Au	Cu	Fe	S	Ag	Au
Cu Concentrate	186.1	9.3	28.7	31.7	33.8	44	44.6	92.4	48.3	87.8	75.0	84.3
Cu 3rd Cleaner Tail*	1.2	0.1	8.70	22.8	20.0	16	8.29	0.2	0.2	0.3	0.2	0.1
Cu 2nd Cleaner Tail	7.9	0.4	2.72	14.1	8.24	16	8.29	0.4	0.9	0.9	1.2	0.7
Cu 1st Cleaner Tail	151.7	7.6	0.40	8.7	1.95	4	2.15	1.1	10.8	4.1	5.7	3.3
Cu Rougher Tail	1644.0	82.6	0.21	3.0	0.30	1	0.70	6.0	39.7	6.8	18.0	11.7
Feed	1990.9	100	2.90	6.1	3.60	6	4.95	100	100	100	100	100

*Not enough sample for assay, Ag and Au values estimated.

KM2543-03 High Gold Copper Ratio East Zone
Cumulative Metallurgical Balance

Cumulative Product	Cum. Weight		Assay - percent or g/t					Distribution - percent				
	grams	%	Cu	Fe	S	Ag	Au	Cu	Fe	S	Ag	Au
Product 1	186.1	9.3	28.7	31.7	33.8	44	44.6	92.4	48.3	87.8	75.0	84.3
Product 1 to 2	187.3	9.4	28.5	31.6	33.7	44	44.4	92.6	48.5	88.2	75.2	84.4
Product 1 to 3	195.2	9.8	27.5	30.9	32.7	43	43.0	93.0	49.5	89.1	76.3	85.0
Product 1 to 4	346.9	17.4	15.6	21.2	19.2	26	25.1	94.0	60.3	93.2	82.0	88.3
Product 5	1644.0	82.6	0.21	3.0	0.30	1	0.70	6.0	39.7	6.8	18.0	11.7
Feed	1990.9	100	2.90	6.1	3.60	6	4.95	100	100	100	100	100

PROJECT NO: KM2543-04

PURPOSE: Preliminary Cleaner Test.

PROCEDURE: Perform a standard one product cleaner test.

FEED: 2 kg of High Bornite East Zone Composite ground to a nominal 154 μ m K₈₀.
Copper Regrind Discharge 26 μ m K₈₀.

FLWSHEET: 2

Stage	Reagents Added g/tonne			Time (minutes)			pH
	Lime	PAX	MIBC	Grind	Cond.	Float	
Primary Grind				17			9.3
<u>COPPER CIRCUIT:</u>							
Rougher 1		1	60		1	4	9.3
Rougher 2		1	30		1	4	9.3
Regrind	100			16			9.7
Cleaner 1	15	8	60		1	6	10.0
Cleaner 2	√	8	60		1	5	10.0
Cleaner 3	√	8	60		1	4	10.0

Grinding Data	Primary Grind	Copper Regrind
Mill:	M2-Mild	RM3-Mild
Charge/Material:	20kg-Mild	6kg-Steel
Water:	1000 ml	estimated

Flotation Data	Rougher	Cleaner
Flotation Machine	D2A	D1E
Cell Size in liters	4.4	2.2
Aspiration	Air	
Impeller Speed in rpm	1100	1200

KM2543-04 High Bornite East Zone
Overall Metallurgical Balance

Product	Weight		Assay - percent or g/t					Distribution - percent				
	grams	%	Cu	Fe	S	Ag	Au	Cu	Fe	S	Ag	Au
Cu Concentrate	51.3	2.6	49.6	17.5	25.5	220	66.3	89.4	9.3	81.9	77.9	79.7
Cu 3rd Cleaner Tail*	1.0	0.1	20.0	10.1	10.5	18	4.32	0.7	0.1	0.7	0.1	0.1
Cu 2nd Cleaner Tail	10.4	0.5	2.99	5.2	1.68	18	4.32	1.1	0.6	1.1	1.3	1.1
Cu 1st Cleaner Tail	104.6	5.3	0.49	4.8	0.37	4	1.21	1.8	5.2	2.4	3.0	3.0
Cu Rougher Tail	1820.4	91.6	0.11	4.5	0.12	1	0.38	7.0	84.9	14.0	17.6	16.1
Feed	1987.7	100	1.43	4.9	0.80	7	2.14	100	100	100	100	100

*Not enough sample for assay, Ag and Au values estimated.

KM2543-04 High Bornite East Zone
Cumulative Metallurgical Balance

Cumulative Product	Cum. Weight		Assay - percent or g/t					Distribution - percent				
	grams	%	Cu	Fe	S	Ag	Au	Cu	Fe	S	Ag	Au
Product 1	51.3	2.6	49.6	17.5	25.5	220	66.3	89.4	9.3	81.9	77.9	79.7
Product 1 to 2	52.3	2.6	49.0	17.4	25.2	216	65.1	90.1	9.4	82.5	78.1	79.8
Product 1 to 3	62.7	3.2	41.4	15.3	21.3	183	55.0	91.2	9.9	83.6	79.4	80.9
Product 1 to 4	167.3	8.4	15.8	8.8	8.21	71	21.4	93.0	15.1	86.0	82.4	83.9
Product 5	1820.4	91.6	0.11	4.5	0.12	1	0.38	7.0	84.9	14.0	17.6	16.1
Feed	1987.7	100	1.43	4.9	0.80	7	2.14	100	100	100	100	100

PROJECT NO: KM2543-05

PURPOSE: To Repeat Test 1 with a pH of 10.5 in the Rougher.

PROCEDURE: Perform a standard two product rougher test.

FEED: 2 kg of High Gold Copper Ratio East Zone Composite ground to a nominal 157 μ m K₈₀.

FLWSHEET: 1

Stage	Reagents Added g/tonne			Time (minutes)			pH
	Lime	PAX	MIBC	Grind	Cond.	Float	
Primary Grind	100			12			9.4
<u>COPPER CIRCUIT:</u>							
Rougher 1	450	0	15		1	2	10.5
Rougher 2	0	1	0		1	2	10.6
Rougher 3	0	2	15		1	2	10.5
Rougher 4	√	2	15		1	2	10.5
<u>PYRITE CIRCUIT</u>							
Rougher 1		20	0		1	4	10.3
Rougher 2		20	15		1	4	9.9

Flotation Data	Rougher	
Flotation Machine	D2A	
Cell Size in liters	4.4	
Aspiration		Air
Impeller Speed in rpm	1100	

Grinding Data	Primary Grind
Mill:	M2-Mild
Charge/Material:	20kg-Mild
Water:	1000 ml

KM2543-05 High Gold Copper Ratio East ZoneOverall Metallurgical Balance

Product	Weight		Assay - percent or g/t					Distribution - percent				
	grams	%	Cu	Fe	S	Ag	Au	Cu	Fe	S	Ag	Au
Cu Rougher 1	140.9	7.1	29.0	27.0	29.5	40	37.5	70.1	30.9	56.1	50.1	53.9
Cu Rougher 2	74.4	3.7	9.30	20.6	19.8	31	38.9	11.9	12.5	19.9	20.7	29.5
Cu Rougher 3	73.4	3.7	5.43	14.5	11.0	11	7.85	6.8	8.6	10.9	7.2	5.9
Cu Rougher 4	45.8	2.3	3.98	10.4	5.93	9	5.26	3.1	3.9	3.7	3.6	2.5
Py Rougher 1	48.3	2.4	7.40	12.1	9.57	12	6.07	6.1	4.7	6.2	4.9	3.0
Py Rougher 2	20.4	1.0	0.76	6.8	1.33	4	2.26	0.3	1.1	0.4	0.8	0.5
Py Rougher Tail	1589.9	79.8	0.06	3.0	0.13	1	0.29	1.6	38.2	2.8	12.7	4.7
Feed	1993.1	100	2.92	6.2	3.72	6	4.92	100	100	100	100	100

KM2543-05 High Gold Copper Ratio East ZoneCumulative Metallurgical Balance

Cumulative Product	Cum. Weight		Assay - percent or g/t					Distribution - percent				
	grams	%	Cu	Fe	S	Ag	Au	Cu	Fe	S	Ag	Au
Product 1	140.9	7.1	29.0	27.0	29.5	40	37.5	70.1	30.9	56.1	50.1	53.9
Product 1 to 2	215.3	10.8	22.2	24.8	26.1	37	38.0	82.0	43.4	76.0	70.8	83.5
Product 1 to 3	288.7	14.5	17.9	22.2	22.3	30	30.3	88.9	52.0	86.9	78.1	89.3
Product 1 to 4	334.5	16.8	16.0	20.6	20.1	28	26.9	92.0	55.9	90.6	81.6	91.8
Product 5	48.3	2.4	7.40	12.1	9.57	12	6.07	6.1	4.7	6.2	4.9	3.0
Product 5 to 6	68.7	3.4	5.43	10.5	7.12	9	4.94	6.4	5.9	6.6	5.7	3.5
Product 7	1589.9	79.8	0.06	3.0	0.13	1	0.29	1.6	38.2	2.8	12.7	4.7
Feed	1993.1	100	2.92	6.2	3.72	6	4.92	100	100	100	100	100

PROJECT NO: KM2543-06

PURPOSE: To Repeat Test 2 with a pH of 10.5 in the Rougher.

PROCEDURE: Perform a standard two product rougher test.

FEED: 2 kg of High Bornite East Zone Composite ground to a nominal 154 μ m K₈₀.

FLWSHEET: 1

Stage	Reagents Added g/tonne			Time (minutes)			pH
	Lime	PAX	MIBC	Grind	Cond.	Float	
Primary Grind	100			17			9.5
<u>COPPER CIRCUIT:</u>							
Rougher 1	700	0	15		1	2	10.6
Rougher 2	0	0.5	60		1	2	10.7
Rougher 3	0	1.5	0		1	2	10.6
Rougher 4	0	2	15		1	2	10.5
<u>PYRITE CIRCUIT</u>							
Rougher 1		20	0		1	4	10.3
Rougher 2		20	0		1	4	9.9

Flotation Data	Rougher	
Flotation Machine	D2B	
Cell Size in liters	4.4	
Aspiration		Air
Impeller Speed in rpm	1100	

Grinding Data	Primary Grind
Mill:	M2-Mild
Charge/Material:	20kg-Mild
Water:	1000 ml

KM2543-06 High Bornite East ZoneOverall Metallurgical Balance

Product	Weight		Assay - percent or g/t					Distribution - percent				
	grams	%	Cu	Fe	S	Ag	Au	Cu	Fe	S	Ag	Au
Cu Rougher 1	47.3	2.4	29.4	13.0	17.8	128	35.7	50.5	6.5	49.0	42.6	34.2
Cu Rougher 2	58.0	2.9	17.2	7.5	9.10	82	23.5	36.2	4.6	30.7	33.4	27.6
Cu Rougher 3	51.2	2.6	3.37	5.1	2.44	20	24.4	6.3	2.8	7.3	7.2	25.3
Cu Rougher 4	24.0	1.2	1.38	4.4	1.14	9	2.68	1.2	1.1	1.6	1.5	1.3
Py Rougher 1	24.3	1.2	0.77	4.0	0.68	6	1.85	0.7	1.0	1.0	1.0	0.9
Py Rougher 2	18.5	0.9	0.70	4.0	0.53	5	1.43	0.5	0.8	0.6	0.7	0.5
Py Rougher Tail	1764.9	88.8	0.07	4.5	0.10	1	0.29	4.6	83.3	9.9	13.7	10.2
Feed	1988.2	100	1.38	4.8	0.86	7	2.48	100	100	100	100	100

KM2543-06 High Bornite East ZoneCumulative Metallurgical Balance

Cumulative Product	Cum. Weight		Assay - percent or g/t					Distribution - percent				
	grams	%	Cu	Fe	S	Ag	Au	Cu	Fe	S	Ag	Au
Product 1	47.3	2.4	29.4	13.0	17.8	128	35.7	50.5	6.5	49.0	42.6	34.2
Product 1 to 2	105.3	5.3	22.7	10.0	13.0	102	29.0	86.8	11.1	79.7	76.0	61.8
Product 1 to 3	156.5	7.9	16.4	8.4	9.55	76	27.5	93.0	13.8	87.0	83.2	87.0
Product 1 to 4	180.5	9.1	14.4	7.8	8.43	67	24.2	94.2	14.9	88.6	84.7	88.3
Product 5	24.3	1.2	0.77	4.0	0.68	6	1.85	0.7	1.0	1.0	1.0	0.9
Product 5 to 6	42.8	2.2	0.74	4.0	0.62	5	1.67	1.2	1.8	1.5	1.7	1.4
Product 7	1764.9	88.8	0.07	4.5	0.10	1	0.29	4.6	83.3	9.9	13.7	10.2
Feed	1988.2	100	1.38	4.8	0.86	7	2.48	100	100	100	100	100

PROJECT NO: KM2543-07

PURPOSE: To Repeat Test 3 at a Finer Re grind.

PROCEDURE: Perform a standard one product cleaner test.

FEED: 2 kg of High Gold Copper Ratio East Zone Composite ground to a nominal 157 μ m K₈₀.
Copper Re grind Discharge - 26 μ m K₈₀

FLWSHEET: 2

Stage	Reagents Added g/tonne			Time (minutes)			pH
	Lime	PAX	MIBC	Grind	Cond.	Float	
Primary Grind				12			9.0
COPPER CIRCUIT:							
Rougher 1		1	30		1	4	8.9
Rougher 2		1	30		1	4	8.9
Regrind	100			8			8.6
Cleaner 1	100	10	15		1	6	10.0
Cleaner 2	√	8	30		1	5	10.0
Cleaner 3	√	6	30		1	4	10.0

Grinding Data	Primary Grind	Copper Re grind
Mill:	M2-Mild	Stirred Mill
Charge/Material:	20kg-Mild	1.2kg-Beads
Water:	1000 ml	estimated

Flotation Data	Rougher	Cleaner
Flotation Machine	D2A	D1E
Cell Size in liters	4.4	2.2
Aspiration	Air	
Impeller Speed in rpm	1100	1200

KM2543-07 High Gold Copper Ratio East ZoneOverall Metallurgical Balance

Product	Weight		Assay - percent or g/t					Distribution - percent				
	grams	%	Cu	Fe	S	Ag	Au	Cu	Fe	S	Ag	Au
Cu Concentrate	171.4	8.6	31.5	31.2	35.0	44	42.1	90.5	42.5	75.5	66.6	72.0
Cu 3rd Cleaner Tail*	1.8	0.1	8.40	18.5	17.1	37	42.9	0.3	0.3	0.4	0.6	0.8
Cu 2nd Cleaner Tail	9.5	0.5	2.85	13.9	8.49	37	42.9	0.5	1.1	1.0	3.1	4.1
Cu 1st Cleaner Tail	154.4	7.8	0.49	12.6	7.23	8	6.54	1.3	15.5	14.1	10.9	10.1
Cu Rougher Tail	1654.5	83.1	0.27	3.1	0.43	1	0.79	7.5	40.7	9.0	18.9	13.1
Feed	1991.6	100	2.99	6.3	3.99	6	5.04	100	100	100	100	100

*Not enough sample for assay, Ag and Au values estimated.

KM2543-07 High Gold Copper Ratio East ZoneCumulative Metallurgical Balance

Cumulative Product	Cum. Weight		Assay - percent or g/t					Distribution - percent				
	grams	%	Cu	Fe	S	Ag	Au	Cu	Fe	S	Ag	Au
Product 1	171.4	8.6	31.5	31.2	35.0	44	42.1	90.5	42.5	75.5	66.6	72.0
Product 1 to 2	173.2	8.7	31.3	31.1	34.8	44	42.2	90.8	42.8	75.9	67.2	72.8
Product 1 to 3	182.7	9.2	29.8	30.2	33.4	44	42.2	91.2	43.9	76.9	70.2	76.9
Product 1 to 4	337.1	16.9	16.4	22.1	21.4	27	25.9	92.5	59.3	91.0	81.1	86.9
Product 5	1654.5	83.1	0.27	3.1	0.43	1	0.79	7.5	40.7	9.0	18.9	13.1
Feed	1991.6	100	2.99	6.3	3.99	6	5.04	100	100	100	100	100

PROJECT NO: KM2543-08

PURPOSE: To Repeat Test 4 at a Coarser Re grind.

PROCEDURE: Perform a standard one product cleaner test.

FEED: 2 kg of High Bornite East Zone Composite ground to a nominal 154 μ m K₈₀.
Copper Re grind Discharge - 36 μ m K₈₀

FLWSHEET: 2

Stage	Reagents Added g/tonne			Time (minutes)			pH
	Lime	PAX	MIBC	Grind	Cond.	Float	
Primary Grind				17			9.4
<u>COPPER CIRCUIT:</u>							
Rougher 1		1	60		1	4	9.1
Rougher 2		1	60		1	4	9.0
Regrind	100			8			9.6
Cleaner 1	20	6	60		1	6	10.0
Cleaner 2	√	4	60		1	5	10.0
Cleaner 3	√	2	90		1	4	10.0

Grinding Data	Primary Grind	Copper Re grind
Mill:	M2-Mild	RM3- Mild
Charge/Material:	20kg-Mild	6kg-Steel
Water:	1000 ml	estimated

Flotation Data	Rougher	Cleaner
Flotation Machine	D2A	D1E
Cell Size in liters	4.4	2.2
Aspiration	Air	
Impeller Speed in rpm	1100	1200

KM2543-08 High Bornite East ZoneOverall Metallurgical Balance

Product	Weight		Assay - percent or g/t					Distribution - percent				
	grams	%	Cu	Fe	S	Ag	Au	Cu	Fe	S	Ag	Au
Cu Concentrate	52.2	2.6	47.0	17.1	26.3	204	58.0	88.9	9.3	81.5	76.9	69.5
Cu 3rd Cleaner Tail*	1.9	0.1	13.3	8.1	7.18	18	9.15	0.9	0.2	0.8	0.2	0.4
Cu 2nd Cleaner Tail	10.7	0.5	2.59	4.7	1.53	18	9.15	1.0	0.5	1.0	1.4	2.2
Cu 1st Cleaner Tail	110.7	5.6	0.46	4.5	0.35	4	3.58	1.8	5.1	2.3	3.2	9.1
Cu Rougher Tail	1805.0	91.1	0.11	4.5	0.13	1	0.45	7.3	84.9	14.4	18.3	18.8
Feed	1980.5	100	1.39	4.9	0.85	7	2.20	100	100	100	100	100

*Not enough sample for assay, Ag and Au values estimated.

KM2543-08 High Bornite East ZoneCumulative Metallurgical Balance

Cumulative Product	Cum. Weight		Assay - percent or g/t					Distribution - percent				
	grams	%	Cu	Fe	S	Ag	Au	Cu	Fe	S	Ag	Au
Product 1	52.2	2.6	47.0	17.1	26.3	204	58.0	88.9	9.3	81.5	76.9	69.5
Product 1 to 2	54.1	2.7	45.8	16.8	25.6	197	56.3	89.8	9.4	82.4	77.2	69.9
Product 1 to 3	64.8	3.3	38.7	14.8	21.6	168	48.5	90.8	10.0	83.3	78.6	72.1
Product 1 to 4	175.5	8.9	14.6	8.3	8.21	64	20.2	92.7	15.1	85.6	81.7	81.2
Product 5	1805.0	91.1	0.11	4.5	0.13	1	0.45	7.3	84.9	14.4	18.3	18.8
Feed	1980.5	100	1.39	4.9	0.85	7	2.20	100	100	100	100	100

PROJECT NO: KM2543-09

PURPOSE: Preliminary Cleaner Test at a High pH.

PROCEDURE: Perform a standard one product cleaner test with rougher at pH 10.5 and cleaner at pH 12.0.

FEED: 2 kg of High Gold Copper Ratio East Zone Composite ground to a nominal 157 μ m K₈₀.
Copper Regrind Discharge - 28 μ m K₈₀

FLWSHEET: 2

Stage	Reagents Added g/tonne			Time (minutes)			pH
	Lime	PAX	MIBC	Grind	Cond.	Float	
Primary Grind	400			12			10.0
COPPER CIRCUIT:							
Rougher 1	340	1	15		1	2	10.5
Rougher 2	0	4	30		1	2	10.6
Regrind	250			8			10.3
Cleaner 1	1900	12	30		1	6	12.0
Cleaner 2	√	10	30		1	5	12.0
Cleaner 3	√	8	30		1	4	12.0

Grinding Data	Primary Grind	Copper Regrind
Mill:	M2-Mild	Stirred Mill
Charge/Material:	20kg-Mild	1.2kg-Beads
Water:	1000 ml	estimated

Flotation Data	Rougher	Cleaner
Flotation Machine	D2A	D1E
Cell Size in liters	4.4	2.2
Aspiration	Air	
Impeller Speed in rpm	1100	1200

KM2543-09 High Gold Copper Ratio East ZoneOverall Metallurgical Balance

Product	Weight		Assay - percent or g/t					Distribution - percent				
	grams	%	Cu	Fe	S	Ag	Au	Cu	Fe	S	Ag	Au
Cu Concentrate	158.7	8.0	32.9	29.3	32.4	47	49.4	89.9	37.0	66.3	66.0	78.4
Cu 3rd Cleaner Tail	5.8	0.3	6.90	17.2	14.3	39	36.7	0.7	0.8	1.1	2.0	2.1
Cu 2nd Cleaner Tail	25.9	1.3	1.10	11.9	7.63	10	8.56	0.5	2.5	2.5	2.4	2.2
Cu 1st Cleaner Tail	198.1	9.9	0.27	11.3	7.52	5	2.95	0.9	17.8	19.2	8.4	5.8
Cu Rougher Tail	1605.0	80.5	0.29	3.3	0.53	2	0.71	8.0	41.9	10.9	21.3	11.4
Feed	1993.5	100	2.91	6.3	3.89	6	5.01	100	100	100	100	100

KM2543-09 High Gold Copper Ratio East ZoneCumulative Metallurgical Balance

Cumulative Product	Cum. Weight		Assay - percent or g/t					Distribution - percent				
	grams	%	Cu	Fe	S	Ag	Au	Cu	Fe	S	Ag	Au
Product 1	158.7	8.0	32.9	29.3	32.4	47	49.4	89.9	37.0	66.3	66.0	78.4
Product 1 to 2	164.5	8.3	32.0	28.9	31.8	47	49.0	90.6	37.8	67.3	68.0	80.6
Product 1 to 3	190.4	9.6	27.8	26.6	28.5	42	43.5	91.1	40.3	69.9	70.3	82.8
Product 1 to 4	388.5	19.5	13.8	18.8	17.8	23	22.8	92.0	58.1	89.1	78.7	88.6
Product 5	1605.0	80.5	0.29	3.3	0.53	2	0.71	8.0	41.9	10.9	21.3	11.4
Feed	1993.5	100	2.91	6.3	3.89	6	5.01	100	100	100	100	100

PROJECT NO: KM2543-10

PURPOSE: To Repeat Test 4 using a High pH.

PROCEDURE: Perform a standard one product cleaner test with rougher at pH 10.5 and cleaner at pH 12.0.

FEED: 2 kg of High Bornite East Zone Composite ground to a nominal 154 μ m K₈₀.
Copper Regrind Discharge - 23 μ m K₈₀

FLWSHEET: 2

Stage	Reagents Added g/tonne			Time (minutes)			pH
	Lime	PAX	MIBC	Grind	Cond.	Float	
Primary Grind	500			17			9.9
COPPER CIRCUIT:							
Rougher 1	350	1	60		1	4	10.5
Rougher 2	0	1	60		1	4	10.5
Regrind	250			18			11.1
Cleaner 1	700	6	30		1	6	12.0
Cleaner 2	√	4	60		1	5	12.0
Cleaner 3	√	2	60		1	4	12.0

Grinding Data	Primary Grind	Copper Regrind
Mill:	M2-Mild	RM3-Mild
Charge/Material:	20kg - Mild	6kg-Mild
Water:	1000 ml	estimated

Flotation Data	Rougher	Cleaner
Flotation Machine	D2A	D1E
Cell Size in liters	4.4	2.2
Aspiration	Air	
Impeller Speed in rpm	1100	1200

KM2543-10 High Bornite East ZoneOverall Metallurgical Balance

Product	Weight		Assay - percent or g/t					Distribution - percent				
	grams	%	Cu	Fe	S	Ag	Au	Cu	Fe	S	Ag	Au
Cu Concentrate	52.6	2.7	50.0	17.1	26.4	212	59.6	90.0	9.3	82.8	78.9	74.0
Cu 3rd Cleaner Tail*	3.2	0.2	11.6	9.1	7.08	56	5.44	1.3	0.3	1.4	1.3	0.4
Cu 2nd Cleaner Tail	24.3	1.2	1.64	5.3	1.44	10	5.44	1.4	1.3	2.1	1.8	3.1
Cu 1st Cleaner Tail	142.3	7.2	0.37	4.7	0.59	3	1.36	1.8	7.0	5.0	3.1	4.6
Cu Rougher Tail	1762.5	88.8	0.09	4.5	0.08	1	0.43	5.6	82.0	8.8	15.0	17.9
Feed	1984.9	100	1.47	4.9	0.85	7	2.13	100	100	100	100	100

*Not enough sample for assay, Au values estimated.

KM2543-10 High Bornite East ZoneCumulative Metallurgical Balance

Cumulative Product	Cum. Weight		Assay - percent or g/t					Distribution - percent				
	grams	%	Cu	Fe	S	Ag	Au	Cu	Fe	S	Ag	Au
Product 1	52.6	2.7	50.0	17.1	26.4	212	59.6	90.0	9.3	82.8	78.9	74.0
Product 1 to 2	55.8	2.8	47.8	16.6	25.3	203	56.5	91.2	9.6	84.1	80.1	74.4
Product 1 to 3	80.1	4.0	33.8	13.2	18.1	145	41.0	92.6	11.0	86.2	81.9	77.5
Product 1 to 4	222.4	11.2	12.4	7.8	6.88	54	15.6	94.4	18.0	91.2	85.0	82.1
Product 5	1762.5	88.8	0.09	4.5	0.08	1	0.43	5.6	82.0	8.8	15.0	17.9
Feed	1984.9	100	1.47	4.9	0.85	7	2.13	100	100	100	100	100

PROJECT NO: KM2543-11

PURPOSE: To Investigate the Effect of a Secondary Collector for Gold.

PROCEDURE: Perform a standard one product cleaner test with rougher at pH 10.5 and cleaner at pH 12.0.

FEED: 2 kg of High Gold Copper Ratio East Zone Composite ground to a nominal 157 μ m K₈₀.
Copper Regrind Discharge - 29 μ m K₈₀

FLWSHEET: 2

Stage	Reagents Added g/tonne				Time (minutes)			pH
	Lime	PAX	3418A	MIBC	Grind	Cond.	Float	
Primary Grind	600				12			11.1
COPPER CIRCUIT:								
Rougher 1	-	1	1	15		1	2	10.6
Rougher 2	√	4	4	30		1	3	10.5
Regrind	1000				9			12.0
Cleaner 1	-	8	8	15		1	6	12.0
Cleaner 2	√	6	6	15		1	5	12.0
Cleaner 3	√	4	4	15		1	4	12.0

Grinding Data	Primary Grind	Copper Regrind
Mill:	M2-Mild	Stirred Mill
Charge/Material:	20kg-Mild	1.2kg-Beads
Water:	1000 ml	estimated

Flotation Data	Rougher	Cleaner
Flotation Machine	D2B	D1C
Cell Size in liters	4.4	2.2
Aspiration	Air	
Impeller Speed in rpm	1100	1200

KM2543-11 High Gold Copper Ratio East ZoneOverall Metallurgical Balance

Product	Weight		Assay - percent or g/t					Distribution - percent				
	grams	%	Cu	Fe	S	Ag	Au	Cu	Fe	S	Ag	Au
Cu Concentrate	179.7	9.0	32.6	27.9	33.3	56	51.9	96.7	40.6	76.8	80.7	87.3
Cu 3rd Cleaner Tail	9.9	0.5	2.33	16.7	13.5	18	6.65	0.4	1.3	1.7	1.4	0.6
Cu 2nd Cleaner Tail	34.7	1.7	0.41	12.8	7.89	6	2.23	0.2	3.6	3.5	1.7	0.7
Cu 1st Cleaner Tail	144.1	7.2	0.19	11.9	8.54	4	2.00	0.5	13.9	15.8	4.5	2.7
Cu Rougher Tail	1622.0	81.5	0.08	3.1	0.10	1	0.57	2.2	40.5	2.1	11.7	8.7
Feed	1990.4	100	3.04	6.2	3.91	6	5.37	100	100	100	100	100

KM2543-11 High Gold Copper Ratio East ZoneCumulative Metallurgical Balance

Cumulative Product	Cum. Weight		Assay - percent or g/t					Distribution - percent				
	grams	%	Cu	Fe	S	Ag	Au	Cu	Fe	S	Ag	Au
Product 1	179.7	9.0	32.6	27.9	33.3	56	51.9	96.7	40.6	76.8	80.7	87.3
Product 1 to 2	189.6	9.5	31.0	27.3	32.3	54	49.6	97.1	42.0	78.6	82.1	87.9
Product 1 to 3	224.3	11.3	26.3	25.1	28.5	47	42.3	97.3	45.6	82.1	83.8	88.6
Product 1 to 4	368.4	18.5	16.1	19.9	20.7	30	26.5	97.8	59.5	97.9	88.3	91.3
Product 5	1622.0	81.5	0.08	3.1	0.10	1	0.57	2.2	40.5	2.1	11.7	8.7
Feed	1990.4	100	3.04	6.2	3.91	6	5.37	100	100	100	100	100

PROJECT NO: KM2543-12

PURPOSE: To Investigate the Effect of a Secondary Collector for Gold.

PROCEDURE: Perform a standard one product cleaner test with rougher at pH 10.5 and cleaner at pH 12.0.

FEED: 2 kg of High Bornite East Zone Composite ground to a nominal 154 μ m K₈₀.
Copper Regrind Discharge - 23 μ m K₈₀

FLWSHEET: 2

Stage	Reagents Added g/tonne				Time (minutes)			pH
	Lime	PAX	3418A	MIBC	Grind	Cond.	Float	
Primary Grind	500				17			10.9
COPPER CIRCUIT:								
Rougher 1	-	1		60		1	4	10.5
Rougher 2	-	1	2	60		1	4	10.5
Regrind	600				18			11.7
Cleaner 1	500	4	4	60		1	6	12.0
Cleaner 2	√	3	3	60		1	5	12.0
Cleaner 3	√	1	1	60		1	4	12.0

Grinding Data	Primary Grind	Copper Regrind
Mill:	M2-Mild	RM3-Mild
Charge/Material:	20kg-Mild	6kg-Mild
Water:	1000 ml	estimated

Flotation Data	Rougher	Cleaner
Flotation Machine	D2B	D1C
Cell Size in liters	4.4	2.2
Aspiration	Air	
Impeller Speed in rpm	1100	1200

Note: Rougher 1 will over collect if more collector is added.

KM2543-12 High Bornite East ZoneOverall Metallurgical Balance

Product	Weight		Assay - percent or g/t					Distribution - percent				
	grams	%	Cu	Fe	S	Ag	Au	Cu	Fe	S	Ag	Au
Cu Concentrate	43.3	2.2	50.0	16.3	26.3	206	63.2	87.8	7.4	81.9	76.7	64.2
Cu 3rd Cleaner Tail	12.6	0.6	4.44	6.5	2.95	24	21.5	2.3	0.9	2.7	2.6	6.4
Cu 2nd Cleaner Tail	50.5	2.5	0.53	4.6	0.51	4	2.04	1.1	2.5	1.8	1.7	2.4
Cu 1st Cleaner Tail	122.9	6.2	0.24	4.6	0.27	2	2.16	1.2	5.9	2.4	2.3	6.2
Cu Rougher Tail	1762.3	88.5	0.11	4.5	0.09	1	0.50	7.6	83.4	11.1	16.7	20.8
Feed	1991.6	100	1.24	4.8	0.70	6	2.14	100	100	100	100	100

KM2543-12 High Bornite East ZoneCumulative Metallurgical Balance

Cumulative Product	Cum. Weight		Assay - percent or g/t					Distribution - percent				
	grams	%	Cu	Fe	S	Ag	Au	Cu	Fe	S	Ag	Au
Product 1	43.3	2.2	50.0	16.3	26.3	206	63.2	87.8	7.4	81.9	76.7	64.2
Product 1 to 2	55.9	2.8	39.7	14.1	21.0	165	53.8	90.1	8.2	84.6	79.3	70.6
Product 1 to 3	106.4	5.3	21.1	9.6	11.3	89	29.2	91.2	10.7	86.4	81.0	73.0
Product 1 to 4	229.3	11.5	9.93	6.9	5.39	42	14.7	92.4	16.6	88.9	83.3	79.2
Product 5	1762.3	88.5	0.11	4.5	0.09	1	0.50	7.6	83.4	11.1	16.7	20.8
Feed	1991.6	100	1.24	4.8	0.70	6	2.14	100	100	100	100	100

PROJECT NO: KM2543-13

PURPOSE: To Repeat Test 1 with More Collector and Time to Improve Recovery.

PROCEDURE: Perform a standard one product rougher test at a natural pH.

FEED: 2 kg of High Gold Copper Ratio East Zone Composite ground to a nominal 157 μ m K₈₀.

FLWSHEET: 1

Stage	Reagents Added g/tonne			Time (minutes)			pH
	PAX		MIBC	Grind	Cond.	Float	
Primary Grind				12			9.2
COPPER CIRCUIT:							
Rougher 1	6		60		1	3	9.2
Rougher 2	30		60		1	3	9.0
Rougher 3	30		60		1	3	9.0
Rougher 4	30		60		1	6	8.9

Flotation Data	Rougher	
Flotation Machine	D2B	
Cell Size in liters	4.4	
Aspiration		Air
Impeller Speed in rpm	1100	

Grinding Data	Primary Grind
Mill:	M2-Mild
Charge/Material:	20kg-Mild
Water:	1000 ml

KM2543-13 High Gold Copper Ratio East ZoneOverall Metallurgical Balance

Product	Weight		Assay - percent or g/t					Distribution - percent				
	grams	%	Cu	Fe	S	Ag	Au	Cu	Fe	S	Ag	Au
Cu Rougher 1	327.3	16.4	16.0	21.1	21.2	27	28.6	91.4	55.5	92.1	80.4	87.1
Cu Rougher 2	104.9	5.3	3.39	8.5	3.82	7	4.60	6.2	7.2	5.3	7.0	4.5
Cu Rougher 3	65.5	3.3	0.66	5.7	0.95	3	1.98	0.8	3.0	0.8	2.0	1.2
Cu Rougher 4	75.4	3.8	0.39	5.5	0.72	2	1.42	0.5	3.3	0.7	1.6	1.0
Cu Rougher Tail	1420.5	71.3	0.05	2.7	0.05	1	0.47	1.1	31.0	1.0	9.1	6.2
Feed	1993.6	100	2.87	6.2	3.78	6	5.39	100	100	100	100	100

KM2543-13 High Gold Copper Ratio East ZoneCumulative Metallurgical Balance

Cumulative Product	Cum. Weight		Assay - percent or g/t					Distribution - percent				
	grams	%	Cu	Fe	S	Ag	Au	Cu	Fe	S	Ag	Au
Product 1	327.3	16.4	16.0	21.1	21.2	27	28.6	91.4	55.5	92.1	80.4	87.1
Product 1 to 2	432.2	21.7	12.9	18.0	17.0	22	22.8	97.6	62.6	97.4	87.4	91.6
Product 1 to 3	497.7	25.0	11.3	16.4	14.9	20	20.0	98.3	65.6	98.2	89.4	92.8
Product 1 to 4	573.1	28.7	9.88	15.0	13.0	17	17.6	98.9	69.0	99.0	90.9	93.8
Product 5	1420.5	71.3	0.05	2.7	0.05	1	0.47	1.1	31.0	1.0	9.1	6.2
Feed	1993.6	100	2.87	6.2	3.78	6	5.39	100	100	100	100	100

PROJECT NO: KM2543-14

PURPOSE: To Repeat Test 2 with More Collector and Time to Improve Recovery.

PROCEDURE: Perform a standard one product rougher test at a natural pH.

FEED: 2 kg of High Bornite East Zone Composite ground to a nominal 154 μ m K₈₀.

FLWSHEET: 1

Stage	Reagents Added g/tonne			Time (minutes)			pH
	PAX		MIBC	Grind	Cond.	Float	
Primary Grind				17			9.2
COPPER CIRCUIT:							
Rougher 1	1		90		1	3	9.2
Rougher 2	30		60		1	3	9.3
Rougher 3	30		60		1	3	9.3
Rougher 4	30		60		1	6	9.3

Flotation Data	Rougher	
Flotation Machine	D2B	
Cell Size in liters	4.4	
Aspiration		Air
Impeller Speed in rpm	1100	

Grinding Data	Primary Grind
Mill:	M2-Mild
Charge/Material:	20kg-Mild
Water:	1000 ml

KM2543-14 High Bornite East ZoneOverall Metallurgical Balance

Product	Weight		Assay - percent or g/t					Distribution - percent				
	grams	%	Cu	Fe	S	Ag	Au	Cu	Fe	S	Ag	Au
Cu Rougher 1	111.5	5.7	19.4	10.0	11.4	82	23.7	79.1	11.4	73.2	72.7	61.7
Cu Rougher 2	107.8	5.5	3.49	5.4	2.18	16	7.47	13.8	6.0	13.5	13.3	18.8
Cu Rougher 3	79.6	4.0	0.73	4.4	0.47	4	2.27	2.1	3.6	2.1	2.3	4.2
Cu Rougher 4	93.9	4.8	0.37	4.1	0.25	2	1.45	1.3	3.9	1.4	1.8	3.2
Cu Rougher Tail	1575.9	80.0	0.06	4.6	0.11	1	0.33	3.7	75.0	9.8	10.0	12.1
Feed	1968.7	100	1.39	5.0	0.88	6	2.18	100	100	100	100	100

KM2543-14 High Bornite East ZoneCumulative Metallurgical Balance

Cumulative Product	Cum. Weight		Assay - percent or g/t					Distribution - percent				
	grams	%	Cu	Fe	S	Ag	Au	Cu	Fe	S	Ag	Au
Product 1	111.5	5.7	19.4	10.0	11.4	82	23.7	79.1	11.4	73.2	72.7	61.7
Product 1 to 2	219.3	11.1	11.6	7.8	6.87	50	15.7	92.9	17.5	86.7	86.0	80.5
Product 1 to 3	298.9	15.2	8.69	6.9	5.16	37	12.1	95.0	21.1	88.9	88.2	84.7
Product 1 to 4	392.8	20.0	6.70	6.2	3.99	29	9.59	96.3	25.0	90.2	90.0	87.9
Product 5	1575.9	80.0	0.06	4.6	0.11	1	0.33	3.7	75.0	9.8	10.0	12.1
Feed	1968.7	100	1.39	5.0	0.88	6	2.18	100	100	100	100	100

PROJECT NO: KM2543-15

PURPOSE: To Produce a Pan Concentrate for ADIS.

PROCEDURE: Perform a standard Knelson and panning technique.

FEED: 1.6 kg Test 1 Pyrite Rougher Tail Composite.

FLWSHEET NO: 1

Stage	Inlet Pressure	Outlet Pressures		Time Minutes
		Start	Finish	
Grind				n/a
KN Separation 1	65	1.0	1.2	5

KM2543-15 Test-01 Pyrite Rougher TailOverall Metallurgical Balance

Product	Weight		Assay - percent or g/t		Distribution - percent	
	grams	%	Au	Ag	Au	Ag
Pan Con	9.9	0.7	2.12	2.5	2.9	2.1
Pan Tl	46.3	3.2	0.91	1.2	5.8	4.7
Knelson Tl	1390.5	96.1	0.48	0.8	91.4	93.3
Feed	1446.7	100	0.50	0.8	100	100

KM2543-15 Test-01 Pyrite Rougher TailCumulative Metallurgical Balance

Cumulative Product	Cum. Weight		Assay - percent or g/t		Distribution - percent	
	grams	%	Au	Ag	Au	Ag
Product 1	9.9	0.7	2.12	2.5	2.9	2.1
Product 1 to 2	56.2	3.9	1.12	1.4	8.6	6.7
Product 3	1390.5	96.1	0.48	0.8	91.4	93.3
Feed	1446.7	100	0.50	0.8	100	100

PROJECT NO: KM2543-16

PURPOSE: To Produce a Pan Concentrate for ADIS.

PROCEDURE: Perform a standard Knelson and panning technique.

FEED: 1.6 kg Test 2 Pyrite Rougher Tail Composite.

FLWSHEET NO: 1

Stage	Inlet Pressure	Outlet Pressures		Time Minutes
		Start	Finish	
Grind				n/a
KN Separation 1	65	1.0	1.2	5

KM2543-16 Test-02 Pyrite Rougher TailOverall Metallurgical Balance

Product	Weight		Assay - percent or g/t		Distribution - percent	
	grams	%	Au	Ag	Au	Ag
Pan Con	8.4	0.7	1.60	2.1	3.6	1.5
Pan Tl	49.5	3.9	0.76	1.1	10.0	4.7
Knelson Tl	1209.0	95.4	0.27	0.9	86.5	93.8
Feed	1266.9	100	0.30	0.9	100	100

KM2543-16 Test-02 Pyrite Rougher TailCumulative Metallurgical Balance

Cumulative Product	Cum. Weight		Assay - percent or g/t		Distribution - percent	
	grams	%	Au	Ag	Au	Ag
Product 1	8.4	0.7	1.60	2.1	3.6	1.5
Product 1 to 2	57.9	4.6	0.88	1.2	13.5	6.2
Product 3	1209.0	95.4	0.27	0.9	86.5	93.8
Feed	1266.9	100	0.30	0.9	100	100

PROJECT NO: KM2543-17

PURPOSE: Preliminary Locked Cycle Test.

PROCEDURE: Perform a standard one product locked cycle test with rougher at pH 10.5 and cleaner at pH 12.0.

FEED: 5 x 2 kg of High Gold Copper Ratio East Zone Composite ground to a nominal 157 μ m K₈₀.
Copper Regrind Discharge - 22 μ m K₈₀

FLWSHEET: 3

Stage	Reagents Added g/tonne			Time (minutes)			pH
	Lime	PAX	MIBC	Grind	Cond.	Float	
Primary Grind	500			12			10.3
COPPER CIRCUIT:							
Rougher 1	200	1	15		1	4	10.5
Rougher 2	√	1	15		1	4	10.5
Scavenger 1	√	20	45		1	2	10.5
Scavenger 2	√	20	45		1	2	10.5
Regrind	1000			18			12.0
Cleaner 1	0	20	8		1	8	12.0
Cleaner 2	√	13	8		1	6	12.0
Cleaner 3	√	5	8		1	4	12.0

Grinding Data	Primary Grind	Copper Regrind
Mill:	M2-Mild	Stirred Mill
Charge/Material:	20kg-Mild	1.2kg-Beads
Water:	1000 ml	estimated

Flotation Data	Rougher	Cleaner
Flotation Machine	D2B	D1C
Cell Size in liters	4.4	2.2
Aspiration	Air	
Impeller Speed in rpm	1100	1200

KM2543-17
Estimated Dry Weight Table

Product	Cycles - Weight (gms)				
	I	II	III	IV	V
<u>COPPER CIRCUIT</u>					
Rougher Concentrate	420	400	415	395	415
Cleaner Tail 1	200	265	260	315	265
Cleaner Tail 2	85	91	145	110	130
Cleaner Tail 3	38	51	71	63	54
Copper Concentrate	175	185	195	190	195
Primary Discharge pH	9.0	10.3	10.3	10.4	10.5

KM2543-17 High Gold Copper Ratio East Zone
OVERALL CYCLE TEST MASS AND METAL BALANCE

Product	Weight g	Weight %	Assay - percent or g/t					Distribution - percent				
			Cu	Fe	S	Ag	Au	Cu	Fe	S	Ag	Au
Copper Con I	178.2	1.8	31.9	27.5	32.5	53	55.6	19.0	7.7	15.3	15.9	18.1
Copper Con II	195.2	1.9	29.8	26.6	31.1	50	48.8	19.4	8.2	16.0	16.4	17.3
Copper Con III	201.2	2.0	29.5	27.0	31.6	51	50.5	19.8	8.5	16.8	17.4	18.5
Copper Con IV	199.4	2.0	29.5	30.1	33.5	51	49.0	19.7	9.4	17.6	17.1	17.8
Copper Con V	212.1	2.1	27.5	31.2	33.4	49	44.5	19.5	10.4	18.7	17.7	17.2
Copper 3rd Clnr Tail	45.3	0.5	0.54	19.0	16.1	11	3.31	0.1	1.4	1.9	0.8	0.3
Copper 2nd Clnr Tail	106.4	1.1	0.16	8.3	2.46	4	0.99	0.1	1.4	0.7	0.7	0.2
Copper 1st Clnr Tail	177.3	1.8	0.13	8.5	3.93	3	2.11	0.1	2.4	1.8	0.8	0.7
Copper 1st Clnr Tail	235.7	2.4	0.10	8.9	2.67	2	1.65	0.1	3.3	1.7	0.9	0.7
Copper 1st Clnr Tail	228.9	2.3	0.10	9.7	4.97	3	1.20	0.1	3.5	3.0	1.0	0.5
Copper 1st Clnr Tail	262.5	2.6	0.11	8.7	3.54	3	1.43	0.1	3.6	2.4	1.2	0.7
Copper 1st Clnr Tail	220.3	2.2	0.10	8.7	2.64	3	1.25	0.1	3.0	1.5	1.1	0.5
Copper Ro Tail I	1544.0	15.4	0.16	3.3	0.22	1	0.59	0.8	8.0	0.9	2.1	1.7
Copper Ro Tail II	1537.8	15.4	0.06	3.2	0.11	1	0.55	0.3	7.8	0.5	1.8	1.5
Copper Ro Tail III	1526.8	15.3	0.05	3.0	0.11	1	0.52	0.3	7.2	0.5	1.8	1.4
Copper Ro Tail IV	1577.0	15.8	0.07	2.9	0.12	1	0.50	0.3	7.1	0.5	1.6	1.4
Copper Ro Tail V	1563.0	15.6	0.06	2.9	0.08	1	0.52	0.3	7.2	0.3	1.6	1.5
FEED	10011	100	2.99	6.4	3.79	6	5.49	100	100	100	100	100

KM2543-17 High Gold Copper Ratio East Zone
METALLURGICAL BALANCES BY TEST CYCLES

Product	Weight g	Weight %	Assay - percent or g/t					Distribution - percent				
			Cu	Fe	S	Ag	Au	Cu	Fe	S	Ag	Au
CYCLE IV												
Flotation Feed	2038.9	100	2.95	6.3	3.82	6	5.36	100	100	100	100	100
Copper Con	199.4	9.8	29.5	30.1	33.5	51	49.0	97.8	46.8	85.7	86.0	89.4
Copper 1st Clnr Tail	262.5	12.9	0.11	8.7	3.54	3	1.43	0.5	17.8	11.9	6.0	3.4
Copper Ro Tail	1577.0	77.3	0.07	2.9	0.12	1	0.50	1.7	35.4	2.3	8.0	7.2
CYCLE V												
Flotation Feed	1995.4	100	2.98	6.6	3.90	6	5.28	100	100	100	100	100
Copper Con	212.1	10.6	27.5	31.2	33.4	49	44.5	98.0	50.5	91.0	86.7	89.6
Copper 1st Clnr Tail	220.3	11.0	0.10	8.7	2.64	3	1.25	0.4	14.6	7.5	5.5	2.6
Copper Ro Tail	1563.0	78.3	0.06	2.9	0.08	1	0.52	1.7	34.8	1.5	7.8	7.7
CYCLES IV and V												
Flotation Feed	4034.3	100	2.97	6.4	3.86	6	5.32	100	100	100	100	100
Copper Con	411.5	10.2	28.5	30.7	33.4	50	46.7	97.9	48.7	88.4	86.3	89.5
Copper 1st Clnr Tail	482.8	12.0	0.11	8.7	3.12	3	1.35	0.4	16.2	9.7	5.7	3.0
Copper Ro Tail	3140.0	77.8	0.06	2.9	0.10	1	0.51	1.7	35.1	1.9	7.9	7.5

Cycle Test Stability Data

Cycles	Mass		Calculated Head - percent or g/t					Metal Unit Variances (%)				
	g/cycle	%Var.	Cu	Fe	S	Ag	Au	Cu	Fe	S	Ag	Au
I	1899.5	-5.13	3.13	6.1	3.60	6	5.90	-1	-9	-10	-6	2
II	1968.7	-1.67	3.01	6.2	3.49	6	5.46	-1	-4	-9	-5	-2
III	1956.9	-2.26	3.08	6.3	3.92	6	5.74	1	-4	1	1	2
IV	2038.9	1.83	2.95	6.3	3.82	6	5.36	0	1	3	0	0
V	1995.4	-0.34	2.98	6.6	3.90	6	5.28	-1	3	3	2	-4
Total	2002.2	-	2.99	6.4	3.79	6	5.49	-	-	-	-	-

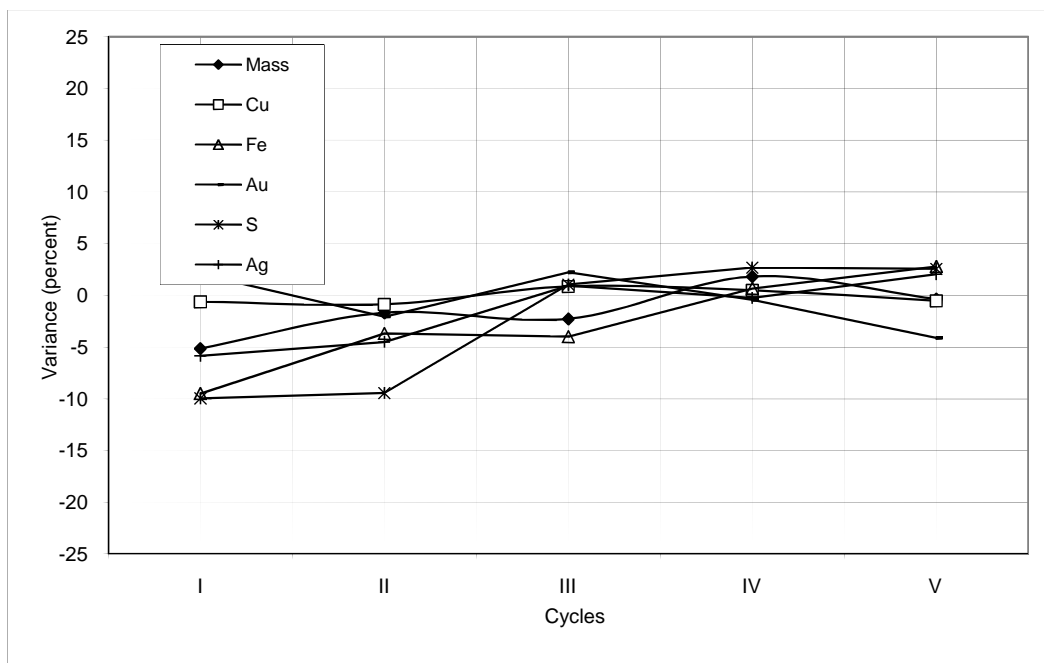

KM2543-17 High Gold Copper Ratio East Zone
CYCLES (IV+V) MASS BALANCE FLOWSHEET AND METALLURGICAL BALANCE DATA

Flotation Stream		Weight %	Assay - percent or g/t					Distribution - percent				
No.	Product		Cu	Fe	S	Ag	Au	Cu	Fe	S	Ag	Au
1	Copper Ro Feed	100.0	2.97	6.4	3.86	6	5.32	100.0	100.0	100.0	100.0	100.0
2	Copper Ro Tail	77.8	0.06	2.9	0.10	1	0.51	1.7	35.1	1.9	7.9	7.5
3	Copper Ro Con	22.2	13.2	18.8	17.1	25	22.2	98.3	64.9	98.1	92.1	92.5
4	Copper 1st Clnr Feed	29.8	9.87	16.9	14.4	20	17.0	99.0	78.5	110.9	99.7	94.9
5	Copper 1st Clnr Tail	12.0	0.11	8.7	3.12	3	1.35	0.4	16.2	9.7	5.7	3.0
6	Copper 1st Clnr Con	17.8	16.4	22.5	22.0	31	27.5	98.6	62.3	101.3	94.0	91.9
7	Copper 2nd Clnr Tail	5.3	0.16	8.3	2.46	4	0.99	0.3	6.9	3.4	3.4	1.0
8	Copper 2nd Clnr Con	12.5	23.4	28.5	30.3	43	38.8	98.3	55.4	97.9	90.5	90.9
9	Copper 3rd Clnr Tail	2.3	0.54	19.0	16.1	11	3.31	0.4	6.7	9.5	4.2	1.4
10	Copper 3rd Clnr Con	10.2	28.5	30.7	33.4	50	46.7	97.9	48.7	88.4	86.3	89.5
11	Final Tail	89.8	0.07	3.7	0.50	1	0.62	2.1	51.3	11.6	13.7	10.5

PROJECT NO: KM2543-18

PURPOSE: Preliminary Locked Cycle Test.

PROCEDURE: Perform a standard one product locked cycle test with rougher at pH 10.5 and cleaner at pH 12.0.

FEED: 5 x 2 kg of High Bornite East Zone Composite ground to a nominal 154 μ m K₈₀.
Copper Regrind Discharge - 25 μ m K₈₀

FLWSHEET: 3

Stage	Reagents Added g/tonne				Time (minutes)			pH
	Lime	PAX	W34	MIBC	Grind	Cond.	Float	
Primary Grind	500				17			10.0
COPPER CIRCUIT:								
Rougher 1	250	1		45		1	4	10.5
Rougher 2	√	1		30		1	4	10.5
Scavenger 1	√	20		30		1	2	10.5
Scavenger 2	√	20		30		1	2	10.5
Regrind	1000				17			11.8
Cleaner 1	500	15	28			1	6	12.0
Cleaner 2	√	10	28			1	5	12.0
Cleaner 3	√	5	14			1	4	12.0

Grinding Data	Primary Grind	Copper Regrind
Mill:	M2-Mild	RM3-Mild
Charge/Material:	20kg-Mild	6kg-Mild
Water:	1000 ml	estimated

Flotation Data	Rougher	Cleaner
Flotation Machine	D2B	D1C
Cell Size in liters	4.4	2.2
Aspiration	Air	
Impeller Speed in rpm	1100	1200

KM2543-18
Estimated Dry Weight Table

Product	Cycles - Weight (gms)				
	I	II	III	IV	V
<u>COPPER CIRCUIT</u>					
Rougher Concentrate	240	240	237	235	243
Cleaner Tail 1	135	185	250	230	228
Cleaner Tail 2	81	110	89	110	110
Cleaner Tail 3	31	36	40	28	45
Copper Concentrate	51	56	58	55	58
Primary Discharge pH	9.8	10.0	10.3	10.1	10.0

KM2543-18 High Bornite East Zone
OVERALL CYCLE TEST MASS AND METAL BALANCE

Product	Weight g	Weight %	Assay - percent or g/t					Distribution - percent				
			Cu	Fe	S	Ag	Au	Cu	Fe	S	Ag	Au
Copper Con I	50.6	0.5	49.8	16.9	25.6	202	71.3	17.6	1.8	16.1	14.6	16.1
Copper Con II	55.2	0.6	49.0	16.9	25.2	210	66.1	18.8	2.0	17.3	16.5	16.3
Copper Con III	56.9	0.6	48.2	16.8	24.4	198	69.3	19.1	2.0	17.3	16.0	17.6
Copper Con IV	53.0	0.5	49.2	17.0	25.4	208	73.4	18.2	1.9	16.7	15.7	17.3
Copper Con V	55.4	0.6	48.5	17.1	25.4	206	64.2	18.7	2.0	17.5	16.3	15.8
Copper 3rd Clnr Tail	30.7	0.3	3.03	6.3	2.02	14	3.79	0.6	0.4	0.8	0.6	0.5
Copper 2nd Clnr Tail	85.5	0.9	0.45	4.1	0.34	4	1.92	0.3	0.7	0.4	0.5	0.7
Copper 1st Clnr Tail	103.8	1.0	0.22	4.4	0.31	3	1.94	0.2	1.0	0.4	0.4	0.9
Copper 1st Clnr Tail	139.9	1.4	0.27	4.2	0.30	3	0.98	0.3	1.3	0.5	0.7	0.6
Copper 1st Clnr Tail	187.0	1.9	0.40	4.1	0.36	4	1.29	0.5	1.6	0.8	1.0	1.1
Copper 1st Clnr Tail	165.1	1.7	0.34	4.2	0.34	3	1.27	0.4	1.4	0.7	0.8	0.9
Copper 1st Clnr Tail	162.4	1.6	0.33	4.1	0.29	3	0.78	0.4	1.4	0.6	0.7	0.6
Copper Ro Tail I	1764.1	17.7	0.08	4.4	0.10	1	0.32	1.0	16.6	2.1	3.3	2.5
Copper Ro Tail II	1767.5	17.8	0.08	4.4	0.10	1	0.29	1.0	16.3	2.2	3.3	2.3
Copper Ro Tail III	1760.5	17.7	0.08	4.5	0.10	1	0.32	0.9	16.7	2.1	3.3	2.5
Copper Ro Tail IV	1768.3	17.8	0.09	4.4	0.11	1	0.29	1.0	16.5	2.4	3.3	2.3
Copper Ro Tail V	1748.1	17.6	0.09	4.4	0.10	1	0.26	1.1	16.4	2.2	3.2	2.0
FEED	9954	100	1.44	4.7	0.81	7	2.26	100	100	100	100	100

KM2543-18 High Bornite East Zone
METALLURGICAL BALANCES BY TEST CYCLES

Product	Weight g	Weight %	Assay - percent or g/t					Distribution - percent				
			Cu	Fe	S	Ag	Au	Cu	Fe	S	Ag	Au
CYCLE IV												
Flotation Feed	1986.4	100	1.42	4.7	0.80	7	2.32	100	100	100	100	100
Copper Con	53.0	2.7	49.2	17.0	25.4	208	73.4	92.7	9.6	84.2	79.4	84.3
Copper 1st Clnr Tail	165.1	8.3	0.34	4.2	0.34	3	1.27	2.0	7.3	3.5	4.0	4.5
Copper Ro Tail	1768.3	89.0	0.09	4.4	0.11	1	0.29	5.3	83.1	12.3	16.6	11.2
CYCLE V												
Flotation Feed	1965.9	100	1.47	4.8	0.83	7	2.11	100	100	100	100	100
Copper Con	55.4	2.8	48.5	17.1	25.4	206	64.2	92.9	10.1	86.4	80.5	85.9
Copper 1st Clnr Tail	162.4	8.3	0.33	4.1	0.29	3	0.78	1.9	7.1	2.9	3.4	3.1
Copper Ro Tail	1748.1	88.9	0.09	4.4	0.10	1	0.26	5.3	82.8	10.7	16.0	11.0
CYCLES IV and V												
Flotation Feed	3952.3	100	1.44	4.7	0.82	7	2.22	100	100	100	100	100
Copper Con	108.4	2.7	48.8	17.1	25.4	207	68.7	92.8	9.9	85.3	80.0	85.1
Copper 1st Clnr Tail	327.5	8.3	0.34	4.1	0.32	3	1.03	1.9	7.2	3.2	3.7	3.8
Copper Ro Tail	3516.4	89.0	0.09	4.4	0.11	1	0.28	5.3	82.9	11.5	16.3	11.1

Cycle Test Stability Data

Cycles	Mass		Calculated Head - percent or g/t					Metal Unit Variances (%)				
	g/cycle	%Var.	Cu	Fe	S	Ag	Au	Cu	Fe	S	Ag	Au
I	1918.5	-3.63	1.40	4.8	0.78	7	2.28	-6	-3	-7	-9	-3
II	1962.6	-1.42	1.47	4.7	0.82	7	2.19	0	-2	0	2	-4
III	2004.4	0.68	1.47	4.8	0.81	7	2.37	3	2	1	1	6
IV	1986.4	-0.22	1.42	4.7	0.80	7	2.32	-2	-1	-1	-1	3
V	1965.9	-1.25	1.47	4.8	0.83	7	2.11	1	-1	1	1	-8
Total	1990.8	-	1.44	4.7	0.81	7	2.26	-	-	-	-	-

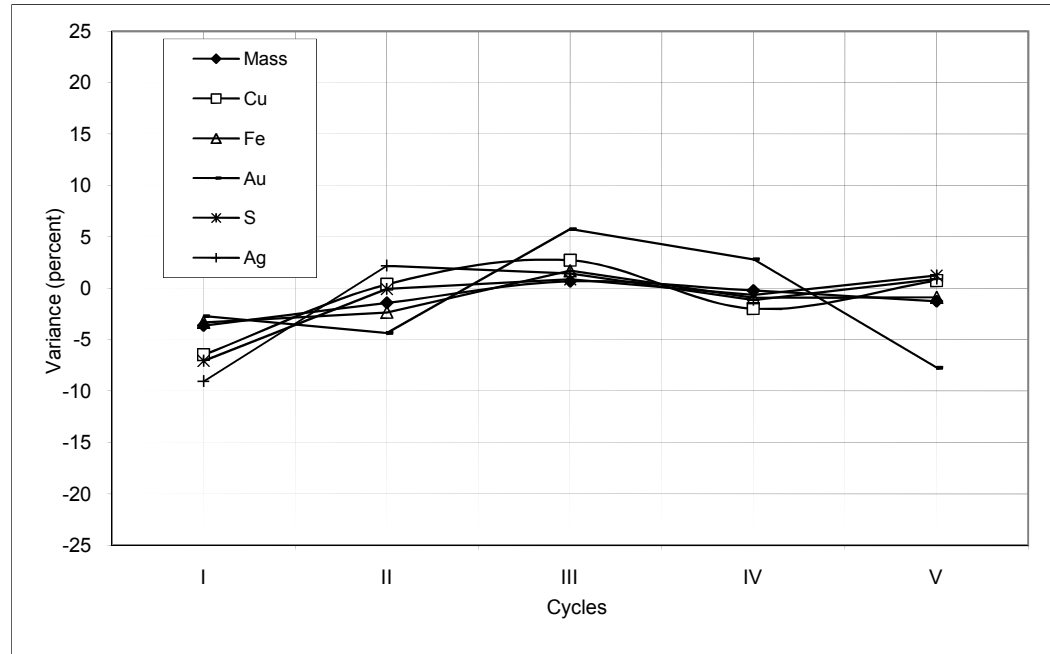

KM2543-18 High Bornite East Zone

CYCLES (IV+V) MASS BALANCE FLOWSHEET AND METALLURGICAL BALANCE DATA

Flotation Stream		Weight %	Assay - percent or g/t					Distribution - percent				
No.	Product		Cu	Fe	S	Ag	Au	Cu	Fe	S	Ag	Au
1	Copper Ro Feed	100.0	1.44	4.7	0.82	7	2.22	100.0	100.0	100.0	100.0	100.0
2	Copper Ro Tail	89.0	0.09	4.4	0.11	1	0.28	5.3	82.9	11.5	16.3	11.1
3	Copper Ro Con	11.0	12.4	7.3	6.55	54	17.9	94.7	17.1	88.5	83.7	88.9
4	Copper 1st Clnr Feed	16.9	8.47	6.4	4.54	37	12.5	99.3	22.9	94.2	89.4	95.3
5	Copper 1st Clnr Tail	8.3	0.34	4.1	0.32	3	1.03	1.9	7.2	3.2	3.7	3.8
6	Copper 1st Clnr Con	8.7	16.3	8.6	8.58	70	23.4	97.4	15.7	91.0	85.7	91.5
7	Copper 2nd Clnr Tail	4.3	0.45	4.1	0.34	4	1.92	1.4	3.8	1.8	2.5	3.8
8	Copper 2nd Clnr Con	4.3	32.2	13.2	16.9	137	45.2	96.1	11.9	89.2	83.1	87.7
9	Copper 3rd Clnr Tail	1.6	3.03	6.3	2.02	14	3.79	3.3	2.1	3.9	3.2	2.7
10	Copper 3rd Clnr Con	2.7	48.8	17.1	25.4	207	68.7	92.8	9.9	85.3	80.0	85.1
11	Final Tail	97.3	0.11	4.4	0.12	1	0.34	7.2	90.1	14.7	20.0	14.9

PROJECT NO: KM2543-19
PURPOSE: To Recover Gold from Test 17 Copper First Cleaner Tail I-V.
PROCEDURE: Perform a standard Knelson and panning technique.
FEED: Test 17 Copper First Cleaner Tail I-V.
FLWSHEET NO: 1

Stage	Inlet Pressure	Outlet Pressures		Time Minutes
		Start	Finish	
Grind				n/a
KN Separation 1	65	2.0	2.2	5

KM2543-19 Test 17 Copper First Cleaner Tail I-V
Overall Metallurgical Balance

Product	Weight		Assay - percent or g/t	Distribution - percent
	grams	%	Au	Au
Pan Con	9.2	0.9	56.7	35.4
Pan Tail	33.2	3.4	7.32	16.5
Knelson Tail	940.2	95.7	0.75	48.1
Feed	982.6	100	1.50	100

KM2543-19 Test 17 Copper First Cleaner Tail I-V
Cumulative Metallurgical Balance

Cumulative Product	Cum. Weight		Assay - percent or g/t	Distribution - percent
	grams	%	Au	Au
Product 1	9.2	0.9	56.7	35.4
Product 1 to 2	42.4	4.3	18.0	51.9
Product 3	940.2	95.7	0.75	48.1
Feed	982.6	100.0	1.50	100

APPENDIX III – KM2543

PARTICLE SIZING DATA

INDEX

<u>TABLE</u>		<u>µm K₈₀</u>	<u>PAGE</u>
<u>ABRASION TESTS</u>			
III-1	KM2543 High Gold Copper Ratio East Zone	-	1
III-2	KM2543 High Bornite East Zone	-	3
<u>ROD MILL</u>			
III-3	KM2543 High Gold Copper Ratio East Zone	-	5
III-4	KM2543 High Bornite East Zone	-	10
<u>BALL MILL</u>			
III-5	KM2543 High Gold Copper Ratio East Zone	-	15
III-6	KM2543 High Bornite East Zone	-	20
<u>GRIND CALIBRATIONS</u>			
III-7	KM2543 High Gold Copper Ratio East Zone-10 Minute Grind	190	25
III-8	KM2543 High Bornite East Zone-12 Minute Grind	266	26
III-9	KM2543 High Bornite East Zone-15 Minute Grind	174	27
<u>MODALS</u>			
III-10	KM2543 High Gold Copper Ratio East Zone-12 Minute Grind	157	28
III-11	KM2543 High Bornite East Zone-17 Minute Grind	154	29
<u>LASER SIZINGS</u>			
III-12	KM2543-03 Copper Re grind Discharge	36	30
III-13	KM2543-04 Copper Re grind Discharge	26	31
III-14	KM2543-07 Copper Re grind Discharge	26	32
III-15	KM2543-08 Copper Re grind Discharge	36	33
III-16	KM2543-09 Copper Re grind Discharge	28	34
III-17	KM2543-10 Copper Re grind Discharge	23	35
III-18	KM2543-11 Copper Re grind Discharge	29	36

III-19	KM2543-12 Copper Regrind Discharge	23	37
III-20	KM2543-17 Copper Regrind Discharge	22	38
III-21	KM2543-18 Copper Regrind Discharge	25	39

TABLE III-1A
BOND ABRASION TEST
KM2543 High Gold Copper Ratio East Zone

Original Paddle Weight: 95.4024 g

Final Paddle Weight: 94.9507 g

Abrasion Index, A_i : 0.4517

Wear Material	Wear Equation	Predicted Wear Rates	
		lb/kwh	kg/kwh
Wet rod mill, rods	$0.35*(A_i-0.020)^{0.20}$	0.296	0.134
Wet rod mill, liners	$0.35*(A_i-0.015)^{0.30}$	0.027	0.012
Wet ball mill, balls	$0.35*(A_i-0.015)^{0.33}$	0.027	0.0121
Wet ball mill, liners	$0.026*(A_i-0.015)^{0.30}$	0.020	0.0092
Dry ball mill, balls	$0.05*(A_i)^{0.5}$	0.034	0.015
Dry ball mill, liners	$0.005*(A_i)^{0.5}$	0.0034	0.0015
Crusher, liners	$(A_i+0.22)/11$	0.061	0.028
Roll Crusher, shells	$(A_i/10)^{0.67}$	0.126	0.057

Total Feed Weight 1578 g

P = 80% Passing size of test product 10518 μ m

TABLE III-1B
BOND ABRASION SCREEN ANALYSIS
KM2543 High Gold Copper Ratio East Zone

Product	Particle Size μm	Weight % Retained	Cumulative % Passing
5/8 Mesh	16000	0.00	100.0
1/2 Mesh	12500	6.64	93.4
7/16 Mesh	11200	9.49	83.9
3/8 Mesh	9500	9.76	74.1
3 Mesh	6300	18.07	56.0
4 Mesh	4750	7.11	48.9
6 Mesh	3360	7.20	41.7
TOTAL		100.00	**

K80 = 10518 μm

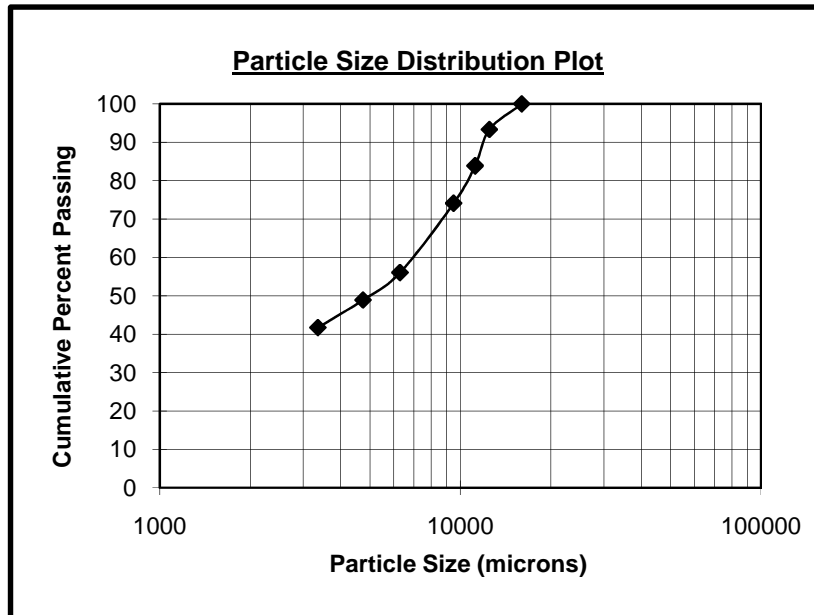

TABLE III-2A
BOND ABRASION TEST
KM2543 High Bornite East Zone

Original Paddle Weight: 95.7171 g

Final Paddle Weight: 95.4024 g

Abrasion Index, A_i : 0.3147

Wear Material	Wear Equation	Predicted Wear Rates	
		lb/kwh	kg/kwh
Wet rod mill, rods	$0.35*(A_i-0.020)^{0.20}$	0.274	0.124
Wet rod mill, liners	$0.35*(A_i-0.015)^{0.30}$	0.024	0.011
Wet ball mill, balls	$0.35*(A_i-0.015)^{0.33}$	0.024	0.0107
Wet ball mill, liners	$0.026*(A_i-0.015)^{0.30}$	0.018	0.0082
Dry ball mill, balls	$0.05*(A_i)^{0.5}$	0.028	0.013
Dry ball mill, liners	$0.005*(A_i)^{0.5}$	0.0028	0.0013
Crusher, liners	$(A_i+0.22)/11$	0.049	0.022
Roll Crusher, shells	$(A_i/10)^{0.67}$	0.099	0.045

Total Feed Weight 1566 g

P = 80% Passing size of test product 11995 μm

TABLE III-2B
BOND ABRASION SCREEN ANALYSIS
KM2543 High Bornite East Zone

Product	Particle Size μm	Weight % Retained	Cumulative % Passing
3/4 Mesh	18845	0.00	100.0
5/8 Mesh	16000	0.68	99.3
1/2 Mesh	12500	14.50	84.8
7/16 Mesh	11200	12.23	72.6
3/8 Mesh	9500	10.72	61.9
3 Mesh	6300	14.68	47.2
4 Mesh	4750	5.21	42.0
6 Mesh	3360	4.30	37.7
TOTAL		100.00	**

K80 = 11995 μm

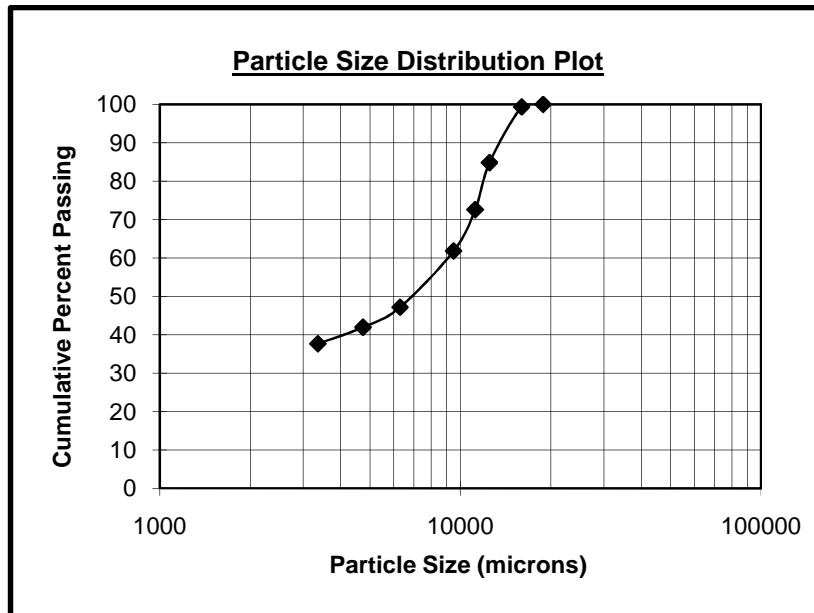

TABLE III-3B
ROD MILL SCREEN ANALYSIS
KM2543 High Gold Copper Ratio East Zone Cycle 6 Undersize

Product	Particle Size µm	Weight % Retained	Cumulative % Passing
14 Mesh	1180	3.47	96.5
16 Mesh	1000	10.26	86.3
20 Mesh	850	9.27	77.0
28 Mesh	600	14.72	62.3
35 Mesh	425	10.52	51.8
48 Mesh	300	8.70	43.1
65 Mesh	212	7.62	35.4
TOTAL		107.62	**

K80 = 898µm

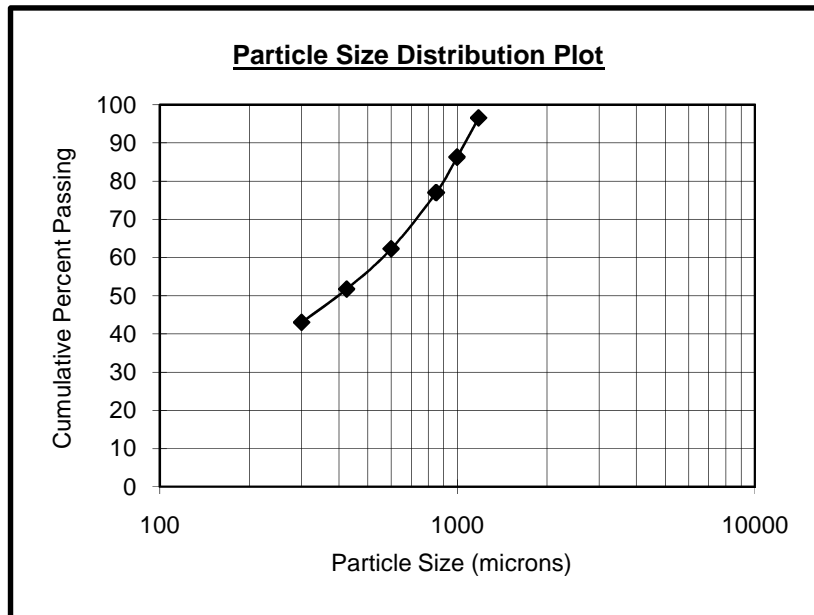

TABLE III-3C
ROD MILL SCREEN ANALYSIS
KM2543 High Gold Copper Ratio East Zone Average Feed

Product	Particle Size µm	Weight % Retained	Cumulative % Passing
1/2 Mesh	12700	0.00	100.0
7/16 Mesh	11200	8.44	91.6
3/8 Mesh	9510	19.21	72.4
3 Mesh	6700	26.50	45.9
4 Mesh	4760	10.96	34.9
6 Mesh	3360	9.50	25.4
8 Mesh	2360	5.97	19.4
10 Mesh	1700	3.52	15.9
14 Mesh	1180	2.92	13.0
TOTAL		100.00	**

K80 =10198µm

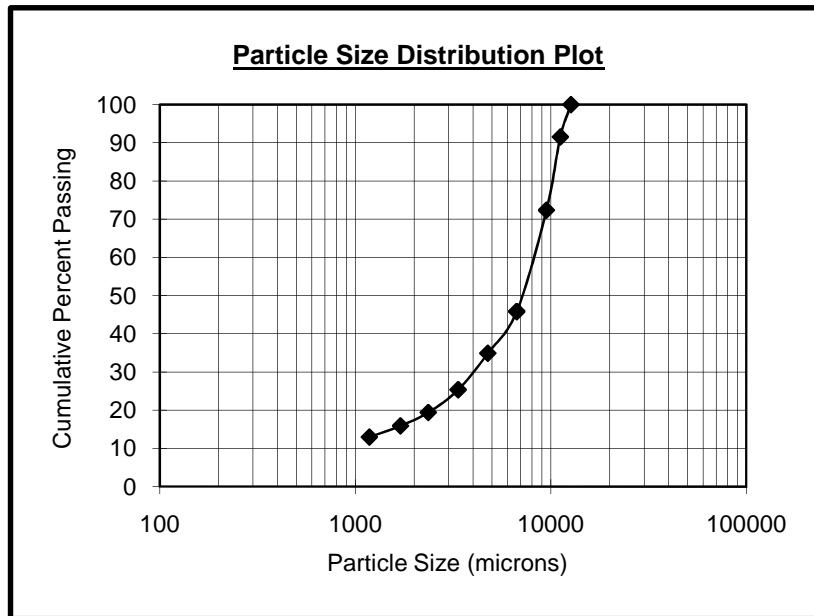

TABLE III-3D
ROD MILL SCREEN ANALYSIS
KM2543 High Gold Copper Ratio East Zone Feed 1

Product	Particle Size µm	Weight % Retained	Cumulative % Passing
1/2 Mesh	12700	0.00	100.0
7/16 Mesh	11200	8.09	91.9
3/8 Mesh	9510	19.46	72.5
3 Mesh	6700	26.81	45.6
4 Mesh	4760	10.83	34.8
6 Mesh	3360	9.37	25.4
8 Mesh	2360	6.11	19.3
10 Mesh	1700	3.51	15.8
14 Mesh	1180	2.88	12.9
TOTAL		100.00	**

K80 =10181µm

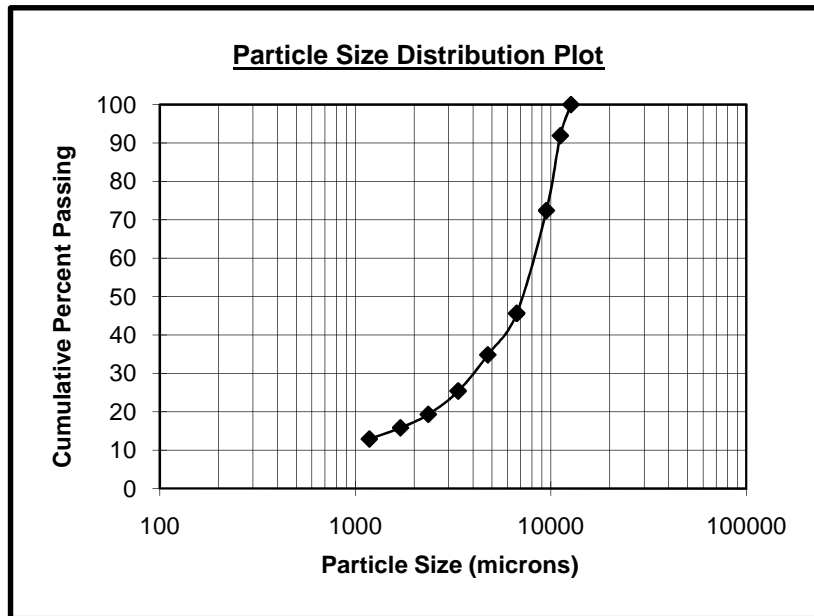

TABLE III-3E
ROD MILL SCREEN ANALYSIS
KM2543 High Gold Copper Ratio East Zone Feed 2

Product	Particle Size µm	Weight % Retained	Cumulative % Passing
1/2 Mesh	12700	0.00	100.0
7/16 Mesh	11200	8.78	91.2
3/8 Mesh	9510	18.97	72.3
3 Mesh	6700	26.19	46.1
4 Mesh	4760	11.09	35.0
6 Mesh	3360	9.62	25.4
8 Mesh	2360	5.83	19.5
10 Mesh	1700	3.53	16.0
14 Mesh	1180	2.96	13.0
TOTAL		100.00	**

K80 =10215µm

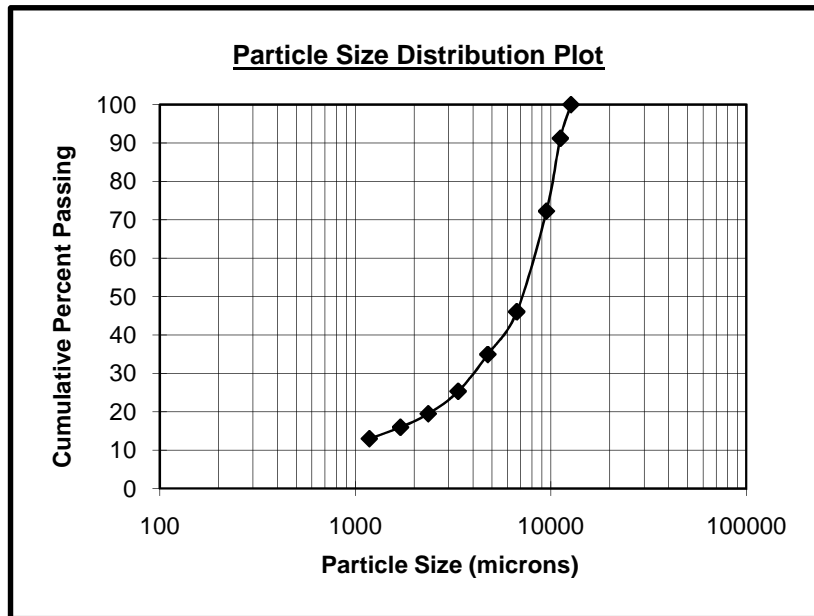

TABLE III-4B
ROD MILL SCREEN ANALYSIS
KM2543 High Bornite East Zone Cycle 6 Undersize

Product	Particle Size µm	Weight % Retained	Cumulative % Passing
14 Mesh	1180	3.49	96.5
16 Mesh	1000	12.47	84.0
20 Mesh	850	10.79	73.3
28 Mesh	600	16.82	56.4
35 Mesh	425	11.99	44.4
48 Mesh	300	9.19	35.2
65 Mesh	212	7.03	28.2
TOTAL		107.03	**

K80 =943µm

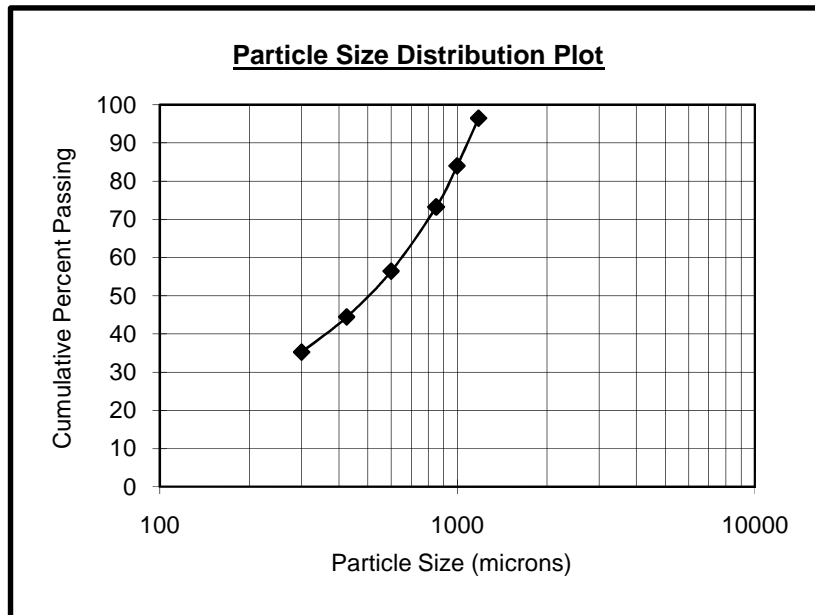

TABLE III-4C
ROD MILL SCREEN ANALYSIS
KM2543 High Bornite East Zone Average Feed

Product	Particle Size µm	Weight % Retained	Cumulative % Passing
1/2 Mesh	12700	0.00	100.0
7/16 Mesh	11200	11.01	89.0
3/8 Mesh	9510	20.44	68.5
3 Mesh	6700	29.16	39.4
4 Mesh	4760	10.50	28.9
6 Mesh	3360	7.89	21.0
8 Mesh	2360	5.09	15.9
10 Mesh	1700	2.95	12.9
14 Mesh	1180	2.70	10.2
TOTAL		100.00	**

K80 =10477µm

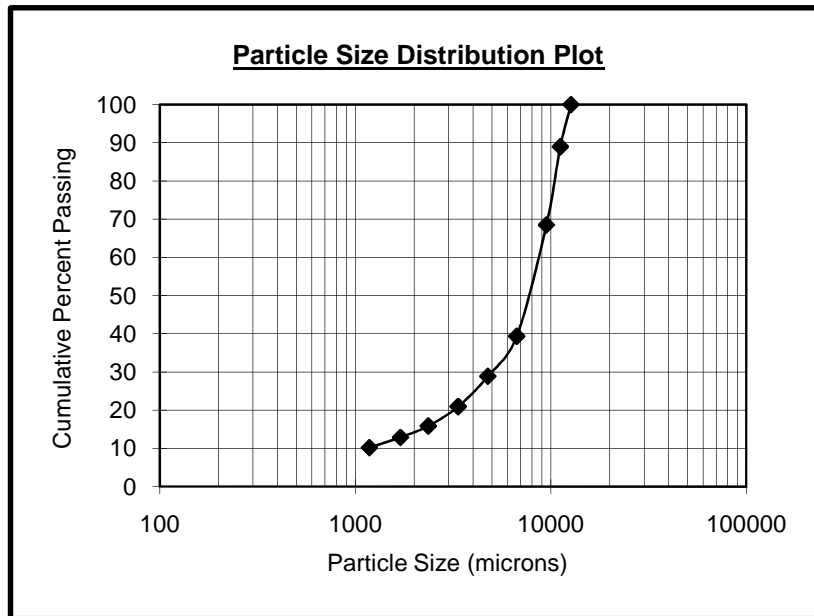

TABLE III-4D
ROD MILL SCREEN ANALYSIS
KM2543 High Bornite East Zone Feed 1

Product	Particle Size µm	Weight % Retained	Cumulative % Passing
1/2 Mesh	12700	0.00	100.0
7/16 Mesh	11200	10.60	89.4
3/8 Mesh	9510	21.60	67.8
3 Mesh	6700	28.78	39.0
4 Mesh	4760	10.59	28.4
6 Mesh	3360	7.85	20.6
8 Mesh	2360	4.66	15.9
10 Mesh	1700	2.83	13.1
14 Mesh	1180	2.65	10.4
TOTAL		100.00	**

K80 =10488µm

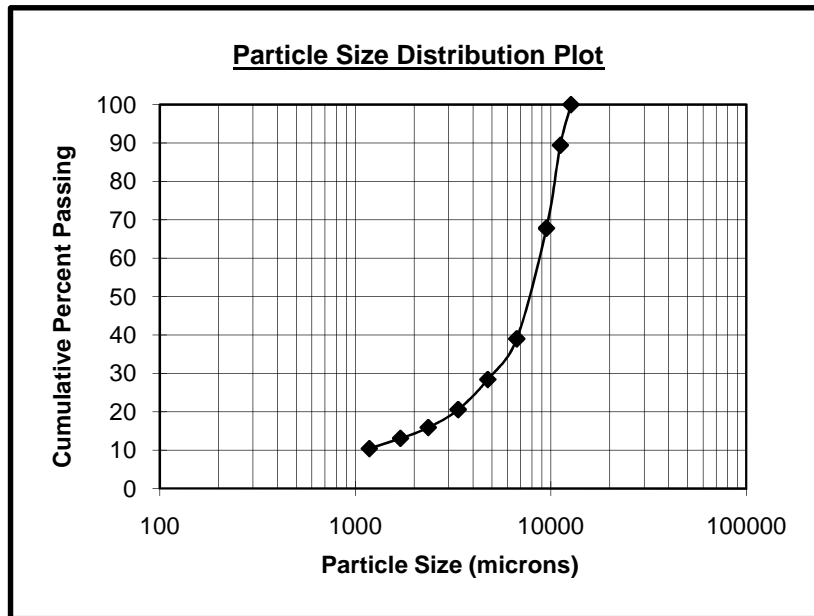

TABLE III-4E
ROD MILL SCREEN ANALYSIS
KM2543 High Bornite East Zone Feed 2

Product	Particle Size µm	Weight % Retained	Cumulative % Passing
1/2 Mesh	12700	0.00	100.0
7/16 Mesh	11200	11.42	88.6
3/8 Mesh	9510	19.28	69.3
3 Mesh	6700	29.54	39.8
4 Mesh	4760	10.41	29.3
6 Mesh	3360	7.93	21.4
8 Mesh	2360	5.53	15.9
10 Mesh	1700	3.08	12.8
14 Mesh	1180	2.75	10.0
TOTAL		100.00	**

K80 =10465µm

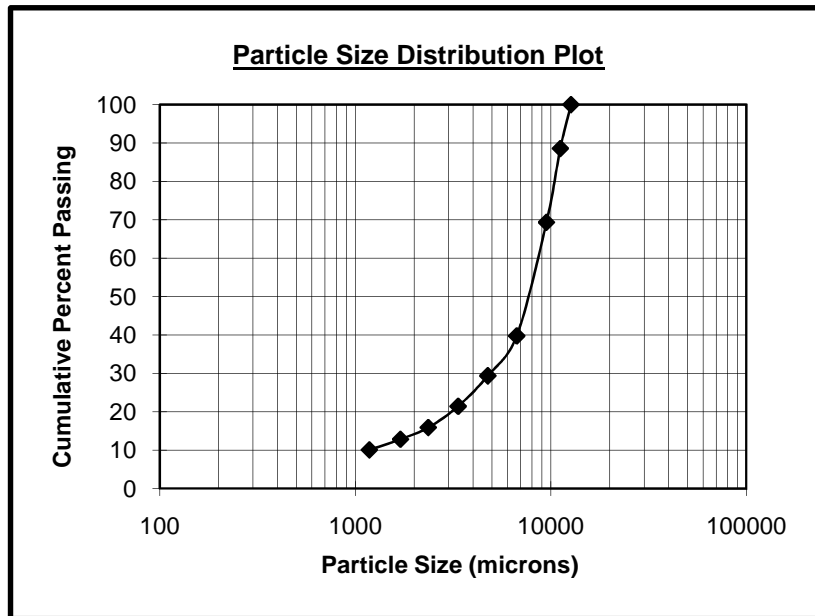

TABLE III-5A
BOND BALL GRINDABILITY TEST
KM2543 High Gold Copper Ratio East Zone

Weight of 700 ml Sample : 1433.4 g. Aperture Test Sieve : 106µm
 1/3.5 of Sample Weight : 409.5 g. Percent Undersize : 14.7%

Cycle	Weight of New Feed	Number of Revolutions	Weight of Undersize			
			Product	Feed	Net Product	Net / Rev
1	1433.4	100	298.8	210.7	88.1	0.88
2	298.8	415	580.3	43.9	536.4	1.29
3	580.3	251	439.8	85.3	354.5	1.41
4	439.8	244	401.1	64.7	336.4	1.38
5	401.1	254	424.0	59.0	365.0	1.44
6	424.0	242	409.3	62.3	347.0	1.43

BOND'S WORK INDEX FORMULA

$$W_i = 44.5 / (P_i^{.23} \times G_{pb}^{.82} \times (10/\sqrt{P} - 10/\sqrt{F}))$$

P_i = Sieve Size Tested

106 µm

G_{pb} = Net undersize produced per revolution of mill.

1.42 g.

P = 80% Passing size of test product.

85 µm

F = 80% Passing size of test feed.

1989 µm

WORK INDEX (W_i)

13.3 kw-hr/ton

14.6 kw-hr/tonne

NB: G_{pb} = Average of last 3 Net/Rev Cycles

TABLE III-5B
BOND BALL SCREEN ANALYSIS
CM2543 High Gold Copper Ratio East Zone - Cycle 6 Undersize

Product	Particle Size µm	Weight % Retained	Cumulative % Passing
150 Mesh	106	0.00	100.0
170 Mesh	90	16.25	83.7
200 Mesh	75	12.42	71.3
270 Mesh	53	18.62	52.7
325 Mesh	45	8.13	44.6
400 Mesh	38	3.61	41.0
TOTAL		100.00	**

K80 =85µm

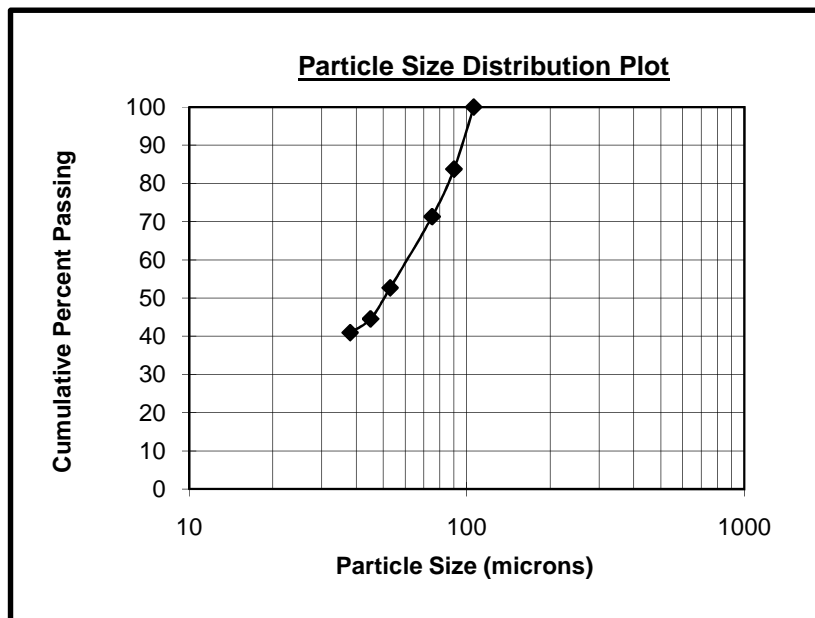

TABLE III-5C
BOND BALL SCREEN ANALYSIS
KM2543 High Gold Copper Ratio East Zone - Average Feed

Product	Particle Size µm	Weight % Retained	Cumulative % Passing
6 Mesh	3360	0.00	100.0
7 Mesh	2800	1.37	98.6
8 Mesh	2360	6.58	92.0
9 Mesh	2000	11.63	80.4
10 Mesh	1700	11.55	68.9
12 Mesh	1400	9.59	59.3
14 Mesh	1180	6.58	52.7
20 Mesh	850	9.51	43.2
28 Mesh	600	6.97	36.2
35 Mesh	425	5.13	31.1
48 Mesh	300	4.51	26.6
65 Mesh	212	4.25	22.3
100 Mesh	150	4.12	18.2
150 Mesh	106	3.52	14.7
TOTAL		100.00	**

K80 =1989µm

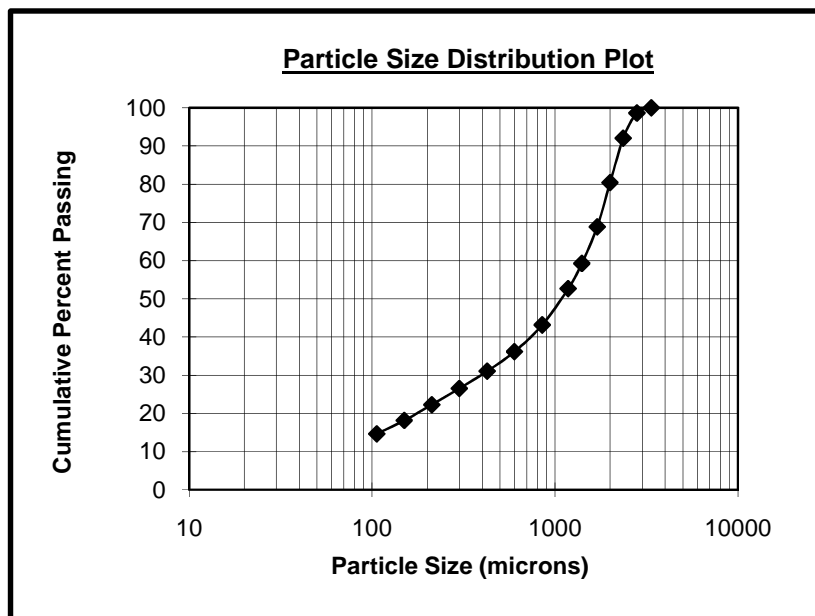

TABLE III-5D
BOND BALL SCREEN ANALYSIS
KM2543 High Gold Copper Ratio East Zone - Feed 1

Product	Particle Size µm	Weight % Retained	Cumulative % Passing
6 Mesh	3360	0.00	100.0
7 Mesh	2800	1.22	98.8
8 Mesh	2360	6.24	92.5
9 Mesh	2000	11.37	81.2
10 Mesh	1700	11.07	70.1
12 Mesh	1400	9.29	60.8
14 Mesh	1180	6.35	54.5
20 Mesh	850	9.54	44.9
28 Mesh	600	7.11	37.8
35 Mesh	425	5.18	32.6
48 Mesh	300	4.82	27.8
65 Mesh	212	4.52	23.3
100 Mesh	150	4.42	18.9
150 Mesh	106	3.81	15.1
TOTAL		100.00	**

K80 =1968µm

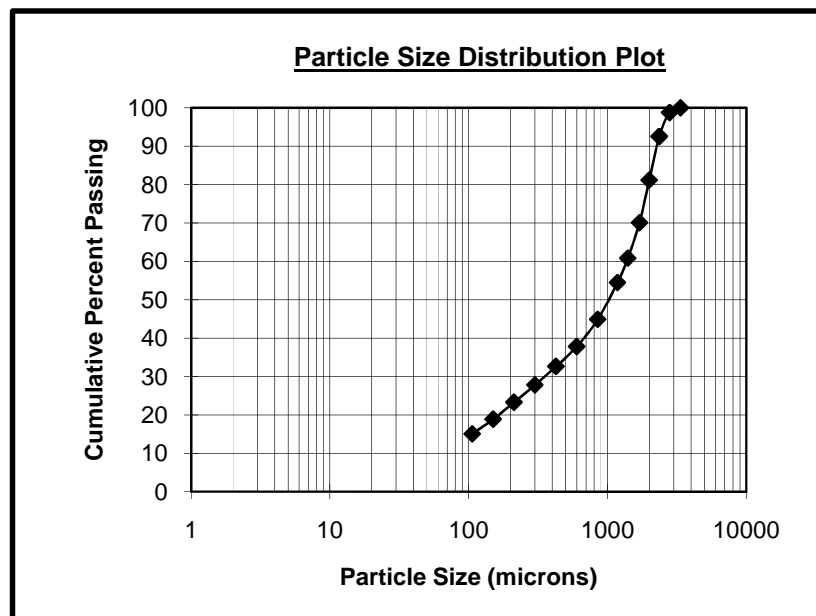

TABLE III-5E
BOND BALL SCREEN ANALYSIS
KM2543 High Gold Copper Ratio East Zone - Feed 2

Product	Particle Size µm	Weight % Retained	Cumulative % Passing
6 Mesh	3360	0.00	100.0
7 Mesh	2800	1.53	98.5
8 Mesh	2360	6.93	91.5
9 Mesh	2000	11.90	79.6
10 Mesh	1700	12.06	67.6
12 Mesh	1400	9.89	57.7
14 Mesh	1180	6.83	50.8
20 Mesh	850	9.47	41.4
28 Mesh	600	6.83	34.6
35 Mesh	425	5.08	29.5
48 Mesh	300	4.18	25.3
65 Mesh	212	3.97	21.3
100 Mesh	150	3.81	17.5
150 Mesh	106	3.23	14.3
TOTAL		100.00	**

K80 =2011µm

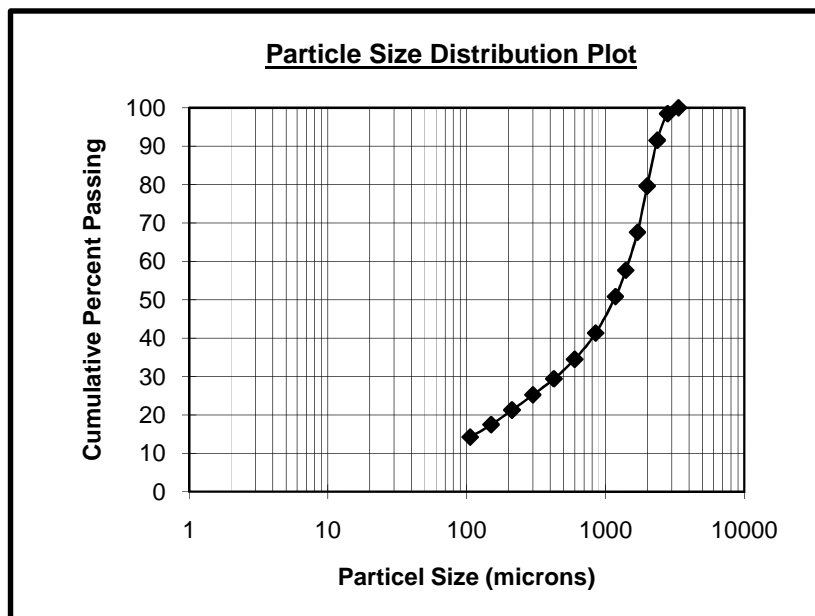

TABLE III-6A
BOND BALL GRINDABILITY TEST
KM2543 High Bornite East Zone

Weight of 700 ml Sample : 1389.5 g. Aperture Test Sieve : 106µm
1/3.5 of Sample Weight : 397.0 g. Percent Undersize : 10.7%

Cycle	Weight of New Feed	Number of Revolutions	Weight of Undersize			
			Product	Feed	Net Product	Net / Rev
1	1389.5	100	239.1	148.7	90.4	0.90
2	239.1	411	431.7	25.6	406.1	0.99
3	431.7	355	425.4	46.2	379.2	1.07
4	425.4	329	420.0	45.5	374.5	1.14
5	420.0	309	395.1	44.9	350.2	1.13
6	395.1	313	403.3	42.3	361.0	1.15

BOND'S WORK INDEX FORMULA

$$W_i = 44.5 / (P_i^{.23} \times G_{pb}^{.82} \times (10/\sqrt{P} - 10/\sqrt{F}))$$

P_i = Sieve Size Tested

106 µm

G_{pb} = Net undersize produced per revolution of mill.

1.14 g.

P = 80% Passing size of test product.

80 µm

F = 80% Passing size of test feed.

2154 µm

WORK INDEX (W_i)

15.1 kw-hr/ton

16.7 kw-hr/tonne

NB: G_{pb} = Average of last 3 Net/Rev Cycles

TABLE III-6B
BOND BALL SCREEN ANALYSIS
KM2543 High Bornite East Zone - Cycle 6 Undersize

Product	Particle Size μm	Weight % Retained	Cumulative % Passing
150 Mesh	106	0.00	100.0
170 Mesh	90	13.19	86.8
200 Mesh	75	10.39	76.4
270 Mesh	53	16.34	60.1
325 Mesh	45	7.58	52.5
400 Mesh	38	3.38	49.1
TOTAL		100.00	**

K80 =80μm

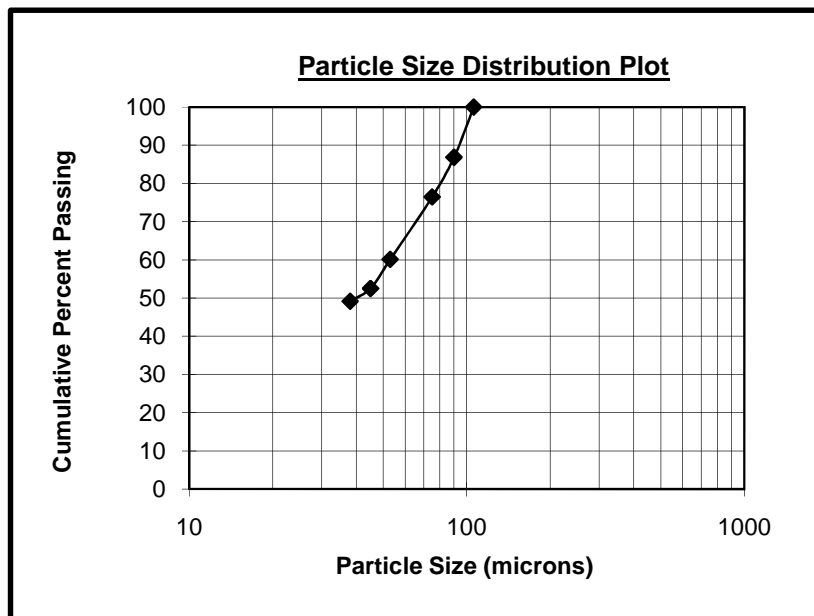

TABLE III-6C
BOND BALL SCREEN ANALYSIS
KM2543 High Bornite East Zone - Average Feed

Product	Particle Size μm	Weight % Retained	Cumulative % Passing
6 Mesh	3360	0.00	100.0
7 Mesh	2800	1.68	98.3
8 Mesh	2360	9.63	88.7
9 Mesh	2000	15.09	73.6
10 Mesh	1700	13.49	60.1
12 Mesh	1400	10.23	49.9
14 Mesh	1180	6.32	43.6
20 Mesh	850	9.31	34.2
28 Mesh	600	6.65	27.6
35 Mesh	425	4.80	22.8
48 Mesh	300	3.96	18.8
65 Mesh	212	3.31	15.5
100 Mesh	150	2.77	12.8
150 Mesh	106	2.01	10.7
TOTAL		100.00	**

K80 =2154μm

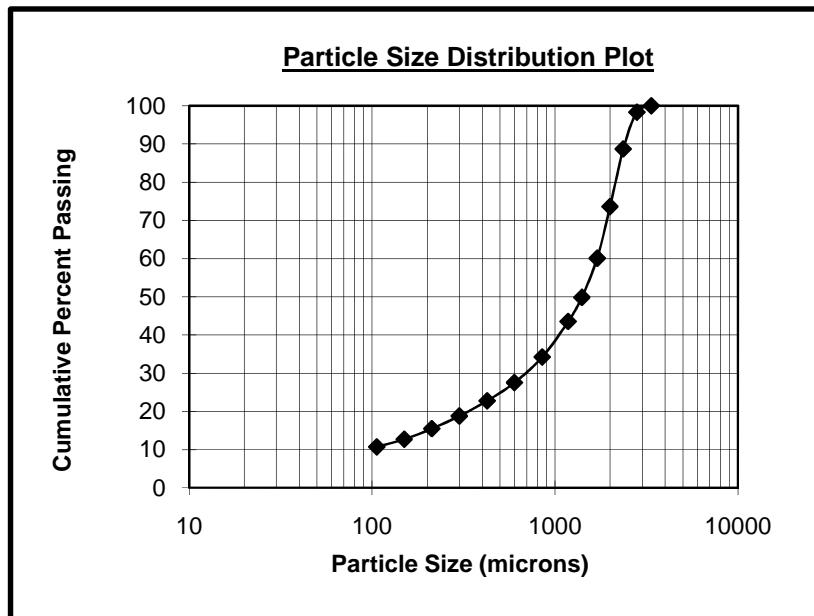

TABLE III-6D
BOND BALL SCREEN ANALYSIS
KM2543 High Bornite East Zone - Feed 1

Product	Particle Size µm	Weight % Retained	Cumulative % Passing
6 Mesh	3360	0.00	100.0
7 Mesh	2800	1.99	98.0
8 Mesh	2360	9.99	88.0
9 Mesh	2000	15.78	72.2
10 Mesh	1700	13.96	58.3
12 Mesh	1400	10.10	48.2
14 Mesh	1180	6.24	41.9
20 Mesh	850	8.97	33.0
28 Mesh	600	6.24	26.7
35 Mesh	425	4.54	22.2
48 Mesh	300	3.69	18.5
65 Mesh	212	3.12	15.4
100 Mesh	150	2.61	12.8
150 Mesh	106	1.93	10.8
TOTAL		100.00	**

K80 =2178µm

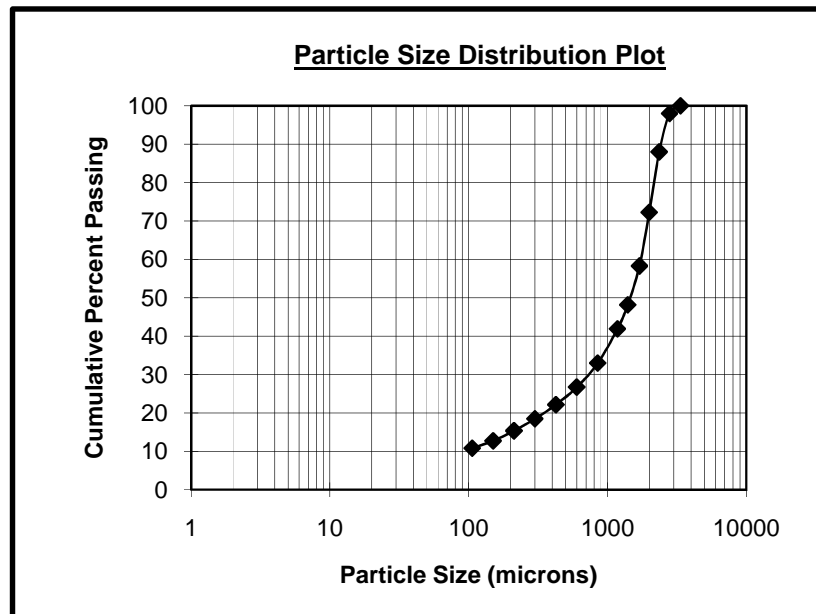

TABLE III-6E
BOND BALL SCREEN ANALYSIS
KM2543 High Bornite East Zone - Feed 2

Product	Particle Size µm	Weight % Retained	Cumulative % Passing
6 Mesh	3360	0.00	100.0
7 Mesh	2800	1.40	98.6
8 Mesh	2360	9.31	89.3
9 Mesh	2000	14.46	74.8
10 Mesh	1700	13.05	61.8
12 Mesh	1400	10.35	51.4
14 Mesh	1180	6.40	45.0
20 Mesh	850	9.62	35.4
28 Mesh	600	7.02	28.4
35 Mesh	425	5.04	23.3
48 Mesh	300	4.21	19.1
65 Mesh	212	3.48	15.7
100 Mesh	150	2.91	12.7
150 Mesh	106	2.08	10.7
TOTAL		100.00	**

K80 =2129µm

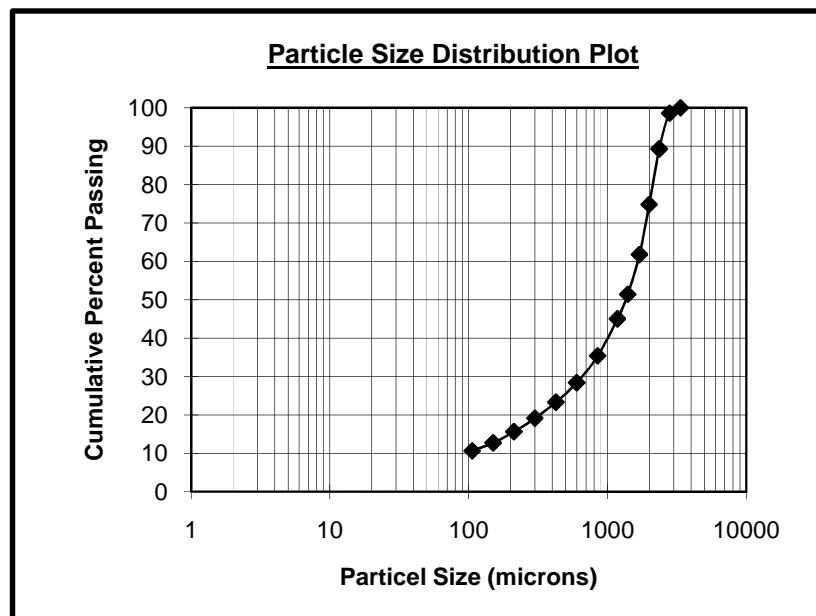

TABLE III-7
SCREEN ANALYSIS
KM2543 High Gold Copper Ratio East Zone
10 Minute Grind Calibration

Product	Particle Size μm	Weight % Retained	Cumulative % Passing
35 Mesh	425	0.00	100.0
48 Mesh	300	1.10	98.9
65 Mesh	212	13.60	85.3
100 Mesh	150	15.40	69.9
150 Mesh	106	13.80	56.1
200 Mesh	75	12.10	44.0
270 Mesh	53	9.90	34.1
400 Mesh	38	6.10	28.0
TOTAL		100.00	**

K80 =190 μm

Note: 10 min. grind calibration using 2 kg. Ore, 1000 ml water and
20 kg. of Mild Steel rods in Mill: M2

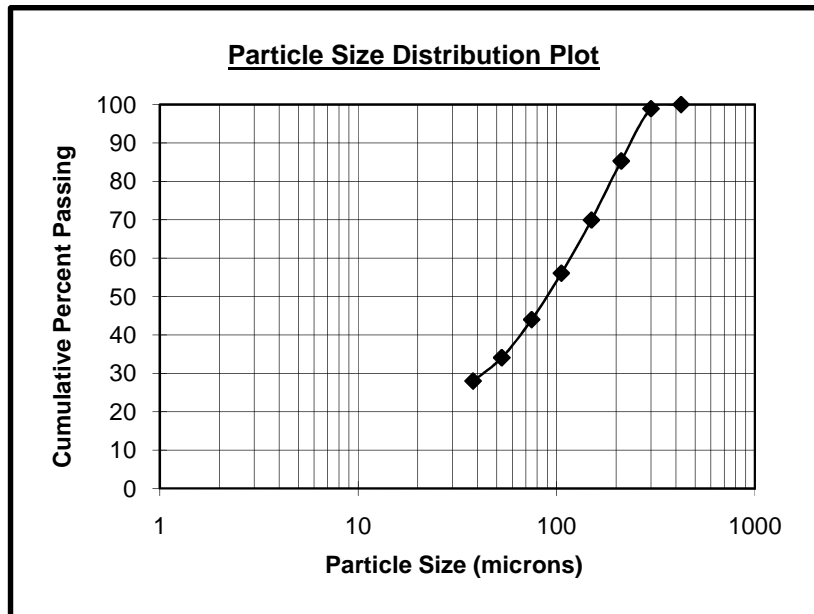

TABLE III-8
SCREEN ANALYSIS
KM2543 High Bornite East Zone
12 Minute Grind Calibration

Product	Particle Size μm	Weight % Retained	Cumulative % Passing
35 Mesh	425	0.00	100.0
48 Mesh	300	13.10	86.9
65 Mesh	212	18.60	68.3
100 Mesh	150	13.60	54.7
150 Mesh	106	9.50	45.2
200 Mesh	75	8.10	37.1
270 Mesh	53	6.40	30.7
400 Mesh	38	5.60	25.1
TOTAL		100.00	**

K80 =266 μm

Note: 12 min. grind calibration using 2 kg. Ore, 1000 ml water and
20 kg. of Mild Steel rods in Mill: M2

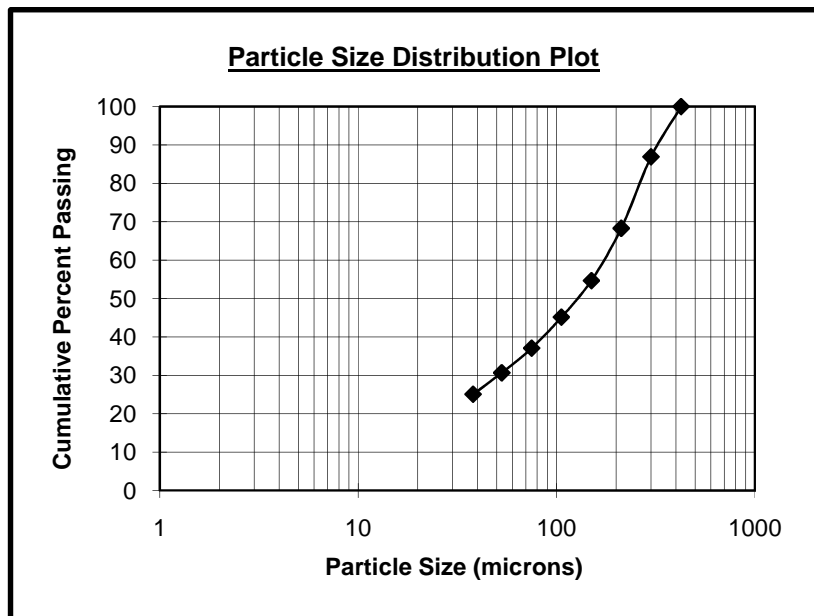

TABLE III-9
SCREEN ANALYSIS
KM2543 High Bornite East Zone
15 Minute Grind Calibration

Product	Particle Size μm	Weight % Retained	Cumulative % Passing
35 Mesh	425	0.00	100.0
48 Mesh	300	0.70	99.3
65 Mesh	212	11.10	88.2
100 Mesh	150	13.80	74.4
150 Mesh	106	12.20	62.2
200 Mesh	75	8.90	53.3
270 Mesh	53	8.40	44.9
400 Mesh	38	5.90	39.0
TOTAL		100.00	**

K80 = 174 μm

Note: 15 min. grind calibration using 2 kg. Ore, 1000 ml water and
20 kg. of Mild Steel rods in Mill: M2

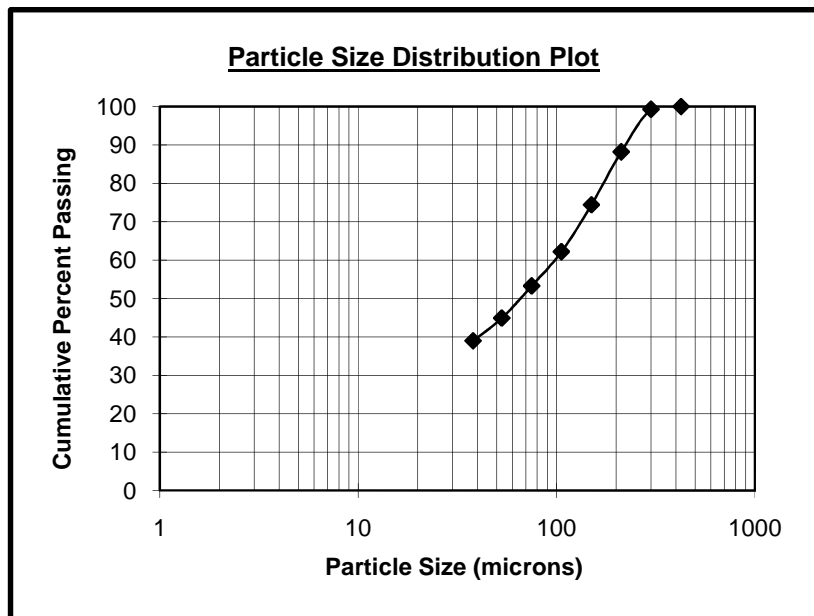

TABLE III-10
CYCLOSIZING ANALYSIS
KM2543 High Gold Copper Ratio East Zone
12 Minute Grind Calibration

Product	Size (μm)		Weight % Retained	Cumulative % Passing
	Limiting	Effective		
35 Mesh	425	425	0.00	100.0
48 Mesh	300	300	0.10	99.9
65 Mesh	212	212	5.40	94.5
100 Mesh	150	150	16.40	78.1
150 Mesh	106	106	19.10	59.0
200 Mesh	75	75	13.80	45.2
270 Mesh	53	53	11.50	33.7
Cyclone 1	45	49	0.80	32.9
Cyclone 2	31	34	3.90	29.0
Cyclone 3	22	24	6.80	22.2
Cyclone 4	15	17	4.80	17.4
Cyclone 5	12	13	3.10	14.3
Total			100.00	**

Operating Conditions	Measured	Factor
Temperature ($^{\circ}\text{C}$)	7.70	1.179
Specific Gravity	2.83	0.958
Flow Rate (mm)	180	1.012
Elutriation Time (min)	20	0.955
Overall Factor		1.092
K80 Size (microns)		157

Note: 12 min. grind calibration using 2 kg. Ore, 1000 ml water and
20 kg. of Mild Steel rods in Mill: M2

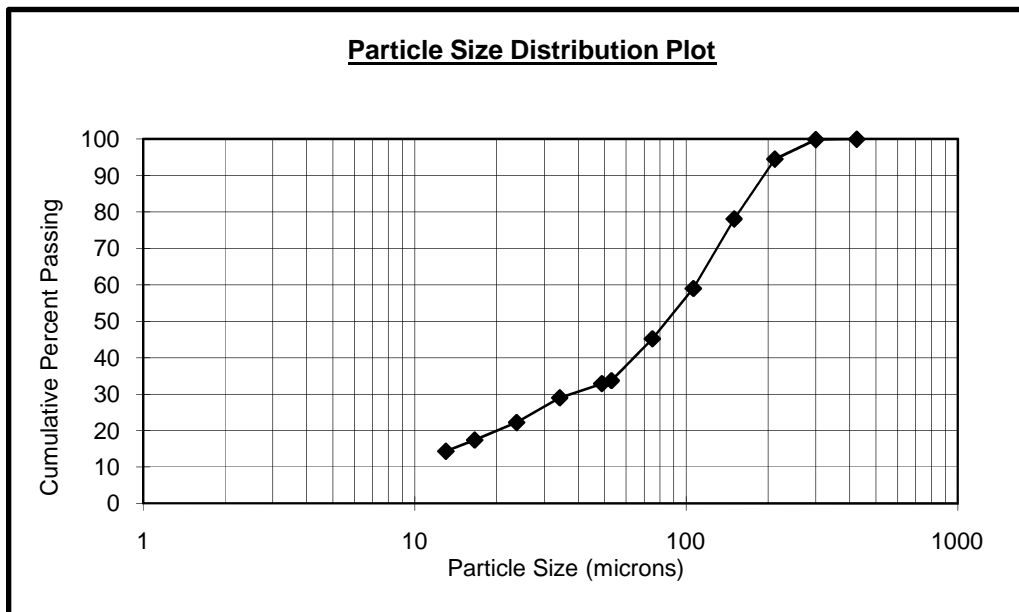
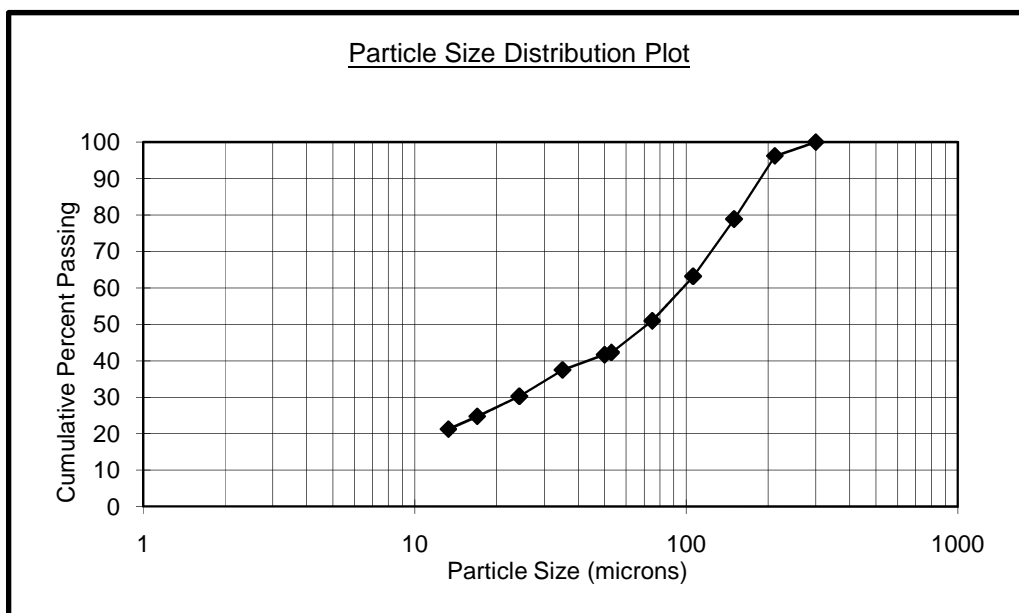

TABLE III-11
CYCLOSIZING ANALYSIS
KM2543 High Bornite East Zone
17 Minute Grind Calibration

Product	Size (μm)		Weight % Retained	Cumulative % Passing
	Limiting	Effective		
48 Mesh	300	300	0.00	100.0
65 Mesh	212	212	3.80	96.2
100 Mesh	150	150	17.30	78.9
150 Mesh	106	106	15.70	63.2
200 Mesh	75	75	12.20	51.0
270 Mesh	53	53	8.70	42.3
Cyclone 1	45	50	0.60	41.7
Cyclone 2	31	35	4.20	37.5
Cyclone 3	22	24	7.20	30.3
Cyclone 4	15	17	5.50	24.8
Cyclone 5	12	13	3.50	21.3
Total			100.00	**

Operating Conditions	Measured	Factor
Temperature ($^{\circ}\text{C}$)	7.70	1.179
Specific Gravity	2.75	0.983
Flow Rate (mm)	180	1.012
Elutriation Time (min)	20	0.955
Overall Factor		1.120
K80 Size (microns)		154

Note: 17 min. grind calibration using 2 kg. Ore, 1000 ml water and
20 kg. of Mild Steel rods in Mill: M2





G & T METALLURGICAL SERVICES LTD.



ISO9001:2008
Certificate No. FS63170

Result Analysis Report

Project and Test number:

KM2543-03

Measured by:

Dean

Measured:

Wednesday, January 27, 2010 3:51:47 PM

Sample Name:

Copper Regrind Discharge - Average

Edited by:

Dean

Analysed:

Wednesday, January 27, 2010 3:51:48 PM

Particle Name:

Silica 0.01

Accessory Name:

Hydro 2000MU (A)

Analysis model:

General purpose

Sensitivity:

Normal

Particle RI:

1.544

Absorption:

0.01

Size range:

0.100 to 1000.000 um

Obscuration:

14.63 %

Dispersant Name:

Water

Dispersant RI:

1.330

Weighted Residual:

0.498 %

Result Emulation:

Off

Concentration:

0.0179 %Vol

Span :

2.304

Uniformity:

0.711

Result units:

Volume

Specific Surface Area:

0.237 m²/g

Surface Weighted Mean D[3,2]:

9.545 um

Vol. Weighted Mean D[4,3]:

22.802 um

d(0.1): 3.796 um d(0.5): 19.050 um **d(0.8): 36.537 um** d(0.9): 47.684 um d(0.98): 67.59 um

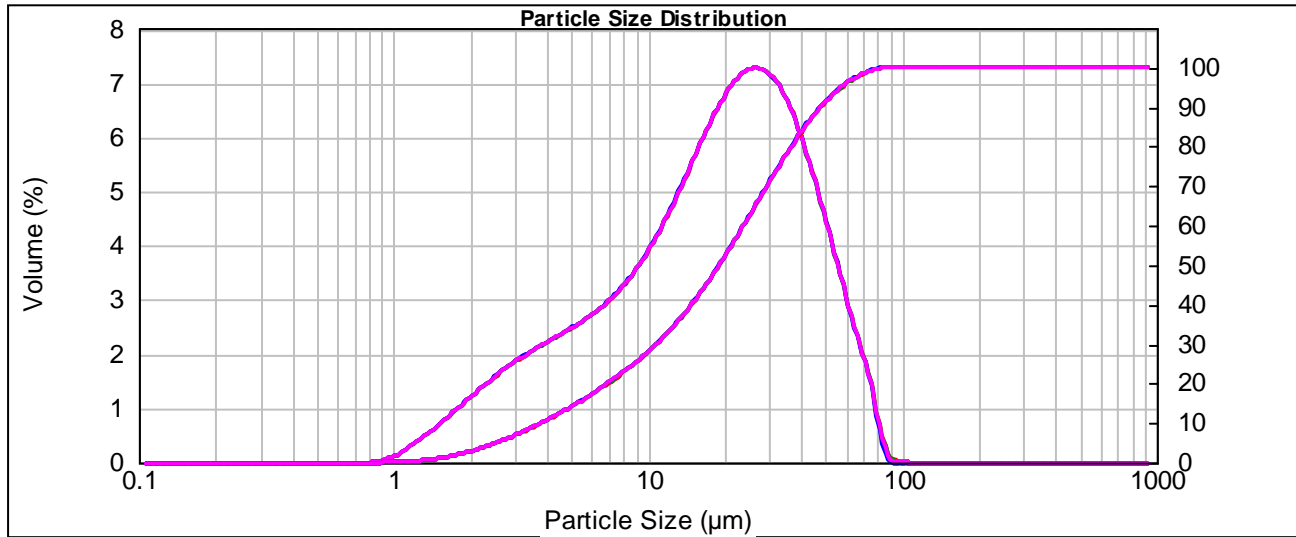

Size (µm)	Volume In %	Size (µm)	Volume In %	Size (µm)	Volume In %	Size (µm)	Volume In %	Size (µm)	Volume In %	Size (µm)	Volume In %
0.100	0.00	0.479	0.00	2.291	0.91	10.965	2.65	52.481	2.27	251.189	0.00
0.110	0.00	0.525	0.00	2.512	1.00	12.023	2.88	57.544	1.83	275.423	0.00
0.120	0.00	0.575	0.00	2.754	1.08	13.183	3.13	63.096	1.41	301.995	0.00
0.132	0.00	0.631	0.00	3.020	1.16	14.454	3.38	69.183	1.07	331.131	0.00
0.145	0.00	0.692	0.00	3.311	1.23	15.849	3.63	75.858	0.55	363.078	0.00
0.158	0.00	0.759	0.00	3.631	1.30	17.378	3.86	83.176	0.06	398.107	0.00
0.174	0.00	0.832	0.00	3.981	1.37	19.055	4.07	91.201	0.00	436.516	0.00
0.191	0.00	0.912	0.01	4.365	1.43	20.893	4.23	100.000	0.00	478.630	0.00
0.209	0.00	1.000	0.05	4.786	1.50	22.909	4.35	109.648	0.00	524.807	0.00
0.229	0.00	1.096	0.09	5.248	1.56	25.119	4.39	120.226	0.00	575.440	0.00
0.251	0.00	1.202	0.17	5.754	1.64	27.542	4.36	131.826	0.00	630.957	0.00
0.275	0.00	1.318	0.24	6.310	1.73	30.200	4.25	144.544	0.00	691.831	0.00
0.302	0.00	1.445	0.33	6.918	1.83	33.113	4.07	158.489	0.00	758.578	0.00
0.331	0.00	1.585	0.42	7.586	1.95	36.308	3.80	173.780	0.00	831.764	0.00
0.363	0.00	1.738	0.52	8.318	2.09	39.811	3.48	190.546	0.00	912.011	0.00
0.398	0.00	1.905	0.62	9.120	2.25	43.652	3.10	208.930	0.00	1000.000	0.00
0.437	0.00	2.089	0.72	10.000	2.44	47.863	2.69	229.087	0.00		
0.479	0.00	2.291	0.82	10.965	2.69	52.481	2.69	251.189	0.00		

Operator notes:



Result Analysis Report

Project and Test number:

KM2543-04

Measured by:

Dean

Measured:

Wednesday, January 27, 2010 3:16:46 PM

Sample Name:

Copper Regrind Discharge - Average

Edited by:

Dean

Analysed:

Wednesday, January 27, 2010 3:16:47 PM

Particle Name:

Silica 0.01

Accessory Name:

Hydro 2000MU (A)

Analysis model:

General purpose

Sensitivity:

Normal

Particle RI:

1.544

Absorption:

0.01

Size range:

0.100 to 1000.000 um

Obscuration:

12.51 %

Dispersant Name:

Water

Dispersant RI:

1.330

Weighted Residual:

0.187 %

Result Emulation:

Off

Concentration:

0.0096 %Vol

Span :

2.994

Uniformity:

0.942

Result units:

Volume

Specific Surface Area:

0.37 m²/g

Surface Weighted Mean D[3,2]:

6.124 um

Vol. Weighted Mean D[4,3]:

16.125 um

d(0.1): 2.465 um d(0.5): 11.465 um **d(0.8): 26.332 um** d(0.9): 36.788 um d(0.98): 58.48 um

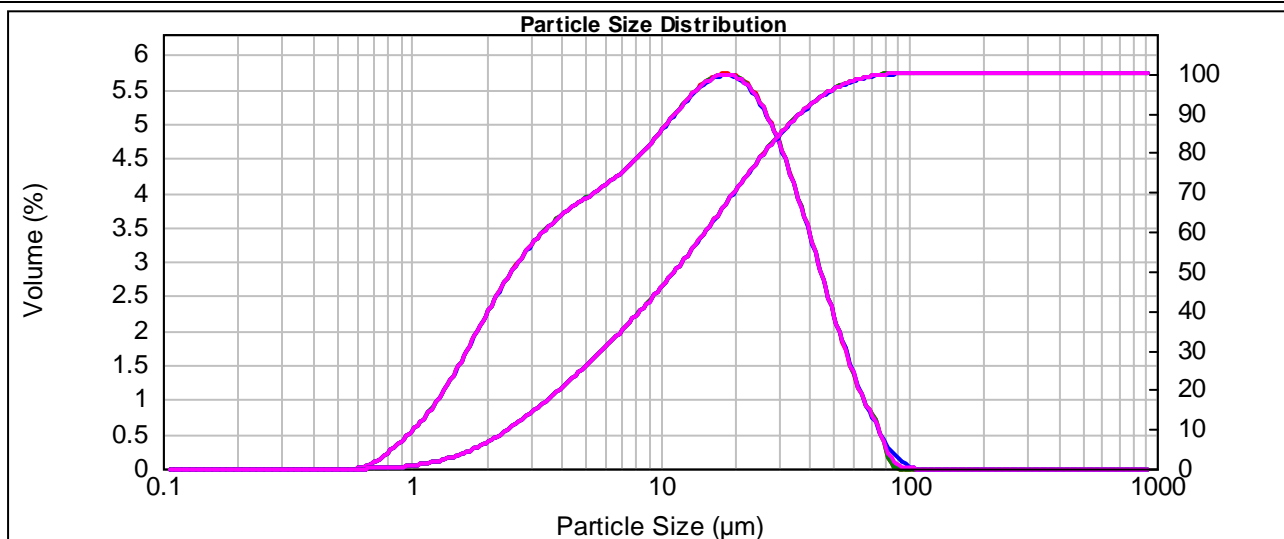

Size (µm)	Volume In %	Size (µm)	Volume In %	Size (µm)	Volume In %	Size (µm)	Volume In %	Size (µm)	Volume In %	Size (µm)	Volume In %
0.100	0.00	0.479	0.00	2.291	1.64	10.965	3.09	52.481	1.07	251.189	0.00
0.110	0.00	0.525	0.00	2.512	1.77	12.023	3.19	57.544	0.82	275.423	0.00
0.120	0.00	0.575	0.00	2.754	1.89	13.183	3.29	63.096	0.60	301.995	0.00
0.132	0.00	0.631	0.02	3.020	1.99	14.454	3.36	69.183	0.44	331.131	0.00
0.145	0.00	0.692	0.06	3.311	2.09	15.849	3.42	75.858	0.24	363.078	0.00
0.158	0.00	0.759	0.13	3.631	2.17	17.378	3.44	83.176	0.05	398.107	0.00
0.174	0.00	0.832	0.21	3.981	2.24	19.055	3.43	91.201	0.00	436.516	0.00
0.191	0.00	0.912	0.28	4.365	2.30	20.893	3.37	100.000	0.00	478.630	0.00
0.209	0.00	1.000	0.36	4.786	2.36	22.909	3.27	109.648	0.00	524.807	0.00
0.229	0.00	1.096	0.46	5.248	2.41	25.119	3.13	120.226	0.00	575.440	0.00
0.251	0.00	1.202	0.58	5.754	2.47	27.542	3.13	131.826	0.00	630.957	0.00
0.275	0.00	1.318	0.71	6.310	2.54	30.200	2.95	144.544	0.00	691.831	0.00
0.302	0.00	1.445	0.86	6.918	2.61	33.113	2.73	158.489	0.00	758.578	0.00
0.331	0.00	1.585	1.02	7.586	2.69	36.308	2.48	173.780	0.00	831.764	0.00
0.363	0.00	1.738	1.18	8.318	2.78	39.811	2.20	190.546	0.00	912.011	0.00
0.398	0.00	1.905	1.34	9.120	2.88	43.652	1.92	208.930	0.00	1000.000	0.00
0.437	0.00	2.089	1.50	10.000	2.98	47.863	1.63	229.087	0.00		
0.479	0.00	2.291		10.965		52.481	1.34	251.189	0.00		

Operator notes:



G & T METALLURGICAL SERVICES LTD.



ISO9001:2008
Certificate No. FS63170

Result Analysis Report

Project and Test number:

KM2543-07

Measured by:

ryanm

Measured:

Friday, January 29, 2010 11:54:31 AM

Sample Name:

Copper Regrind Discharge - Average

Edited by:

ryanm

Analysed:

Friday, January 29, 2010 11:54:32 AM

Particle Name:

Silica 0.1

Accessory Name:

Hydro 2000MU (A)

Analysis model:

General purpose

Sensitivity:

Normal

Particle RI:

1.544

Absorption:

0.1

Size range:

0.100 to 1000.000 um

Obscuration:

14.98 %

Dispersant Name:

Water

Dispersant RI:

1.330

Weighted Residual:

0.373 %

Result Emulation:

Off

Concentration:

0.0110 %Vol

Span :

3.140

Uniformity:

1.02

Result units:

Volume

Specific Surface Area:

0.47 m²/g

Surface Weighted Mean D[3,2]:

4.816 um

Vol. Weighted Mean D[4,3]:

16.735 um

d(0.1): 1.914 um d(0.5): 11.365 um **d(0.8): 25.980 um** d(0.9): 37.605 um d(0.98): 69.45 um

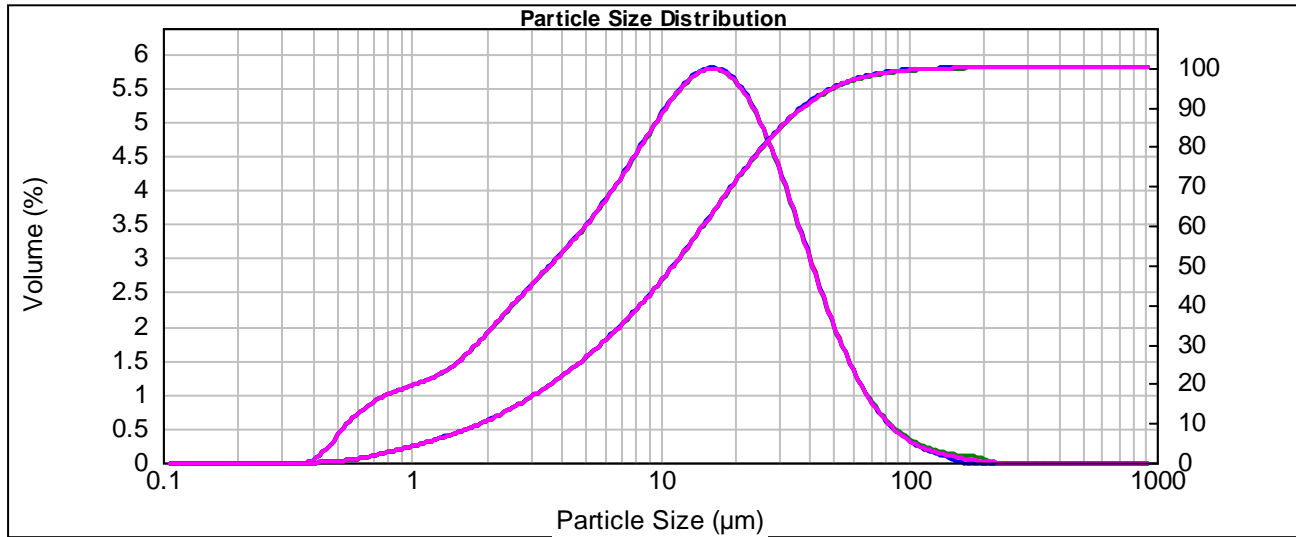

Size (µm)	Volume In %	Size (µm)	Volume In %	Size (µm)	Volume In %	Size (µm)	Volume In %	Size (µm)	Volume In %	Size (µm)	Volume In %
0.100	0.00	0.479	0.22	2.291	1.32	10.965	3.24	52.481	1.00	251.189	0.00
0.110	0.00	0.525	0.35	2.512	1.42	12.023	3.34	57.544	0.81	275.423	0.00
0.120	0.00	0.575	0.42	2.754	1.51	13.183	3.42	63.096	0.64	301.995	0.00
0.132	0.00	0.631	0.49	3.020	1.60	14.454	3.47	69.183	0.51	331.131	0.00
0.145	0.00	0.692	0.55	3.311	1.70	15.849	3.48	75.858	0.39	363.078	0.00
0.158	0.00	0.759	0.60	3.631	1.79	17.378	3.45	83.176	0.30	398.107	0.00
0.174	0.00	0.832	0.63	3.981	1.88	19.055	3.38	91.201	0.23	436.516	0.00
0.191	0.00	0.912	0.66	4.365	1.98	20.893	3.27	100.000	0.17	478.630	0.00
0.209	0.00	1.000	0.69	4.786	2.08	22.909	3.11	109.648	0.13	524.807	0.00
0.229	0.00	1.096	0.72	5.248	2.19	25.119	2.93	120.226	0.10	575.440	0.00
0.251	0.00	1.202	0.76	5.754	2.31	27.542	2.71	131.826	0.07	630.957	0.00
0.275	0.00	1.318	0.81	6.310	2.44	30.200	2.47	144.544	0.05	691.831	0.00
0.302	0.00	1.445	0.87	6.918	2.57	33.113	2.22	158.489	0.03	758.578	0.00
0.331	0.00	1.585	0.95	7.586	2.71	36.308	1.95	173.780	0.02	831.764	0.00
0.363	0.00	1.738	1.04	8.318	2.85	39.811	1.69	190.546	0.01	912.011	0.00
0.398	0.04	1.905	1.13	9.120	2.98	43.652	1.45	208.930	0.00	1000.000	0.00
0.437	0.13	2.089	1.23	10.000	3.12	47.863	1.21	229.087	0.00		
0.479		2.291		10.965		52.481		251.189			

Operator notes:



Result Analysis Report

Project and Test number: KM2543-08
Sample Name: Copper Regrind Discharge - Average
Measured by: ryanm
Edited by: ryanm
Measured: Friday, January 29, 2010 12:55:36 PM
Analysed: Friday, January 29, 2010 12:55:37 PM

Particle Name: Silica 0.01
Particle RI: 1.544
Dispersant Name: Water
Accessory Name: Hydro 2000MU (A)
Absorption: 0.01
Dispersant RI: 1.330
Analysis model: General purpose
Size range: 0.100 to 1000.000 um
Weighted Residual: 0.301 %
Sensitivity: Normal
Obscuration: 15.87 %
Result Emulation: Off

Concentration: 0.0130 %Vol
Span : 3.502
Uniformity: 1.1
Result units: Volume
Specific Surface Area: 0.352 m²/g
Surface Weighted Mean D[3,2]: 6.436 um
Vol. Weighted Mean D[4,3]: 20.813 um

d(0.1): 2.480 um d(0.5): 13.697 um **d(0.8): 35.926 um** d(0.9): 50.443 um d(0.98): 77.08 um

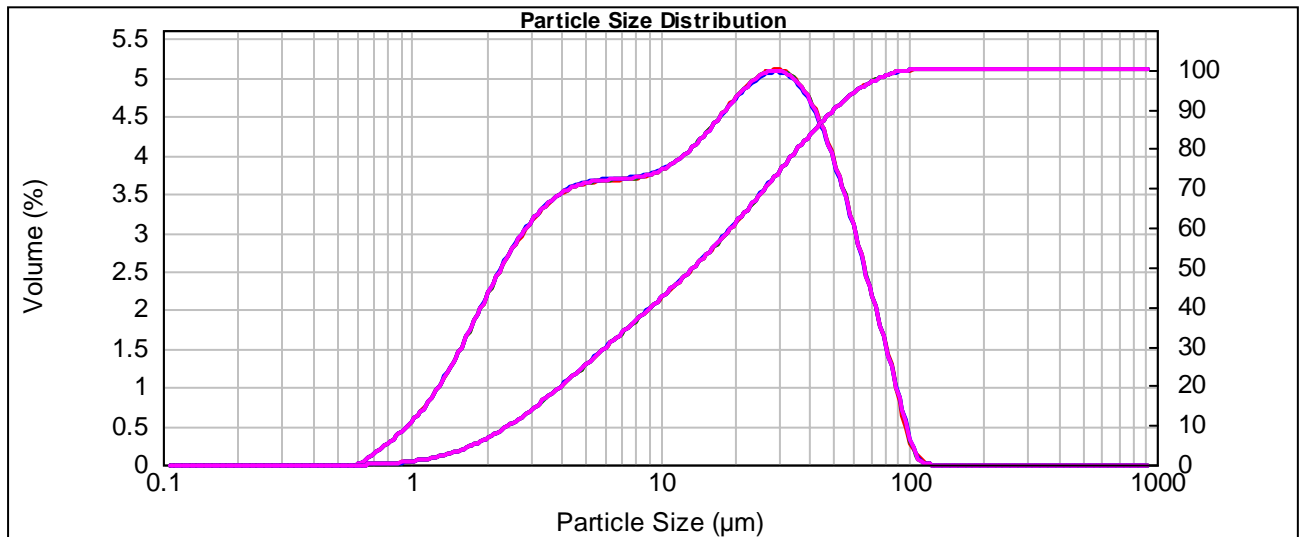

Size (µm)	Volume In %	Size (µm)	Volume In %	Size (µm)	Volume In %	Size (µm)	Volume In %	Size (µm)	Volume In %	Size (µm)	Volume In %
0.100	0.00	0.479	0.00	2.291	1.59	10.965	2.35	52.481	2.13	251.189	0.00
0.110	0.00	0.525	0.00	2.512	1.72	12.023	2.41	57.544	1.85	275.423	0.00
0.120	0.00	0.575	0.00	2.754	1.84	13.183	2.48	63.096	1.56	301.995	0.00
0.132	0.00	0.631	0.04	3.020	1.93	14.454	2.56	69.183	1.27	331.131	0.00
0.145	0.00	0.692	0.10	3.311	2.01	15.849	2.65	75.858	0.99	363.078	0.00
0.158	0.00	0.759	0.15	3.631	2.08	17.378	2.75	83.176	0.70	398.107	0.00
0.174	0.00	0.832	0.22	3.981	2.13	19.055	2.84	91.201	0.39	436.516	0.00
0.191	0.00	0.912	0.29	4.365	2.17	20.893	2.92	100.000	0.11	478.630	0.00
0.209	0.00	1.000	0.37	4.786	2.19	22.909	2.99	109.648	0.00	524.807	0.00
0.229	0.00	1.096	0.47	5.248	2.21	25.119	3.04	120.226	0.00	575.440	0.00
0.251	0.00	1.202	0.58	5.754	2.21	27.542	3.06	131.826	0.00	630.957	0.00
0.275	0.00	1.318	0.70	6.310	2.22	30.200	3.05	144.544	0.00	691.831	0.00
0.302	0.00	1.445	0.84	6.918	2.22	33.113	3.00	158.489	0.00	758.578	0.00
0.331	0.00	1.585	0.99	7.586	2.23	36.308	2.91	173.780	0.00	831.764	0.00
0.363	0.00	1.738	1.14	8.318	2.25	39.811	2.77	190.546	0.00	912.011	0.00
0.398	0.00	1.905	1.30	9.120	2.27	43.652	2.59	208.930	0.00	1000.000	0.00
0.437	0.00	2.089	1.45	10.000	2.31	47.863	2.37	229.087	0.00		
0.479	0.00	2.291		10.965		52.481		251.189	0.00		

Operator notes:



Result Analysis Report

Project and Test number:

KM2543-09

Measured by:

Lindsay

Measured:

Tuesday, February 02, 2010 10:00:33 AM

Sample Name:

Copper Regrind Discharge

Edited by:

Analysed:

Tuesday, February 02, 2010 10:00:34 AM

Particle Name:

Silica 0.1

Accessory Name:

Hydro 2000MU (A)

Analysis model:

General purpose

Sensitivity:

Normal

Particle RI:

1.544

Absorption:

0.1

Size range:

0.100 to 1000.000 um

Obscuration:

14.25 %

Dispersant Name:

Water

Dispersant RI:

1.330

Weighted Residual:

0.472 %

Result Emulation:

Off

Concentration:

0.0103 %Vol

Span :

3.530

Uniformity:

1.29

Result units:

Volume

Specific Surface Area:

0.478 m²/g

Surface Weighted Mean D[3,2]:

4.734 um

Vol. Weighted Mean D[4,3]:

19.915 um

d(0.1): 1.831 um d(0.5): 11.569 um **d(0.8): 28.139 um** d(0.9): 42.669 um d(0.98): 104.58 um

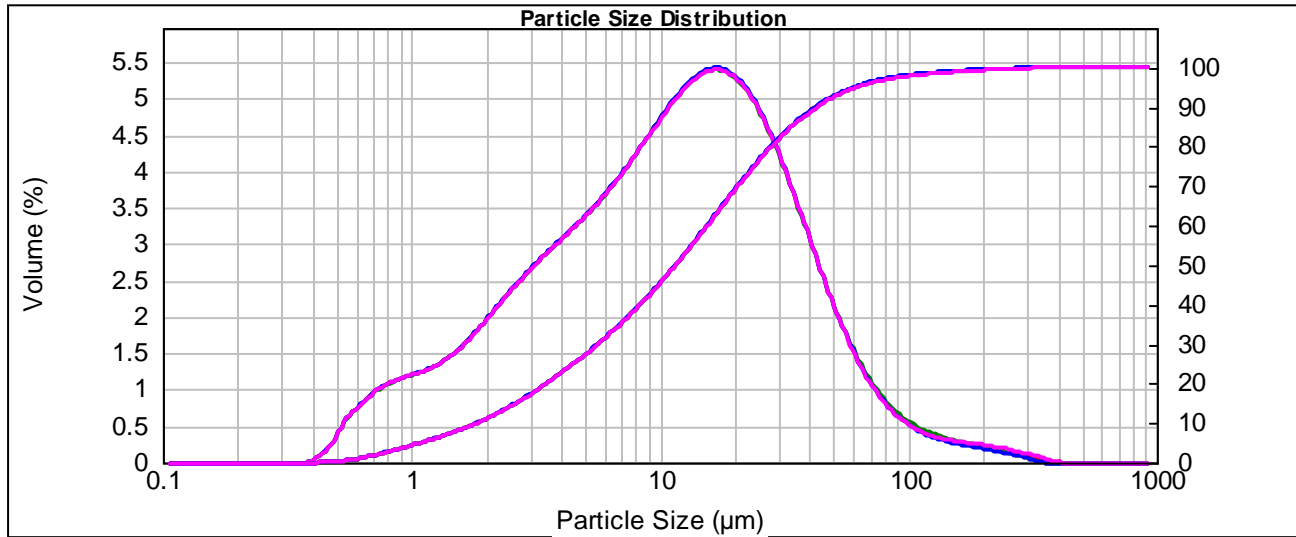

Size (µm)	Volume In %	Size (µm)	Volume In %	Size (µm)	Volume In %	Size (µm)	Volume In %	Size (µm)	Volume In %	Size (µm)	Volume In %
0.100	0.00	0.479	0.22	2.291	1.37	10.965	3.00	52.481	1.09	251.189	0.10
0.110	0.00	0.525	0.37	2.512	1.46	12.023	3.09	57.544	0.91	275.423	0.08
0.120	0.00	0.575	0.45	2.754	1.55	13.183	3.17	63.096	0.75	301.995	0.06
0.132	0.00	0.631	0.53	3.020	1.64	14.454	3.23	69.183	0.62	331.131	0.04
0.145	0.00	0.692	0.60	3.311	1.72	15.849	3.25	75.858	0.50	363.078	0.01
0.158	0.00	0.759	0.64	3.631	1.80	17.378	3.24	83.176	0.41	398.107	0.00
0.174	0.00	0.832	0.68	3.981	1.88	19.055	3.19	91.201	0.34	436.516	0.00
0.191	0.00	0.912	0.71	4.365	1.96	20.893	3.11	100.000	0.29	478.630	0.00
0.209	0.00	1.000	0.74	4.786	2.04	22.909	2.99	109.648	0.25	524.807	0.00
0.229	0.00	1.096	0.76	5.248	2.12	25.119	2.83	120.226	0.22	575.440	0.00
0.251	0.00	1.202	0.80	5.754	2.22	27.542	2.65	131.826	0.20	630.957	0.00
0.275	0.00	1.318	0.85	6.310	2.32	30.200	2.44	144.544	0.18	691.831	0.00
0.302	0.00	1.445	0.91	6.918	2.42	33.113	2.22	158.489	0.17	758.578	0.00
0.331	0.00	1.585	0.99	7.586	2.54	36.308	1.98	173.780	0.16	831.764	0.00
0.363	0.00	1.738	1.08	8.318	2.65	39.811	1.75	190.546	0.15	912.011	0.00
0.398	0.04	1.905	1.18	9.120	2.77	43.652	1.52	208.930	0.13	1000.000	0.00
0.437	0.11	2.089	1.27	10.000	2.89	47.863	1.30	229.087	0.12		
0.479		2.291		10.965		52.481		251.189			

Operator notes:



Result Analysis Report

Project and Test number:

KM2543-10

Measured by:

Wendy

Measured:

Tuesday, February 02, 2010 11:57:26 AM

Sample Name:

Copper Regrind Discharge - Average

Edited by:

Wendy

Analysed:

Tuesday, February 02, 2010 11:57:27 AM

Particle Name:

Silica 0.01

Accessory Name:

Hydro 2000MU (A)

Analysis model:

General purpose

Sensitivity:

Normal

Particle RI:

1.544

Absorption:

0.01

Size range:

0.100 to 1000.000 um

Obscuration:

14.70 %

Dispersant Name:

Water

Dispersant RI:

1.330

Weighted Residual:

0.404 %

Result Emulation:

Off

Concentration:

0.0104 %Vol

Span :

2.988

Uniformity:

0.933

Result units:

Volume

Specific Surface Area:

0.403 m²/g

Surface Weighted Mean D[3,2]:

5.612 um

Vol. Weighted Mean D[4,3]:

14.141 um

d(0.1): 2.295 um d(0.5): 10.069 um **d(0.8): 23.282 um** d(0.9): 32.377 um d(0.98): 49.84 um

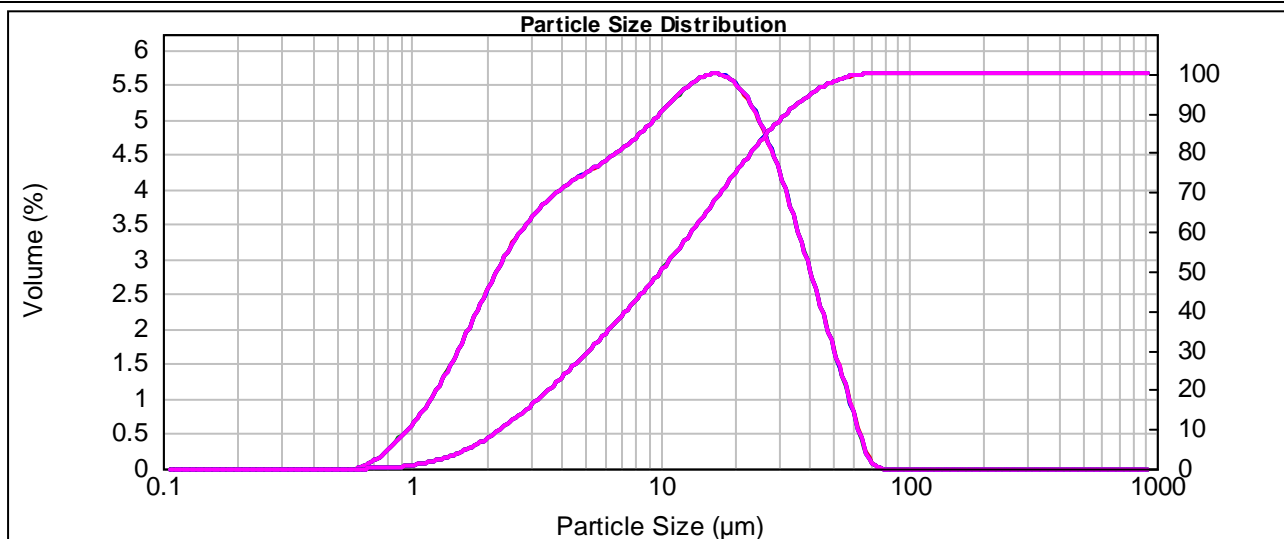

Size (µm)	Volume In %	Size (µm)	Volume In %	Size (µm)	Volume In %	Size (µm)	Volume In %	Size (µm)	Volume In %	Size (µm)	Volume In %
0.100	0.00	0.479	0.00	2.291	1.84	10.965	3.20	52.481	0.76	251.189	0.00
0.110	0.00	0.525	0.00	2.512	1.98	12.023	3.28	57.544	0.48	275.423	0.00
0.120	0.00	0.575	0.00	2.754	2.10	13.183	3.34	63.096	0.20	301.995	0.00
0.132	0.00	0.631	0.03	3.020	2.21	14.454	3.39	69.183	0.02	331.131	0.00
0.145	0.00	0.692	0.08	3.311	2.30	15.849	3.41	75.858	0.00	363.078	0.00
0.158	0.00	0.759	0.15	3.631	2.37	17.378	3.39	83.176	0.00	398.107	0.00
0.174	0.00	0.832	0.24	3.981	2.44	19.055	3.33	91.201	0.00	436.516	0.00
0.191	0.00	0.912	0.32	4.365	2.50	20.893	3.23	100.000	0.00	478.630	0.00
0.209	0.00	1.000	0.42	4.786	2.55	22.909	3.09	109.648	0.00	524.807	0.00
0.229	0.00	1.096	0.54	5.248	2.60	25.119	2.91	120.226	0.00	575.440	0.00
0.251	0.00	1.202	0.67	5.754	2.65	27.542	2.69	131.826	0.00	630.957	0.00
0.275	0.00	1.318	0.82	6.310	2.71	30.200	2.44	144.544	0.00	691.831	0.00
0.302	0.00	1.445	0.98	6.918	2.77	33.113	2.17	158.489	0.00	758.578	0.00
0.331	0.00	1.585	1.16	7.586	2.85	36.308	1.88	173.780	0.00	831.764	0.00
0.363	0.00	1.738	1.34	8.318	2.93	39.811	1.59	190.546	0.00	912.011	0.00
0.398	0.00	1.905	1.52	9.120	3.01	43.652	1.31	208.930	0.00	1000.000	0.00
0.437	0.00	2.089	1.69	10.000	3.11	47.863	1.03	229.087	0.00		
0.479	0.00	2.291		10.965		52.481		251.189	0.00		

Operator notes: Sped up both regrind mills



G & T METALLURGICAL SERVICES LTD.



ISO9001:2008
Certificate No. FS63170

Result Analysis Report

Project and Test number:

KM2543-11

Measured by:

Wendy

Measured:

Thursday, February 11, 2010 9:57:54 AM

Sample Name:

Copper Regrind Discharge - Average

Edited by:

Wendy

Analysed:

Thursday, February 11, 2010 9:57:55 AM

Particle Name:

Silica 0.1

Accessory Name:

Hydro 2000MU (A)

Analysis model:

General purpose

Sensitivity:

Normal

Particle RI:

1.544

Absorption:

0.1

Size range:

0.100 to 1000.000 um

Obscuration:

16.76 %

Dispersant Name:

Water

Dispersant RI:

1.330

Weighted Residual:

0.297 %

Result Emulation:

Off

Concentration:

0.0136 %Vol

Span :

3.184

Uniformity:

1.08

Result units:

Volume

Specific Surface Area:

0.428 m²/g

Surface Weighted Mean D[3,2]:

5.286 um

Vol. Weighted Mean D[4,3]:

19.304 um

d(0.1): 2.126 um d(0.5): 12.665 um **d(0.8): 29.037 um** d(0.9): 42.452 um d(0.98): 83.76 um

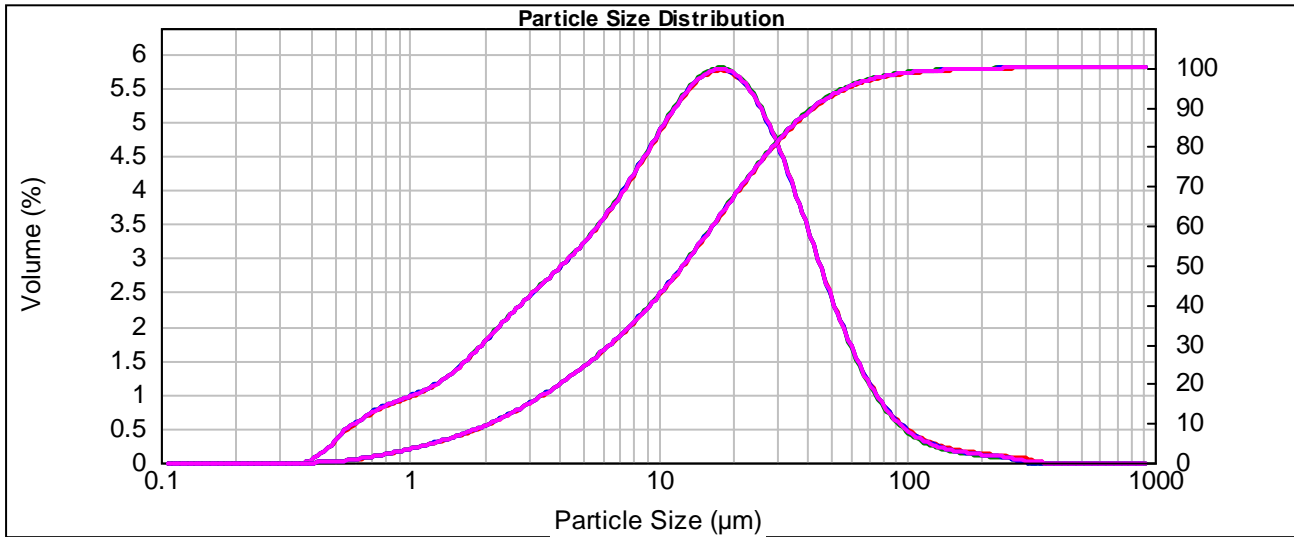

Size (µm)	Volume In %	Size (µm)	Volume In %	Size (µm)	Volume In %	Size (µm)	Volume In %	Size (µm)	Volume In %	Size (µm)	Volume In %
0.100	0.00	0.479	0.18	2.291	1.24	10.965	3.11	52.481	1.22	251.189	0.04
0.110	0.00	0.525	0.29	2.512	1.33	12.023	3.23	57.544	1.01	275.423	0.02
0.120	0.00	0.575	0.34	2.754	1.42	13.183	3.34	63.096	0.82	301.995	0.01
0.132	0.00	0.631	0.40	3.020	1.50	14.454	3.42	69.183	0.66	331.131	0.00
0.145	0.00	0.692	0.46	3.311	1.59	15.849	3.46	75.858	0.53	363.078	0.00
0.158	0.00	0.759	0.50	3.631	1.67	17.378	3.47	83.176	0.41	398.107	0.00
0.174	0.00	0.832	0.53	3.981	1.75	19.055	3.45	91.201	0.33	436.516	0.00
0.191	0.00	0.912	0.57	4.365	1.84	20.893	3.37	100.000	0.26	478.630	0.00
0.209	0.00	1.000	0.60	4.786	1.94	22.909	3.26	109.648	0.20	524.807	0.00
0.229	0.00	1.096	0.64	5.248	2.04	25.119	3.11	120.226	0.16	575.440	0.00
0.251	0.00	1.202	0.68	5.754	2.15	27.542	2.92	131.826	0.13	630.957	0.00
0.275	0.00	1.318	0.74	6.310	2.27	30.200	2.70	144.544	0.11	691.831	0.00
0.302	0.00	1.445	0.80	6.918	2.40	33.113	2.47	158.489	0.09	758.578	0.00
0.331	0.00	1.585	0.88	7.586	2.53	36.308	2.21	173.780	0.08	831.764	0.00
0.363	0.00	1.738	0.97	8.318	2.68	39.811	1.96	190.546	0.07	912.011	0.00
0.398	0.04	1.905	1.06	9.120	2.82	43.652	1.70	208.930	0.06	1000.000	0.00
0.437	0.11	2.089	1.15	10.000	2.97	47.863	1.45	229.087	0.05		
0.479		2.291		10.965		52.481		251.189			

Operator notes:



Result Analysis Report

Project and Test number:

KM2543-12

Measured by:

Justin

Measured:

Thursday, February 11, 2010 3:29:06 PM

Sample Name:

Copper Regrind Discharge - Average

Edited by:

Justin

Analysed:

Thursday, February 11, 2010 3:29:07 PM

Particle Name:

Silica 1.0

Accessory Name:

Hydro 2000MU (A)

Analysis model:

General purpose

Sensitivity:

Normal

Particle RI:

1.544

Absorption:

1

Size range:

0.100 to 1000.000 um

Obscuration:

9.21 %

Dispersant Name:

Water

Dispersant RI:

1.330

Weighted Residual:

0.346 %

Result Emulation:

Off

Concentration:

0.0039 %Vol

Span :

3.740

Uniformity:

1.19

Result units:

Volume

Specific Surface Area:

1.83 m²/g

Surface Weighted Mean D[3,2]:

3.279 um

Vol. Weighted Mean D[4,3]:

13.185 um

d(0.1): 1.239 um d(0.5): 8.350 um **d(0.8): 23.235 um** d(0.9): 32.465 um d(0.98): 49.91 um

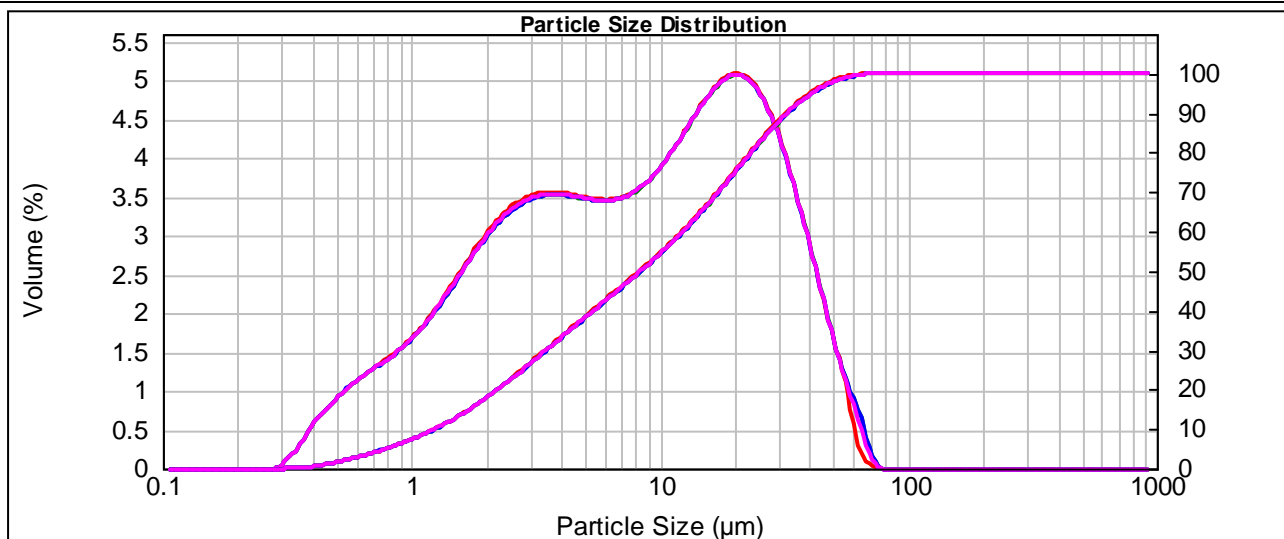

Size (µm)	Volume In %	Size (µm)	Volume In %	Size (µm)	Volume In %	Size (µm)	Volume In %	Size (µm)	Volume In %	Size (µm)	Volume In %
0.100	0.00	0.479	0.55	2.291	1.97	10.965	2.49	52.481	0.72	251.189	0.00
0.110	0.00	0.525	0.62	2.512	2.04	12.023	2.61	57.544	0.48	275.423	0.00
0.120	0.00	0.575	0.68	2.754	2.08	13.183	2.74	63.096	0.25	301.995	0.00
0.132	0.00	0.631	0.73	3.020	2.11	14.454	2.85	69.183	0.03	331.131	0.00
0.145	0.00	0.692	0.79	3.311	2.13	15.849	2.95	75.858	0.00	363.078	0.00
0.158	0.00	0.759	0.84	3.631	2.13	17.378	3.02	83.176	0.00	398.107	0.00
0.174	0.00	0.832	0.90	3.981	2.12	19.055	3.06	91.201	0.00	436.516	0.00
0.191	0.00	0.912	0.97	4.365	2.09	20.893	2.98	100.000	0.00	478.630	0.00
0.209	0.00	1.000	1.05	4.786	2.08	22.909	2.86	109.648	0.00	524.807	0.00
0.229	0.00	1.096	1.13	5.248	2.08	25.119	2.68	120.226	0.00	575.440	0.00
0.251	0.00	1.202	1.24	5.754	2.09	27.542	2.46	131.826	0.00	630.957	0.00
0.275	0.00	1.318	1.35	6.310	2.11	30.200	2.20	144.544	0.00	691.831	0.00
0.302	0.00	1.445	1.46	6.918	2.15	33.113	1.90	158.489	0.00	758.578	0.00
0.331	0.08	1.585	1.58	7.586	2.20	36.308	1.60	173.780	0.00	831.764	0.00
0.363	0.15	1.738	1.70	8.318	2.28	39.811	1.30	190.546	0.00	912.011	0.00
0.398	0.27	1.905	1.80	9.120	2.38	43.652	1.00	208.930	0.00	1000.000	0.00
0.437	0.39	2.089	1.90	10.000	2.38	47.863	1.00	229.087	0.00		
0.479	0.46	2.291	1.90	10.965	2.38	52.481	1.00	251.189	0.00		

Operator notes:



Result Analysis Report

Project and Test number:

KM2543-17

Measured by:

david

Measured:

Wednesday, March 31, 2010 3:29:57 PM

Sample Name:

Copper Regrind Discharge V - Average

Edited by:

david

Analysed:

Wednesday, March 31, 2010 3:29:58 PM

Particle Name:

Silica 0.1

Accessory Name:

Hydro 2000MU (A)

Analysis model:

General purpose

Sensitivity:

Normal

Particle RI:

1.544

Absorption:

0.1

Size range:

0.100 to 1000.000 um

Obscuration:

14.21 %

Dispersant Name:

Water

Dispersant RI:

1.330

Weighted Residual:

0.558 %

Result Emulation:

Off

Concentration:

0.0092 %Vol

Span :

2.938

Uniformity:

0.936

Result units:

Volume

Specific Surface Area:

0.532 m²/g

Surface Weighted Mean D[3,2]:

4.253 um

Vol. Weighted Mean D[4,3]:

13.349 um

d(0.1): 1.654 um d(0.5): 9.674 um **d(0.8): 21.601 um** d(0.9): 30.073 um d(0.98): 49.36 um

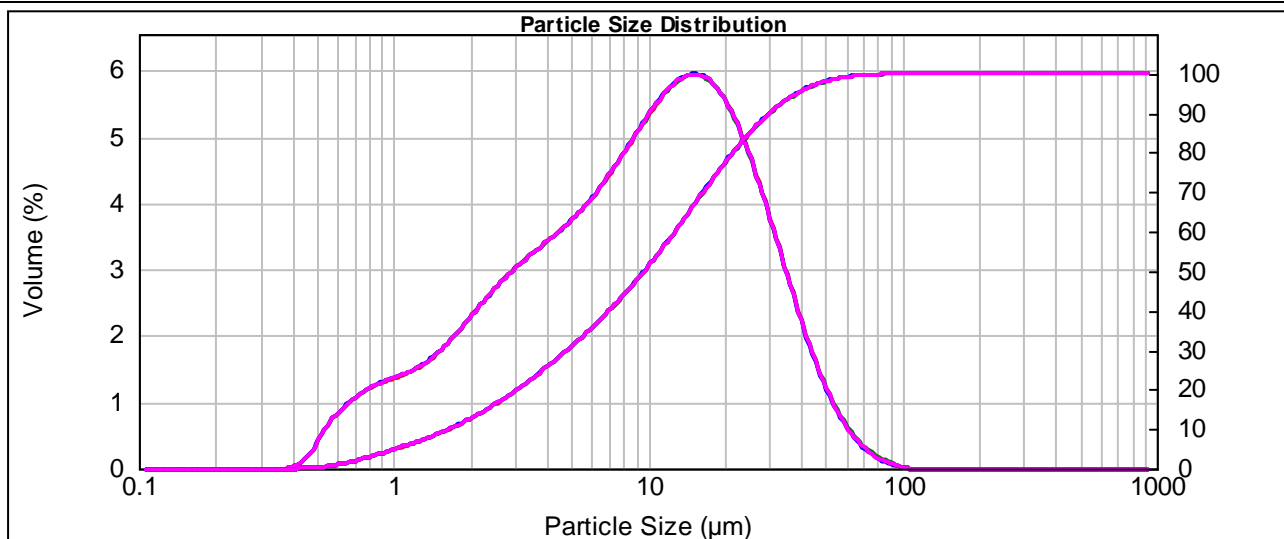

Size (µm)	Volume In %	Size (µm)	Volume In %	Size (µm)	Volume In %	Size (µm)	Volume In %	Size (µm)	Volume In %	Size (µm)	Volume In %
0.100	0.00	0.479	0.23	2.291	1.58	10.965	3.39	52.481	0.54	251.189	0.00
0.110	0.00	0.525	0.40	2.512	1.68	12.023	3.49	57.544	0.38	275.423	0.00
0.120	0.00	0.575	0.49	2.754	1.78	13.183	3.55	63.096	0.26	301.995	0.00
0.132	0.00	0.631	0.58	3.020	1.86	14.454	3.58	69.183	0.17	331.131	0.00
0.145	0.00	0.692	0.67	3.311	1.94	15.849	3.56	75.858	0.10	363.078	0.00
0.158	0.00	0.759	0.72	3.631	2.01	17.378	3.48	83.176	0.06	398.107	0.00
0.174	0.00	0.832	0.77	3.981	2.09	19.055	3.36	91.201	0.03	436.516	0.00
0.191	0.00	0.912	0.80	4.365	2.17	20.893	3.19	100.000	0.00	478.630	0.00
0.209	0.00	1.000	0.84	4.786	2.25	22.909	2.96	109.648	0.00	524.807	0.00
0.229	0.00	1.096	0.87	5.248	2.35	25.119	2.71	120.226	0.00	575.440	0.00
0.251	0.00	1.202	0.92	5.754	2.45	27.542	2.42	131.826	0.00	630.957	0.00
0.275	0.00	1.318	0.98	6.310	2.57	30.200	2.12	144.544	0.00	691.831	0.00
0.302	0.00	1.445	1.06	6.918	2.70	33.113	1.81	158.489	0.00	758.578	0.00
0.331	0.00	1.585	1.15	7.586	2.84	36.308	1.51	173.780	0.00	831.764	0.00
0.363	0.00	1.738	1.26	8.318	2.99	39.811	1.22	190.546	0.00	912.011	0.00
0.398	0.03	1.905	1.37	9.120	3.13	43.652	0.97	208.930	0.00	1000.000	0.00
0.437	0.10	2.089	1.48	10.000	3.27	47.863	0.73	229.087	0.00		
0.479		2.291		10.965		52.481		251.189			

Operator notes:



G & T METALLURGICAL SERVICES LTD.



ISO9001:2008
Certificate No. FS63170

Result Analysis Report

Project and Test number:

KM2543-18

Measured by:

Dean

Measured:

Thursday, April 01, 2010 2:29:57 PM

Sample Name:

Copper Regrind Discharge V - Average

Edited by:

Dean

Analysed:

Thursday, April 01, 2010 2:29:58 PM

Particle Name:

Silica 0.01

Accessory Name:

Hydro 2000MU (A)

Analysis model:

General purpose

Sensitivity:

Normal

Particle RI:

1.544

Absorption:

0.01

Size range:

0.100 to 1000.000 um

Obscuration:

16.16 %

Dispersant Name:

Water

Dispersant RI:

1.330

Weighted Residual:

0.217 %

Result Emulation:

Off

Concentration:

0.0111 %Vol

Span :

3.252

Uniformity:

1.1

Result units:

Volume

Specific Surface Area:

 0.416 m²/g

Surface Weighted Mean D[3,2]:

5.444 um

Vol. Weighted Mean D[4,3]:

15.787 um

d(0.1): 2.188 um d(0.5): 10.132 um **d(0.8): 24.839 um** d(0.9): 35.135 um d(0.98): 58.01 um

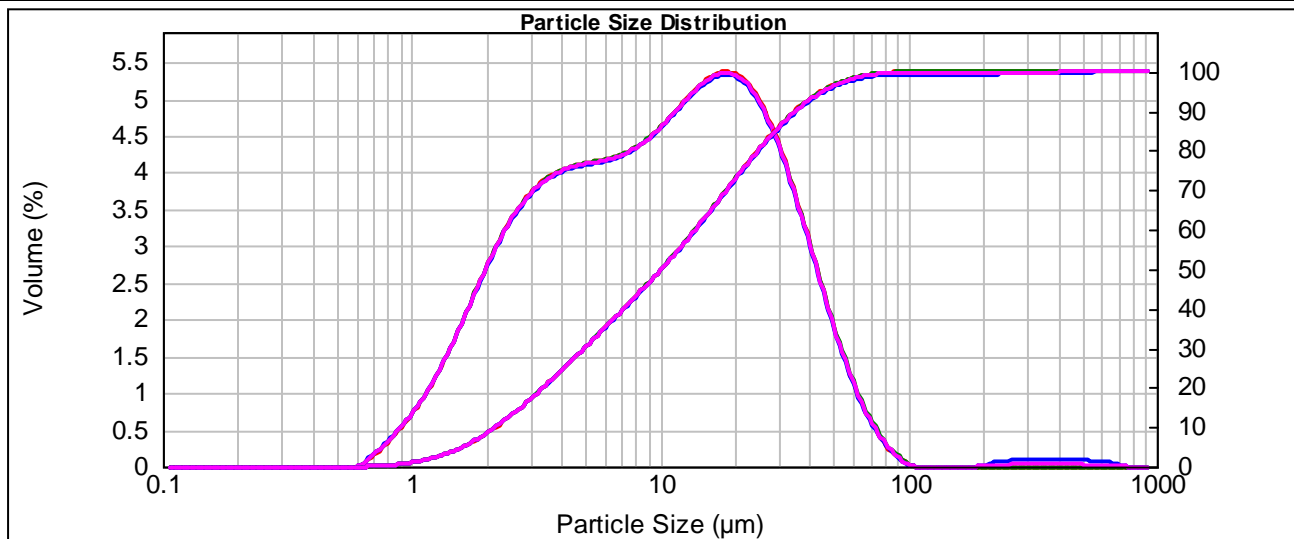

Size (µm)	Volume In %	Size (µm)	Volume In %	Size (µm)	Volume In %	Size (µm)	Volume In %	Size (µm)	Volume In %	Size (µm)	Volume In %
0.100	0.00	0.479	0.00	2.291	1.95	10.965	2.90	52.481	0.90	251.189	0.02
0.110	0.00	0.525	0.00	2.512	2.08	12.023	2.99	57.544	0.68	275.423	0.02
0.120	0.00	0.575	0.00	2.754	2.19	13.183	3.07	63.096	0.49	301.995	0.02
0.132	0.00	0.631	0.05	3.020	2.28	14.454	3.15	69.183	0.33	331.131	0.02
0.145	0.00	0.692	0.12	3.311	2.35	15.849	3.20	75.858	0.21	363.078	0.02
0.158	0.00	0.759	0.19	3.631	2.40	17.378	3.22	83.176	0.12	398.107	0.02
0.174	0.00	0.832	0.29	3.981	2.43	19.055	3.21	91.201	0.04	436.516	0.02
0.191	0.00	0.912	0.37	4.365	2.46	20.893	3.16	100.000	0.00	478.630	0.02
0.209	0.00	1.000	0.48	4.786	2.48	22.909	3.06	109.648	0.00	524.807	0.02
0.229	0.00	1.096	0.60	5.248	2.49	25.119	2.92	120.226	0.00	575.440	0.02
0.251	0.00	1.202	0.74	5.754	2.51	27.542	2.73	131.826	0.00	630.957	0.01
0.275	0.00	1.318	0.90	6.310	2.53	30.200	2.51	144.544	0.00	691.831	0.00
0.302	0.00	1.445	1.07	6.918	2.56	33.113	2.26	158.489	0.00	758.578	0.00
0.331	0.00	1.585	1.26	7.586	2.60	36.308	1.98	173.780	0.00	831.764	0.00
0.363	0.00	1.738	1.44	8.318	2.66	39.811	1.70	190.546	0.00	912.011	0.00
0.398	0.00	1.905	1.62	9.120	2.73	43.652	1.42	208.930	0.01	1000.000	0.00
0.437	0.00	2.089	1.80	10.000	2.81	47.863	1.15	229.087	0.01		
0.479	0.00	2.291		10.965		52.481		251.189			

Operator notes:

APPENDIX IV – KM2543

SPECIAL ASSAY & ABA DATA

INDEX

<u>TABLE</u>	<u>PAGE</u>
IV-1 Replicate Head Assay Data	1
IV-2 Statistical Analysis of Head Assays	2
IV-3 Comparative Copper Concentrate Assays	3
IV-4 Minor Element Assays	4
IV-5 Acid Base Accounting Test Results	5
IV-6 Thickening Test KM2543-18 Copper Concentrate I-V	6
IV-7 Thickening Test KM2543-17 Copper Concentrate IV-V	9
IV-8 Filtering Test KM2543-H Test 18 Copper Concentrate I-V	11
IV-9 Filtering Test KM2543-J Test 17 Copper Concentrate IV-V	12
 <u>FIGURE</u>	
IV-1 Rougher Flotation Test Performance	13

TABLE IV-1
REPLICATE HEAD ASSAY DATA

Sample	Assays - percent or g/tonne								
	Cu	Au	Ag	Fe	Hg	S	C	Cu(Ox)	Cu (CN)
High Gold Copper Ratio East Zone Head 1	2.85	4.64	5.8	5.96	1	3.67	1.49	0.023	0.075
High Gold Copper Ratio East Zone Head 2	2.82	4.84	6.4	5.91	1	3.75	1.80	0.021	0.070
Average	2.84	4.74	6.1	5.94	1	3.71	1.65	0.022	0.073
High Bornite East Zone Head 1	1.41	1.87	6.4	4.61	1	0.85	2.58	0.023	0.883
High Bornite East Zone Head 2	1.47	1.76	6.3	4.62	1	0.85	2.63	0.024	0.991
Average	1.44	1.82	6.4	4.62	1	0.85	2.61	0.024	0.937

TABLE IV-2A
STATISTICAL ANALYSIS OF HEAD ASSAYS
High Gold Copper Ratio East Zone Composite

Test	Assay - percent or grams/tonne					
	Cu	Fe	S	Ag	Au	Hg
1	2.99	6.4	3.92	6	5.60	0.5
3	2.90	6.1	3.60	6	4.95	-
5	2.92	6.2	3.72	6	4.92	-
7	2.99	6.3	3.99	6	5.04	-
9	2.91	6.3	3.89	6	5.01	-
11	3.03	6.2	3.91	6	5.37	-
13	2.87	6.2	3.78	6	5.39	-
17	2.99	6.4	3.79	6	5.49	-
Calculated Head	2.95	6.3	3.82	6	5.22	0.7
Measured Head	2.84	5.9	3.71	6	4.90	-

TABLE IV-2B
STATISTICAL ANALYSIS OF HEAD ASSAYS
High Bornite East Zone Composite

Test	Assay - percent or grams/tonne					
	Cu	Fe	S	Ag	Au	Hg
2	1.42	5.2	0.83	7	2.58	1.0
4	1.43	4.9	0.80	7	2.14	-
6	1.38	4.8	0.86	7	2.48	-
8	1.39	4.9	0.85	7	2.20	-
10	1.47	4.9	0.85	7	2.13	-
12	1.24	4.8	0.70	6	2.14	-
14	1.39	5.0	0.88	6	2.18	-
18	1.44	4.7	0.81	7	2.26	-
Calculated Head	1.40	4.9	0.82	7	2.26	0.8
Measured Head	1.44	4.6	0.85	6	1.95	-

TABLE IV-3
COMPARATIVE COPPER CONCENTRATE ASSAYS

Test	Copper - percent	
	AAS	Titre
3	28.4	28.7
4	49.7	49.6
7	30.6	31.5
8	45.8	47.0
9	32.4	32.9
10	51.0	50.0
11	31.9	32.9
12	48.8	50.0
17 Cu Con I	30.3	31.9
II	28.5	29.8
III	28.9	29.5
IV	29.2	29.2
V	27.2	27.5
18 Cu Con I	50.2	49.8
II	49.2	49.0
III	48.1	48.2
IV	49.5	49.2
V	48.6	48.5

TABLE IV-4
MINOR ELEMENT ASSAYS
Copper Concentrate IV+V

Element	Symbol	Units	Test 17	Test 18
			High Au:Cu Ratio East Zone	High Bornite East Zone
Aluminum	Al	%	0.25	0.51
Antimony	Sb	g/t	56	528
Arsenic	As	g/t	176	154
Bismuth	Bi	g/t	118	87
Cadmium	Cd	g/t	6	4
Calcium	Ca	%	0.24	0.52
Cobalt	Co	g/t	72	28
Copper	Cu	%	28.4	49.0
Fluorine	F	g/t	48	44
Gold	Au	g/t	46.1	71.1
Iron	Fe	%	30.3	16.4
Lead	Pb	%	0.02	0.02
Magnesium	Mg	%	0.16	0.20
Mercury	Hg	g/t	1.2	1.1
Manganese	Mn	%	0.004	0.007
Molybdenum	Mo	%	0.037	0.004
Nickel	Ni	g/t	94	78
Phosphorus	P	g/t	33	36
Selenium	Se	g/t	152	323
Silicon	Si	%	1.5	2.0
Silver	Ag	g/t	41	226
Sulphur	S	%	31.8	25.3
Zinc	Zn	%	0.02	0.02

TABLE IV-5
ACID BASE ACCOUNTING TEST RESULTS

Test Type	Symbol	Rougher Tails IV & V		NBM-1 Pulp Standard
		Test 17	Test 18	
Sulphide + Sulphate content	S(S)	0.11	0.09	0.33
Sulphate content	S(SO ₄)	0.03	0.03	0.02
Neutralization Potential	NP	67.2	149	47.0
Maximum Potential Acidity	MPA	2.50	1.75	9.44
Net Neutralization Potential	NNP	64.7	147	37.6
Neutralization Potential Ratio	NPR	26.9	85.0	4.98
Fizz Test (% CO ₂)	-	3.02	7.03	1.01

TABLE IV-6A
KM2543-F
KM2543-18 Copper Concentrate I-V

SETTLING DATA

Elapsed Time (min)	Interface Height (ml)	Interface Height (mm)
0	1000	357
1	840	300
2	670	239
3	480	171
4	330	118
5	250	89
10	100	36
20	75	27
60	75	27
120	75	27
1440	75	27

Note: Overflow Clarity Poor until 10 mins

Note: Overflow Clarity Fair until 20 mins

Note: Overflow Clarity Good after 20 mins

Note: Very difficult to determine interface until "Fair" clarity.

TEST CONDITIONS

Solids S.G.	4.01
Solids Weight (g)	120
Solids Volume (ml)	29.9
pH (as tested)	11.8
pH modifier (g/T)	5800
Flocculant Type	Superfloc A-130
Flocculant (g/T)	0
Temperature (C)	22
Slurry Volume (ml)	1000
Slurry S.G.	1.09
Final Slurry Volume	75
Initial Percent Solids	11.0
Final Percent Solids	72.7
Thickener Area - m ² /d/tonne	1.4603
U/F Density - percent solids	48.0

Note: Thickener area estimated using the Talmadge-Fitch Method

SETTLING RATE

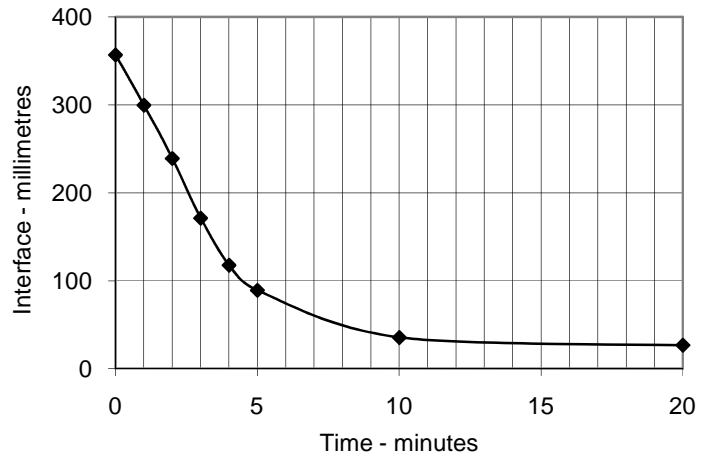

TABLE IV-6B
KM2543-G
KM2543-18 Copper Concentrate I-V

SETTLING DATA

Elapsed Time (min)	Interface Height (ml)	Interface Height (mm)
0	1000	357
0.25	950	339
0.5	890	317
0.75	830	296
1	730	260
1.25	650	232
1.5	540	193
1.75	460	164
2	360	128
3	155	55
4	135	48
5	120	43
10	95	34
20	85	30
60	85	30
120	85	30
1440	85	30

Note: Overflow Clarity Poor until 2 mins

Note: Overflow Clarity Fair until 10 mins

Note: Overflow Clarity Good after 10 mins

Note: Very difficult to determine interface until "Fair" clarity.

TEST CONDITIONS

Solids S.G.	4.05
Solids Weight (g)	120
Solids Volume (ml)	29.6
pH (as tested)	11.8
pH modifier (g/T)	5800
Flocculant Type	Superfloc A-130
Flocculant (g/T)	2
Temperature (C)	22
Slurry Volume (ml)	1000
Slurry S.G.	1.09
Final Slurry Volume	85
Initial Percent Solids	11.0
Final Percent Solids	68.4
Thickener Area - m ² /d/tonne	0.0491
U/F Density - percent solids	50.0

Note: Thickener area estimated using the Talmadge-Fitch Method

SETTLING RATE

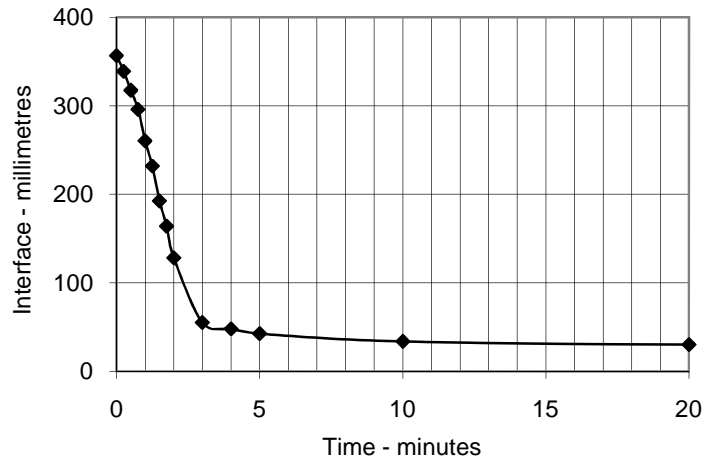

TABLE IV-6C
KM2543-H
KM2543-18 Copper Concentrate I-V

SETTLING DATA

Elapsed Time (min)	Interface Height (ml)	Interface Height (mm)
0	1000	357
0.17	970	346
0.33	890	317
0.5	780	278
0.67	660	235
0.83	530	189
1	480	171
1.25	290	103
1.5	185	66
1.75	175	62
2	170	61
2.5	160	57
3	150	53
4	130	46
5	120	43
10	100	36
20	90	32
60	90	32
120	90	32
1440	90	32

Note: Overflow Clarity Poor until 2.5 mins

Note: Overflow Clarity Fair until 10 mins

Note: Overflow Clarity Good after 10 mins

Note: Very difficult to determine interface until "Fair" clarity.

TEST CONDITIONS

Solids S.G.	4.5188
Solids Weight (g)	120
Solids Volume (ml)	26.6
pH (as tested)	11.8
pH modifier (g/T)	5800
Flocculant Type	Superfloc A-130
Flocculant (g/T)	5
Temperature (C)	22
Slurry Volume (ml)	1000
Slurry S.G.	1.09
Final Slurry Volume	90
Initial Percent Solids	11.0
Final Percent Solids	65.4
Thickener Area - m ² /d/tonne	0.2587
U/F Density - percent solids	64.0

Note: Thickener area estimated using the Talmadge-Fitch Method

SETTLING RATE

TABLE IV-7A
KM2543-I
KM2543-17 Copper Concentrate IV-V

SETTLING DATA

Elapsed Time (min)	Interface Height (ml)	Interface Height (mm)
0	1000	357
0.25	960	342
0.5	930	332
0.75	880	314
1	830	296
1.25	760	271
1.5	720	257
1.75	660	235
2	615	219
3	340	121
4	290	103
5	255	91
10	185	66
20	150	53
60	120	43
120	115	41
1440	115	41

Note: Overflow Clarity Poor until 1 mins

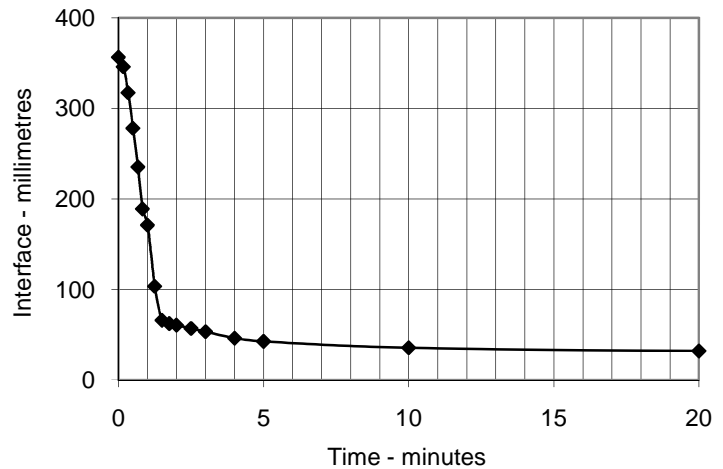
Note: Overflow Clarity Fair until 10 mins

Note: Overflow Clarity Good after 10 mins

TEST CONDITIONS

Solids S.G.	4.055333333
Solids Weight (g)	149.9
Solids Volume (ml)	37.0
pH (as tested)	11.6
pH modifier (g/T)	4667
Flocculant Type	Superfloc A-130
Flocculant (g/T)	2
Temperature (C)	22
Slurry Volume (ml)	1000
Slurry S.G.	1.11
Final Slurry Volume	115
Initial Percent Solids	13.5
Final Percent Solids	65.8
Thickener Area - m ² /d/tonne	0.2241
U/F Density - percent solids	55.0

Note: Thickener area estimated using the Talmadge-Fitch Method

SETTLING RATE

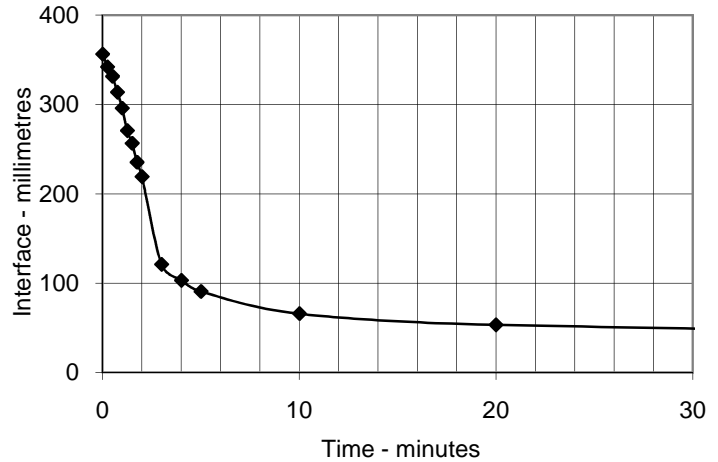

TABLE IV-7B
KM2543-J
KM2543-17 Copper Concentrate IV-V

SETTLING DATA

Elapsed Time (min)	Interface Height (ml)	Interface Height (mm)
0	1000	357
0.17	950	339
0.33	900	321
0.5	880	314
0.67	840	300
0.83	830	296
1	780	278
1.25	720	257
1.5	655	234
1.75	590	210
2	500	178
2.5	340	121
3	275	98
4	240	86
5	220	78
10	170	61
20	130	46
60	105	37
120	105	37
1440	105	37

Note: Overflow Clarity Poor until 2.5 mins

Note: Overflow Clarity Fair until 20 mins

Note: Overflow Clarity Good after 20 mins

Note: Very difficult to determine interface until "Fair" clarity.

TEST CONDITIONS

Solids S.G.	4.055
Solids Weight (g)	137.3
Solids Volume (ml)	33.9
pH (as tested)	11.6
pH modifier (g/T)	4667
Flocculant Type	Superfloc A-130
Flocculant (g/T)	5
Temperature (C)	22
Slurry Volume (ml)	1000
Slurry S.G.	1.10
Final Slurry Volume	105
Initial Percent Solids	12.5
Final Percent Solids	65.9
Thickener Area - m ² /d/tonne	0.2262
U/F Density - percent solids	55.0

Note: Thickener area estimated using the Talmadge-Fitch Method

SETTLING RATE

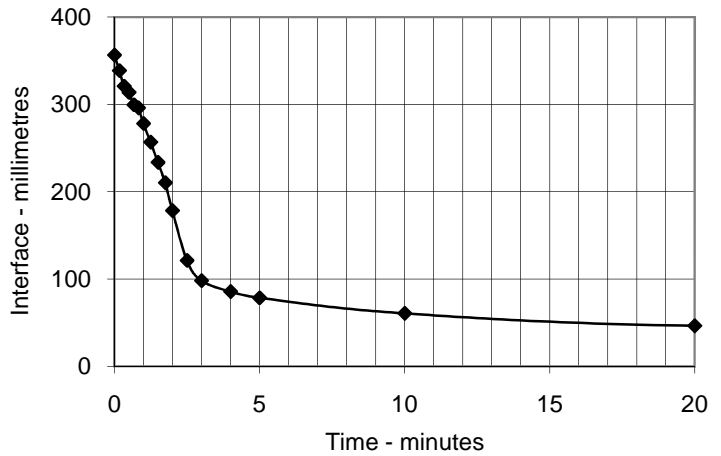

TABLE IV-8
FILTERING TEST RESULTS

PROJECT NO: KM2543-K

PURPOSE: Investigate Filtering Performance on Copper Concentrates.

PROCEDURE: Perform a standard filtration test procedure.

FEED: KM2543-H Test 18 Copper Concentrate I-V.

CONDITIONS:

Parameter	Units	Value
pH	-	12.0
Solids S.G.	-	4.06
Particle Size K ₈₀	μm	22
Filter Area	cm ²	75.4
Filter Media	-	No.3 Whatman
Filtration Rate	ml/sec	7.8
Estimated Sample Weight	g	112
Pulp Density	%	50%
Dry Weight	g	112.9
Vacuum	inch Hg	-22
Filtrate Clarity	-	fair

Time (seconds)			Filter Cake			
Pick Up	Dry	Total	Total Weight (g)	Water (g)	Moisture (%)	Thickness (cm)
90	0	90	136.7	23.8	21.1	0.8
	10	100	135.0	22.1	19.6	
	10	110	133.9	21.0	18.6	
	10	120	133.6	20.7	18.3	
	10	130	133.3	20.4	18.1	
	10	140	133.1	20.2	17.9	
	10	150	133.0	20.1	17.8	

TABLE IV-9
FILTERING TEST RESULTS

PROJECT NO: KM2543-L

PURPOSE: Investigate Filtering Performance on Copper Concentrates.

PROCEDURE: Perform a standard filtration test procedure.

FEED: KM2543-J Test 17 Copper Concentrate IV-V.

CONDITIONS:

Parameter	Units	Value
pH	-	12.0
Solids S.G.	-	4.52
Particle Size K ₈₀	µm	25
Filter Area	cm ²	75.4
Filter Media	-	No.3 Whatman
Filtration Rate	ml/sec	12.3
Estimated Sample Weight	g	114
Pulp Density	%	50%
Dry Weight	g	114.40
Vacuum	inch Hg	-22
Filtrate Clarity	-	good

Time (seconds)			Filter Cake			
Pick Up	Dry	Total	Total Weight (g)	Water (g)	Moisture (%)	Thickness (cm)
97	0	97	140.0	25.6	22.4	
	10	107	139.3	24.9	21.8	
	10	117	139.0	24.6	21.5	
	10	127	138.5	24.1	21.1	
	10	137	138.2	23.8	20.8	
	10	147	138.0	23.6	20.6	
	10	157	137.9	23.5	20.5	

**FIGURE IV-1
ROUGHER TEST PERFORMANCE DATA**

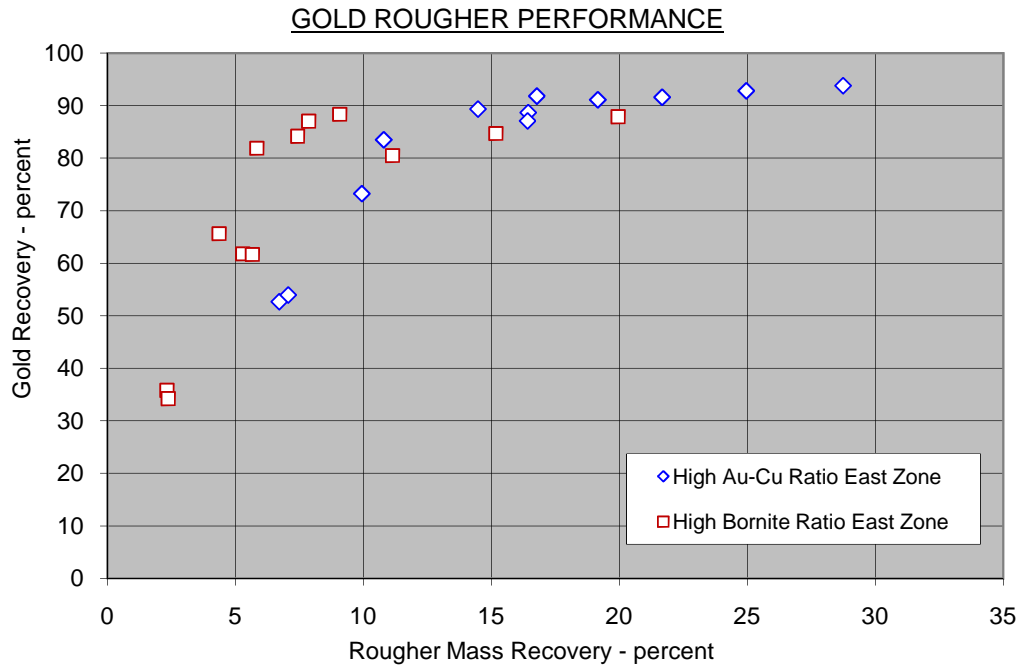
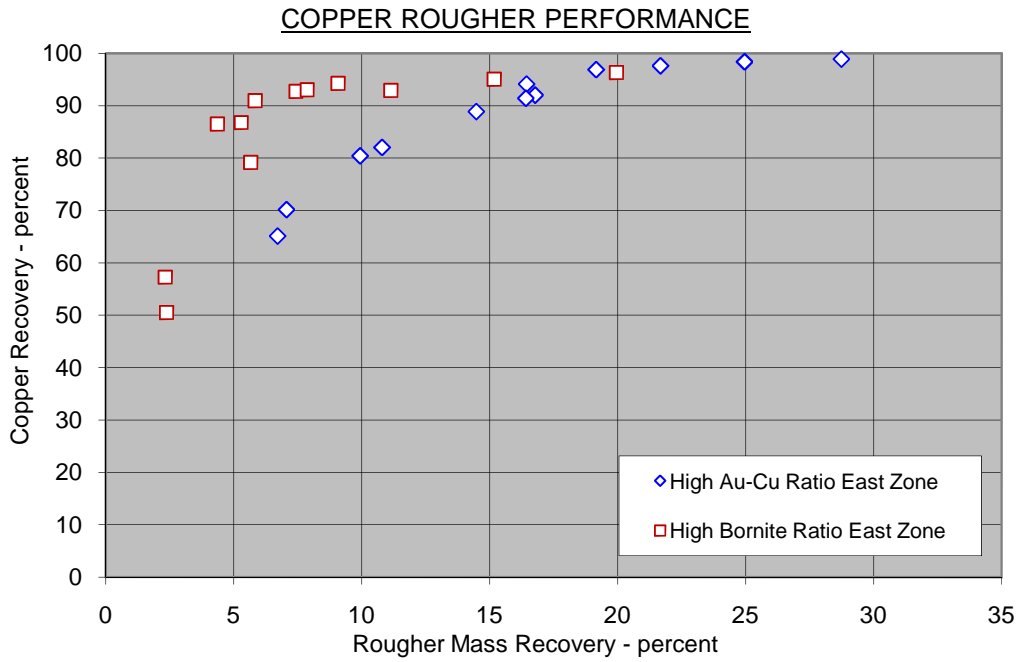

Notes: Detailed test results can be located in Appendix II.

APPENDIX V – KM2543

MODAL ANALYSIS DATA

INDEX

<u>TABLE</u>		<u>PAGE</u>
1	High Gold Copper Ratio East Zone, 157 μ m K ₈₀	1
2	High Bornite East Zone, 154 μ m K ₈₀	5

TABLE 1A
SUMMARY OF PERCENT LIBERATION BY SIZE AND CLASS
High Gold Copper Ratio East Zone, 157µm K80
KM2543

Size Range	>150µm					<150>53µm					<53µm>C4				
Mineral Status	Cp	Bn	Ch	Py	Gn	Cp	Bn	Ch	Py	Gn	Cp	Bn	Ch	Py	Gn
Liberated	1.3	0.0	0.0	6.7	21.0	23.0	0.0	0.0	20.2	42.2	25.1	12.0	0.0	8.9	14.5
Binary - Cp		54.0	0.0	4.1	1.7		0.0	0.0	11.7	1.9		12.0	1.7	6.9	0.4
Binary - Bn	0.0		0.0	0.0	0.0	1.4		0.0	0.0	0.0	0.7		3.3	0.0	0.0
Binary - Ch	0.0	0.0		0.0	0.0	0.0	0.0		0.0	0.0	0.0	0.0		0.0	0.0
Binary - Py	0.3	0.0	0.0		0.2	0.6	0.0	0.0		0.3	0.5	0.0	0.0		0.1
Binary - Gn	8.2	0.0	0.3	13.1		16.9	0.0	2.1	13.5		3.2	0.0	0.0	2.4	
Multiphase	0.2	0.0	0.0	0.7	0.0	0.6	0.6	0.0	4.0	0.1	0.2	4.8	5.0	1.1	0.0
Total	10.0	54.0	0.3	24.7	23.0	42.5	0.6	2.1	49.4	44.5	29.7	28.9	10.0	19.3	14.9

Size Range	<C4>C5					<C5				
Mineral Status	Cp	Bn	Ch	Py	Gn	Cp	Bn	Ch	Py	Gn
Liberated	3.8	0.6	3.4	1.0	3.0	12.5	1.5	12.5	2.7	14.3
Binary - Cp		1.7	0.0	0.4	0.0		4.5	0.0	0.9	0.2
Binary - Bn	0.1		10.2	0.0	0.0	0.3		37.5	0.0	0.0
Binary - Ch	0.0	1.1		0.0	0.0	0.0	3.0		0.0	0.0
Binary - Py	0.0	0.0	0.0		0.0	0.1	0.0	0.0		0.0
Binary - Gn	0.2	0.6	0.0	0.4		0.7	1.5	0.0	1.0	
Multiphase	0.0	0.6	5.1	0.1	0.0	0.1	1.5	18.7	0.2	0.0
Total	4.1	4.5	18.8	1.8	3.0	13.7	12.0	68.7	4.8	14.6

SUMMARY OF MINERAL DISTRIBUTION BY CLASS OF ASSOCIATION

Mineral Status	Mineral Liberation-2 Dimensions					Mineral Liberation-3 Dimensions				
	Cp	Bn	Ch	Py	Gn	Cp	Bn	Ch	Py	Gn
Liberated	65.7	14.1	15.9	39.5	95.0	57.2	0.0	0.0	24.4	93.8
Binary - Cp		72.2	1.7	24.0	4.2		84.0	2.0	29.9	5.3
Binary - Bn	2.5		51.1	0.0	0.0	3.1		60.7	0.0	0.0
Binary - Ch	0.0	4.1		0.0	0.0	0.0	4.8		0.0	0.0
Binary - Py	1.5	0.0	0.0		0.6	1.9	0.0	0.0		0.8
Binary - Gn	29.2	2.1	2.5	30.3		36.5	2.4	3.0	37.9	
Multiphase	1.0	7.5	28.9	6.2	0.1	1.3	8.7	34.3	7.7	0.1
Total	100	100	100	100	100	100	100	100	100	100

Notes 1) Cp-Chalcopyrite, Bn-Bornite, Ch-Chalcocite and Covellite,

Py-Pyrite, Gn-Non-Sulphide Minerals.

2) 0.0 Indicates these minerals were not observed during the counting procedure.

3) The 150 and 53µm sizing fractions correspond to the Tyler 100 and 270 mesh sieves.

C1 to C5 indicates cyclones 1 to 5 on the cyclosizer.

4) Because the <C5 fraction is not measured an overall estimate is calculated by the QEMSCAN.

5) The Total line is the distribution of mineral in the size fraction. Original data is from the size by assay and distribution tables.

6) The calculated liberation of the unsized product as measured in two dimensions has been converted to three dimensions using correction factors developed by G & T Metallurgical Services.

7) The three dimension liberation is zero if the liberation in two dimensions is less than 20 percent.

TABLE 1B
SIZE BY ASSAY AND DISTRIBUTION BASED ON METAL CONTENT
High Gold Copper Ratio East Zone, 157µm K80

Size Fraction	Mass %	Assays-percent					Distribution				
		Cu	Fe	S			Cu	Fe	S		
>150µm	21.9	1.39	4.57	2.84			10.1	15.4	13.4		
<150>53µm	44.4	2.82	5.64	4.51			41.5	38.6	43.0		
<53µm>C4	16.3	5.41	9.20	7.89			29.3	23.1	27.6		
<C4>C5	3.1	3.98	7.90	5.04			4.1	3.8	3.4		
<C5	14.3	3.16	8.60	4.13			15.0	19.0	12.7		
Total	100	3.01	6.48	4.66			100	100	100		

TABLE 1C
SIZE BY ASSAY AND DISTRIBUTION BASED ON MINERAL CONTENT
High Gold Copper Ratio East Zone, 157µm K80

Size Fraction	Mass %	Assays-percent					Distribution				
		Cp	Bn	Ch	Py	Gn	Cp	Bn	Ch	Py	Gn
>150µm	21.9	3.9	0.06	0.00	2.83	93.2	10.0	54.0	0.3	24.7	23.0
<150>53µm	44.4	8.1	0.00	0.00	2.80	89.1	42.5	0.6	2.1	49.4	44.5
<53µm>C4	16.3	15.5	0.05	0.06	2.98	81.4	29.7	28.9	10.0	19.3	14.9
<C4>C5	3.1	11.3	0.04	0.56	1.47	86.6	4.1	4.5	18.8	1.8	3.0
<C5	14.3	8.1	0.02	0.44	0.84	90.6	13.7	12.0	68.7	4.8	14.6
Total	100	8.5	0.03	0.09	2.52	88.9	100	100	100	100	100

Notes: 1) Cp-Chalcopyrite, Bn-Bornite, Ch-Chalcocite and Covellite,
Py-Pyrite, Gn-Non-Sulphide Minerals.

- 2) Mineral assays are based on gravimetric factors to convert the metal to the pure mineral.
- 3) See appendix I for details of gravimetric factors.
- 4) An assay value of "0" indicates the assay value is less than the detection limit.

TABLE 1D
ESTIMATED RELATIVE PROPORTION AND COMPOSITION OF MINERAL GRAINS
High Gold Copper Ratio East Zone, 157µm K80

Binary Component	Proportion by Weight-2D					Proportion by Weight-3D					Composition of Grains				
	Cp	Bn	Ch	Py	Gn	Cp	Bn	Ch	Py	Gn	Cp	Bn	Ch	Py	Gn
Liberated	5.58	0.00	0.01	0.99	84.4	4.85	0.00	0.00	0.61	83.3	100	100	100	100	100
Binary - Cp		0.02	0.00	0.60	3.8		0.02	0.00	0.75	4.7		8	37	82	60
Binary - Bn	0.21		0.05	0.00	0.0	0.26		0.06	0.00	0.0	92		98	0	81
Binary - Ch	0.00	0.00		0.00	0.0	0.00	0.00		0.00	0.0	63	2		0	73
Binary - Py	0.13	0.00	0.00		0.6	0.16	0.00	0.00		0.7	18	0	0		43
Binary - Gn	2.48	0.00	0.00	0.76		3.10	0.00	0.00	0.95		40	19	27	57	
Multiphase	0.09	0.00	0.03	0.16	0.1	0.11	0.00	0.03	0.19	0.1	24	0	7	42	27
Average Composition	8.49	0.03	0.09	2.52	88.9	8.49	0.03	0.09	2.52	88.9	59	3	17	69	95

- Notes 1) The two-dimensional proportion of minerals is a weighted estimate which is based on the liberation and the mineral content of the unsized sample.
- 2) The three-dimensional data is based on converting the two dimensional liberation data using G & T Metallurgical Services correction factors.
- 3) Composition values of "0" represents values <2% and "100" represents values >98%.

TABLE 1E
DISTRIBUTION BY SIZE RANGE OF COPPER SULPHIDES MINERALS
High Gold Copper Ratio East Zone, 157µm K80

Size Fraction	Mass %	% Copper Bearing Minerals						% Copper of Total Copper						% Iron of Total Iron			
		Cp	Bn	Ch	Cv	Te	En	Cp	Bn	Ch	Cv	Te	En	Cs	Py	Goe	Gn
>150µm	21.9	98.3	1.6	0.0	0.0	0.0	0.0	97.0	3.0	0.0	0.0	0.0	0.0	20.8	28.8	22.5	27.8
<150>53µm	44.4	100	0.0	0.0	0.0	0.0	0.0	99.9	0.0	0.1	0.0	0.0	0.0	42.1	23.1	17.4	17.4
<53µm>C4	16.3	99.6	0.3	0.0	0.0	0.0	0.0	99.3	0.5	0.1	0.0	0.0	0.0	54.8	15.1	14.8	15.3
<C4>C5	3.1	99.3	0.3	0.3	0.1	0.0	0.0	98.5	0.6	0.6	0.2	0.0	0.0	49.0	8.7	18.9	23.4
<C5	14.3	94.6	0.3	3.5	1.6	0.0	0.0	90.3	0.4	6.3	3.0	0.0	0.0	32.4	4.5	34.5	28.6
Total	100	98.8	0.5	0.5	0.2	0.0	0.0	97.8	0.8	1.0	0.4	0.0	0.0	0.0	0.0	0.0	0.0

- Notes 1) Cp-Chalcocopyrite, Bn-Bornite, Ch-Chalcocite, Cv-Covellite, Te-Tetrahedrite/Tennantite Group Minerals, En-Enargite.
Cs-Chalcocopyrite and Bornite, Py-Pyrite, Goe-Goethite, Magnetite and Hematite, Gn-Non-Sulphide Minerals

TABLE 1F
COMPARATIVE ASSAY TABLE
High Gold Copper Ratio East Zone, 157µm K80

Methods	Cu	Fe	S
QEMSCAN	3.1	6.6	4.6
Chemical	3.0	6.5	4.7

- Notes 1) This table compares the chemical composition of the samples determined by chemical analysis with the composition determined by QEMSCAN analysis.

TABLE 1G
THE WEIGHT OF THE OBSERVED MINERALS
High Gold Copper Ratio East Zone, 157µm K80

Mineral	Mineral Assays (percent)					Total
	>150µm	<150>75µm	<75µm>C2	<C2>C5	<C5	
Chalcopyrite	3.29	8.04	17.1	11.8	8.61	8.67
Bornite	0.05	0.00	0.05	0.04	0.02	0.03
Chalcocite	0.00	0.00	0.01	0.03	0.32	0.05
Covellite	0.00	0.00	0.00	0.01	0.15	0.02
Tetrahedrite	0.00	0.00	0.01	0.01	0.00	0.00
Energite	0.00	0.00	0.00	0.00	0.00	0.00
Molybdenite	0.00	0.02	0.02	0.06	0.00	0.01
Pyrite	3.00	2.89	3.1	1.36	0.80	2.60
Iron Oxides	2.07	1.82	2.63	2.60	4.36	2.39
Quartz	63.7	68.9	53.6	49.7	42.6	60.9
Micas	14.2	8.97	10.3	17.6	6.73	10.3
Ankerite	8.02	6.10	8.85	10.6	9.12	7.54
Feldspars	3.48	1.79	1.97	3.37	4.19	2.58
Ti Mineral Group	0.19	0.12	0.28	0.40	2.37	0.49
Apatite	0.09	0.10	0.17	0.32	0.00	0.10
Amphibole	0.47	0.21	0.24	0.22	0.13	0.26
Calcite	0.09	0.08	0.18	0.20	5.24	0.84
Dolomite	0.27	0.15	0.42	0.49	3.67	0.74
Garnet	0.17	0.10	0.10	0.10	1.14	0.26
Kaolinite (clay)	0.06	0.14	0.08	0.08	2.55	0.45
Barite	0.08	0.07	0.33	0.26	0.38	0.17
Pyroxene	0.16	0.14	0.10	0.12	0.34	0.16
Chlorite	0.01	0.01	0.02	0.05	0.23	0.04
Epidote	0.01	0.01	0.00	0.00	1.72	0.25
Alunite	0.03	0.02	0.02	0.02	1.07	0.17
Tourmaline	0.01	0.01	0.02	0.04	1.73	0.26
Others	0.52	0.31	0.46	0.55	2.56	0.71
Total	100	100	100	100	100	100

- Note: 1) Iron Oxides includes Hematite, Magnetite, Hematite and Goethite.
2) Feldspar includes K-Feldspar, Feldspar-Albite and Alkali-Feldspar.
3) Micas-Muscovite, Biotite and Plogopite.
4) Ti-Minerals: Rutile/Anatase, Ilmenite and Sphene.
5) Garnet-Andradite, Grossular and Almandine.
6) Others includes trace amount of Sphalerite and unresolved mineral species.

TABLE 2A
SUMMARY OF PERCENT LIBERATION BY SIZE AND CLASS
High Bornite East Zone, 154µm K80
KM2543

Size Range	>150µm					<150>53µm					<53µm>C4				
Mineral Status	Cp	Bn	Ch	Py	Gn	Cp	Bn	Ch	Py	Gn	Cp	Bn	Ch	Py	Gn
Liberated	0.5	0.2	0.0	1.6	20.7	6.0	15.4	0.0	3.0	35.8	12.9	22.4	0.7	12.6	16.7
Binary - Cp		0.1	0.0	1.6	0.5		4.3	0.0	4.0	0.4		4.2	0.0	5.0	0.1
Binary - Bn	0.3		0.0	0.0	0.2	6.0		9.6	0.0	0.3	7.2		31.6	1.0	0.1
Binary - Ch	0.0	0.0		0.0	0.0	0.0	0.0		0.0	0.0	0.0	0.7		0.0	0.0
Binary - Py	0.0	0.0	0.0		0.0	0.5	0.0	0.0		0.1	0.2	0.0	0.0		0.0
Binary - Gn	12.9	6.7	1.3	1.6		17.3	18.1	0.0	14.0		7.9	5.5	0.0	25.7	
Multiphase	2.6	0.9	0.0	0.0	0.1	5.5	2.0	9.6	2.0	0.0	4.2	1.2	7.3	1.5	0.0
Total	16.4	7.9	1.3	4.9	21.4	35.5	39.8	19.2	23.0	36.6	32.3	34.1	39.7	45.9	17.0

Size Range	<C4>C5					<C5				
Mineral Status	Cp	Bn	Ch	Py	Gn	Cp	Bn	Ch	Py	Gn
Liberated	3.3	2.5	0.0	1.1	3.4	5.9	9.5	0.0	6.6	21.3
Binary - Cp		0.7	0.1	0.2	0.0		2.9	0.5	1.3	0.1
Binary - Bn	1.3		7.4	0.0	0.0	2.3		26.3	0.0	0.1
Binary - Ch	0.0	0.2		0.0	0.0	0.0	0.6		0.0	0.0
Binary - Py	0.0	0.0	0.0		0.0	0.1	0.0	0.0		0.1
Binary - Gn	0.7	0.3	0.3	2.3		1.2	1.1	1.0	14.2	
Multiphase	0.4	0.1	0.9	0.1	0.0	0.7	0.4	3.3	0.4	0.0
Total	5.7	3.8	8.8	3.7	3.5	10.2	14.5	31.1	22.4	21.5

SUMMARY OF MINERAL DISTRIBUTION BY CLASS OF ASSOCIATION

Mineral Status	Mineral Liberation-2 Dimensions					Mineral Liberation-3 Dimensions				
	Cp	Bn	Ch	Py	Gn	Cp	Bn	Ch	Py	Gn
Liberated	28.6	50.0	0.7	25.0	97.8	10.7	37.5	0.0	6.2	97.3
Binary - Cp		12.2	0.6	12.1	1.2		15.2	0.6	15.2	1.5
Binary - Bn	17.1		74.9	1.0	0.6	21.4		75.5	1.3	0.8
Binary - Ch	0.0	1.5		0.0	0.0	0.0	1.9		0.0	0.0
Binary - Py	0.8	0.0	0.0		0.2	1.0	0.0	0.0		0.2
Binary - Gn	40.1	31.7	2.5	57.9		50.1	39.6	2.5	72.4	
Multiphase	13.4	4.6	21.2	3.9	0.2	16.7	5.7	21.4	4.9	0.2
Total	100	100	100	100	100	100	100	100	100	100

Notes 1) Cp-Chalcopyrite, Bn-Bornite, Ch-Chalcocite and Covellite,

Py-Pyrite, Gn-Non-Sulphide Minerals.

2) 0.0 Indicates these minerals were not observed during the counting procedure.

3) The 150 and 53µm sizing fractions correspond to the Tyler 100 and 270 mesh sieves.

C1 to C5 indicates cyclones 1 to 5 on the cyclosizer.

4) Because the <C5 fraction is not measured an overall estimate is calculated by the QEMSCAN.

5) The Total line is the distribution of mineral in the size fraction. Original data is from the size by assay and distribution tables.

6) The calculated liberation of the unsized product as measured in two dimensions has been converted to three dimensions using correction factors developed by G & T Metallurgical Services.

7) The three dimension liberation is zero if the liberation in two dimensions is less than 20 percent.

TABLE 2B
SIZE BY ASSAY AND DISTRIBUTION BASED ON METAL CONTENT
High Bornite East Zone, 154µm K80

Size Fraction	Mass %	Assays-percent					Distribution				
		Cu	Fe	S			Cu	Fe	S		
>150µm	21.1	0.63	3.84	0.42			9.0	16.7	8.6		
<150>53µm	36.6	1.56	4.57	1.01			38.9	34.5	36.1		
<53µm>C4	17.5	2.83	7.30	1.95			33.7	26.3	33.3		
<C4>C5	3.5	1.70	4.94	1.17			4.0	3.6	4.0		
<C5	21.3	0.99	4.32	0.87			14.3	19.0	18.0		
Total	100	1.47	4.85	1.02			100	100	100		

TABLE 2C
SIZE BY ASSAY AND DISTRIBUTION BASED ON MINERAL CONTENT
High Bornite East Zone, 154µm K80

Size Fraction	Mass %	Assays-percent					Distribution				
		Cp	Bn	Ch	Py	Gn	Cp	Bn	Ch	Py	Gn
>150µm	21.1	0.44	0.74	0.00	0.06	98.8	16.4	7.9	1.3	4.9	21.4
<150>53µm	36.6	0.54	2.16	0.02	0.15	97.1	35.5	39.8	19.2	23.0	36.6
<53µm>C4	17.5	1.04	3.86	0.08	0.62	94.4	32.3	34.1	39.7	45.9	17.0
<C4>C5	3.5	0.91	2.13	0.09	0.25	96.6	5.7	3.8	8.8	3.7	3.5
<C5	21.3	0.27	1.35	0.05	0.25	98.1	10.2	14.5	31.1	22.4	21.5
Total	100	0.56	1.98	0.03	0.24	97.2	100	100	100	100	100

Notes: 1) Cp-Chalcopyrite, Bn-Bornite, Ch-Chalcocite and Covellite,
Py-Pyrite, Gn-Non-Sulphide Minerals.

- 2) Mineral assays are based on gravimetric factors to convert the metal to the pure mineral.
- 3) See appendix I for details of gravimetric factors.
- 4) An assay value of "0" indicates the assay value is less than the detection limit.

TABLE 2D
ESTIMATED RELATIVE PROPORTION AND COMPOSITION OF MINERAL GRAINS
High Bornite East Zone, 154µm K80

Binary Component	Proportion by Weight-2D					Proportion by Weight-3D					Composition of Grains				
	Cp	Bn	Ch	Py	Gn	Cp	Bn	Ch	Py	Gn	Cp	Bn	Ch	Py	Gn
Liberated	0.16	0.99	0.00	0.06	95.1	0.06	0.74	0.00	0.01	94.5	100	100	100	100	100
Binary - Cp		0.24	0.00	0.03	1.2		0.30	0.00	0.04	1.4		71	48	86	84
Binary - Bn	0.10		0.03	0.00	0.6	0.12		0.03	0.00	0.8	29		41	78	49
Binary - Ch	0.00	0.03		0.00	0.0	0.00	0.04		0.00	0.0	52	59		0	93
Binary - Py	0.00	0.00	0.00		0.2	0.01	0.00	0.00		0.2	14	22	0		58
Binary - Gn	0.23	0.63	0.00	0.14		0.28	0.79	0.00	0.17		16	51	7	42	
Multiphase	0.08	0.09	0.01	0.01	0.1	0.09	0.11	0.01	0.01	0.2	23	27	2	3	45
Average Composition	0.56	1.98	0.03	0.24	97.2	0.56	1.98	0.03	0.24	97.2	21	62	7	27	99

- Notes 1) The two-dimensional proportion of minerals is a weighted estimate which is based on the liberation and the mineral content of the unsized sample.
- 2) The three-dimensional data is based on converting the two dimensional liberation data using G & T Metallurgical Services correction factors.
- 3) Composition values of "0" represents values <2% and "100" represents values >98%.

TABLE 2E
DISTRIBUTION BY SIZE RANGE OF COPPER SULPHIDES MINERALS
High Bornite East Zone, 154µm K80

Size Fraction	Mass %	% Copper Bearing Minerals						% Copper of Total Copper						% Iron of Total Iron			
		Cp	Bn	Ch	Cv	Te	En	Cp	Bn	Ch	Cv	Te	En	Cs	Py	He	Gn
>150µm	21.1	36.6	62.2	1.1	0.1	0.0	0.0	23.9	74.3	1.6	0.1	0.0	0.0	3.9	0.7	25.6	69.9
<150>53µm	36.6	20.1	79.7	0.2	0.0	0.0	0.0	12.1	87.7	0.2	0.0	0.0	0.0	9.5	1.5	34.0	55.0
<53µm>C4	17.5	21.0	78.3	0.4	0.3	0.0	0.0	12.7	86.4	0.6	0.3	0.0	0.0	12.5	4.0	33.9	49.7
<C4>C5	3.5	29.3	68.9	0.7	0.8	0.3	0.0	18.5	79.3	1.0	1.0	0.2	0.0	10.4	2.4	26.2	61.0
<C5	21.3	16.0	80.9	3.0	0.0	0.0	0.0	9.5	87.6	2.9	0.0	0.0	0.0	6.4	2.7	41.6	49.3
Total	100	23.2	75.6	1.0	0.1	0.0	0.0	14.4	84.3	1.2	0.1	0.0	0.0	9.6	2.5	34.0	54.0

- Notes 1) Cp-Chalcocopyrite, Bn-Bornite, Ch-Chalcocite, Cv-Covellite, Te-Tetrahedrite/Tennantite Group Minerals, En-Enargite. Cs-Chalcocopyrite and Bornite, Py-Pyrite, He-Hematite, Magnetite and Goethite, Gn-Non-Sulphide Minerals

TABLE 2F
COMPARATIVE ASSAY TABLE
High Bornite East Zone, 154µm K80

Methods	Cu	Fe	S
QEMSCAN	1.6	4.9	1.0
Chemical	1.5	4.9	1.0

- Notes 1) This table compares the chemical composition of the samples determined by chemical analysis with the composition determined by QEMSCAN analysis.

TABLE 2G
THE WEIGHT OF THE OBSERVED MINERALS
High Bornite East Zone, 154µm K80

Mineral	Mineral Assays (percent)					Total
	>150µm	<150>75µm	<75µm>C2	<C2>C5	<C5	
Chalcopyrite	0.32	0.65	1.06	0.98	0.30	0.59
Bornite	0.53	2.56	3.96	2.30	1.51	2.15
Chalcocite	0.01	0.00	0.02	0.02	0.06	0.02
Covellite	0.00	0.00	0.01	0.03	0.00	0.00
Tetrahedrite	0.00	0.00	0.00	0.01	0.00	0.00
Enargite	0.00	0.00	0.00	0.00	0.00	0.00
Molybdenite	0.01	0.00	0.09	0.03	0.00	0.02
Pyrite	0.06	0.17	0.52	0.27	0.24	0.23
Iron Oxides	1.95	3.27	3.93	2.60	3.26	3.08
Quartz	40.8	43.4	34.7	30.5	39.2	40.0
Micas	22.3	19.3	21.1	25.4	23.5	21.4
Ankerite	18.0	17.9	19.7	21.3	7.08	16.0
Feldspars	10.2	7.83	8.33	10.4	5.4	8.0
Ti Mineral Group	0.52	0.42	0.63	0.63	2.13	0.85
Apatite	0.30	0.68	0.81	0.71	1.66	0.83
Amphibole	1.24	0.87	0.75	0.65	0.70	0.89
Calcite	0.30	0.18	0.47	0.66	1.01	0.45
Dolomite	0.42	0.43	0.63	0.78	2.28	0.87
Garnet	0.50	0.37	0.34	0.28	4.01	1.16
Kaolinite (clay)	0.39	0.49	0.35	0.15	2.49	0.86
Barite	0.31	0.16	0.34	0.45	0.00	0.20
Pyroxene	0.12	0.11	0.08	0.08	1.07	0.31
Chlorite	0.03	0.01	0.02	0.08	0.77	0.18
Epidote	0.04	0.03	0.03	0.02	0.67	0.17
Alunite	0.01	0.01	0.01	0.01	1.11	0.24
Tourmaline	0.02	0.03	0.02	0.01	0.19	0.06
Others	1.65	1.19	2.10	1.50	1.40	1.50
Total	100	100	100	100	100	100

- Note: 1) Tennantite includes Tennantite/Tetrahedrite Group Minerals.
2) Iron Oxides includes Hematite, Magnetite, Hematite and Goethite.
3) Feldspar includes K-Feldspar, Feldspar-Albite and Alkali-Feldspar.
4) Micas-Muscovite, Biotite and Plogopite.
5) Ti-Minerals: Rutile/Anatase, Ilmenite and Sphene.
6) Garnet-Andradite, Grossular and Almandine.
7) Others includes trace amount of Sphalerite and unresolved mineral species.

APPENDIX VI – KM2543

ADIS ANALYSIS DATA

INDEX

<u>TABLE</u>		<u>PAGE</u>
1	KM2543 Test 1 Copper Rougher Concentrate	1
2	KM2543 Test 1 Pyrite Rougher Concentrate	5
3	KM2543 Test 2 Copper Rougher Concentrate	9
4	KM2543 Test 2 Pyrite Rougher Concentrate	13
5	KM2543 Test 15 Pan Concentrate	17
6	KM2543 Test 15 Knelson Tailings	18
7	KM2543 Test 16 Pan Concentrate	21

PHOTOMICROGRAPHS

1	KM2543 Test 1 Copper Rougher Concentrate	5
2	KM2543 Test 1 Pyrite Rougher Concentrate	8
3	KM2543 Test 2 Copper Rougher Concentrate	12
4	KM2543 Test 2 Pyrite Rougher Concentrate	16
5	KM2543 Test 15 Knelson Tailings	20
6	KM2543 Test 16 Pan Concentrate	24

TABLE 1A
AVERAGE SIZE OF THE GOLD OCCURRENCES BY CLASS OF ASSOCIATION
KM2543 Test 1 Copper Rougher Concentrate

Particles Observed	Mode of Occurrence	Average Projected Area Diameter - microns					Area % Gold
		Au	Cp	Py	Ma	Gn	
5	Gold-Chalcopyrite Adhesion Binary	10	17	-	-	-	20

Notes: a) Au-Gold, Cp-Chalcopyrite, Py-Pyrite, Ma-Magnetite, Gn-Gangue
b) Projected area diameter is the diameter of a circle in mineralogical terms.

TABLE 1B
AVERAGE COMPOSITION BY MASS OF THE GOLD OCCURRENCES BY CLASS OF ASSOCIATION
KM2543 Test 1 Copper Rougher Concentrate

Particles Observed	Mode of Occurrence	Average Mass - Percent				
		Au	Cp	Py	Ma	Gn
5	Gold-Chalcopyrite Adhesion Binary	37	63	-	-	-

Notes: a) Au-Gold, Cp-Chalcopyrite, Py-Pyrite, Ma-Magnetite, Gn-Gangue
b) Mass data assumes particles are spherical in shape.

TABLE 1C
DISTRIBUTION OF GOLD OCCURRENCES BY CLASS OF ASSOCIATION
KM2543 Test 1 Copper Rougher Concentrate

Sample	Liberated	Locked in Binary With:				MP
		Cp	Py	Ma	Gn	
Test-01 Copper Concentrate	-	100	-	-	-	-

Notes: a) Cp-Chalcopyrite, Py-Pyrite, Ma-Magnetite, Gn-Gangue

TABLE 1D
DISTRIBUTION OF GOLD MASS BY CLASS OF ASSOCIATION
KM2543 Test 1 Copper Rougher Concentrate

Sample	Liberated	Locked in Binary With:				MP
		Cp	Py	Ma	Gn	
Test-01 Copper Concentrate	-	100	-	-	-	-

Notes: a) Cp-Chalcopyrite, Py-Pyrite, Ma-Magnetite, Gn-Gangue

TABLE 1E
SUMMARY OF ADIS ANALYSIS OF GOLD
KM2543 Test 1 Copper Rougher Concentrate

Parameter	Units
Size Fraction	Unsize
Number of Slides Scanned	5
Number of Particles Scanned	2.1×10^6
Total Surface Area of Particles	$8.8 \times 10^8 \mu\text{m}^2$
Total Surface Area of Gold	$545 \mu\text{m}^2$
Estimated Volume of All Particles	$45.9 \times 10^9 \mu\text{m}^3$
Estimated Volume of Gold Grains	$6444 \mu\text{m}^3$
Number of Gold Occurrences	5
Mean Projected Diameter of Gold	$9.8 \mu\text{m}$
Measured Gold Content	26.5 g/t

TABLE 1F
STATUS OF GOLD OCCURRENCES BY CLASS OF ASSOCIATION
KM2543 Test 1 Copper Rougher Concentrate

Particle	Mode of Occurrence	Projected Area Diameter - microns					Area % Gold
		Au	Cp	Py	Ma	Gn	
1	Gold-Chalcopryrite Adhesion Binary	11	34	-	-	-	9
2	Gold-Chalcopryrite Adhesion Binary	4	2	-	-	-	72
3	Gold-Chalcopryrite Adhesion Binary	4	2	-	-	-	73
4	Gold-Chalcopryrite Adhesion Binary	22	38	-	-	-	25
5	Gold-Chalcopryrite Adhesion Binary	9	9	-	-	-	47

Notes: a) Au-Gold, Cp-Chalcopryrite, Py-Pyrite, Ma-Magnetite, Gn-Gangue
b) Projected area diameter is the diameter of a circle in mineralogical terms.

TABLE 1G
STATUS OF GOLD OCCURRENCES BY MASS BY CLASS OF ASSOCIATION
KM2543 Test 1 Copper Rougher Concentrate

Particle	Mode of Occurrence	Mass - Percent				
		Au	Cp	Py	Ma	Gn
1	Gold-Chalcopryrite Adhesion Binary	12	88	-	-	-
2	Gold-Chalcopryrite Adhesion Binary	95	5	-	-	-
3	Gold-Chalcopryrite Adhesion Binary	95	5	-	-	-
4	Gold-Chalcopryrite Adhesion Binary	46	54	-	-	-
5	Gold-Chalcopryrite Adhesion Binary	80	20	-	-	-

Notes: a) Au-Gold, Cp-Chalcopryrite, Py-Pyrite, Ma-Magnetite, Gn-Gangue
b) Mass data assumes particles are spherical in shape.

PHOTOMICROGRAPH 1
RED CHRIS – COPPER ROUGHER CONCENTRATE
KM2543 Test 1

Particle 1

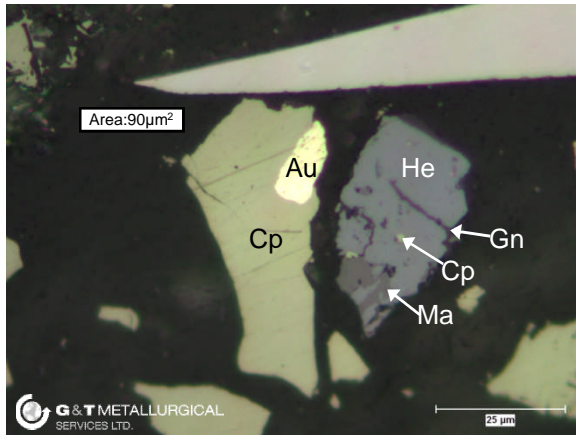

Particle 2

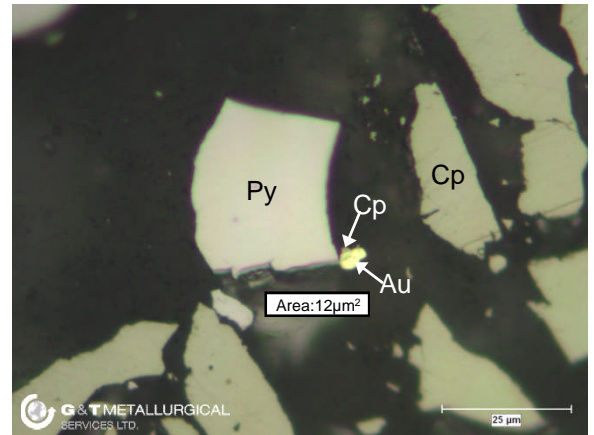

Particle 3

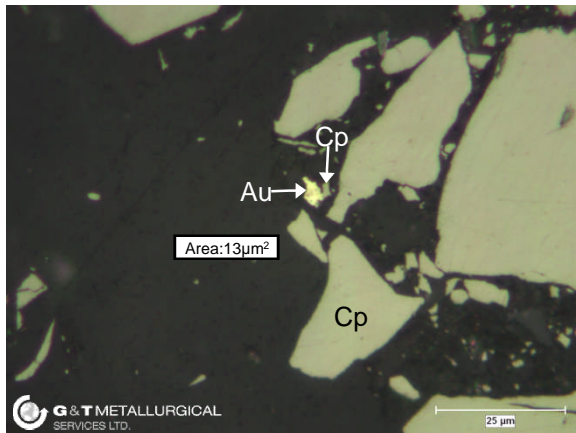

Particle 4

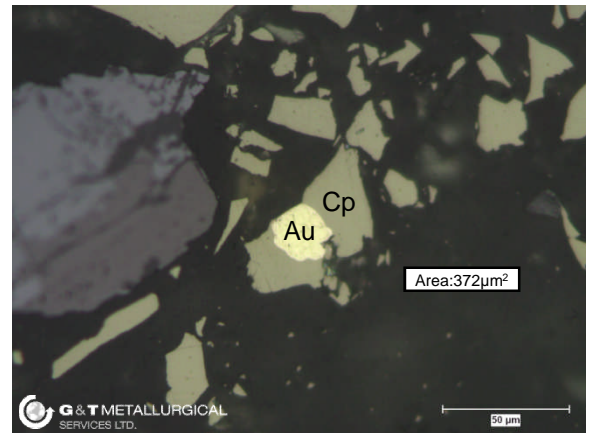

Particle 5

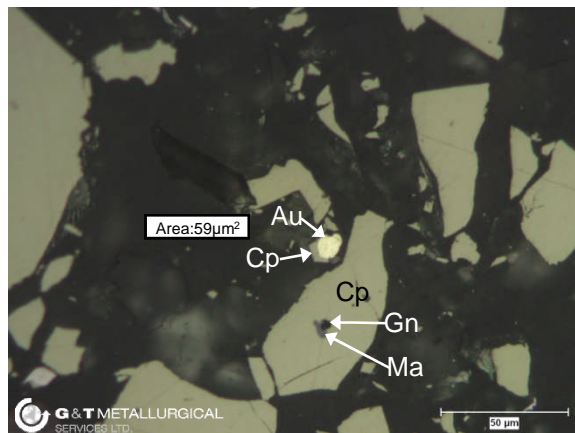

*Au-Gold, Cp-Chalcopyrite, Py-Pyrite, Ma-Magnetite, He-Hematite, Gn-Gangue.

TABLE 2A
AVERAGE SIZE OF THE GOLD OCCURRENCES BY CLASS OF ASSOCIATION
KM2543 Test 1 Pyrite Rougher Concentrate

Particles Observed	Mode of Occurrence	Average Projected Area Diameter - microns					Area % Gold
		Au	Cp	Py	Ma	Gn	
3	Gold Inclusion Multiphase	11	122	3	12	89	<1
1	Gold Adhesion Multiphase	16	36	-	-	255	<1

Notes: a) Au-Gold, Cp-Chalcopyrite, Py-Pyrite, Ma-Magnetite, Gn-Gangue
b) Projected area diameter is the diameter of a circle in mineralogical terms.

TABLE 2B
AVERAGE COMPOSITION BY MASS OF THE GOLD OCCURRENCES BY CLASS OF ASSOCIATION
KM2543 Test 1 Pyrite Rougher Concentrate

Particles Observed	Mode of Occurrence	Average Mass - Percent				
		Au	Cp	Py	Ma	Gn
3	Gold Inclusion Multiphase	<1	75	<1	<1	25
1	Gold Adhesion Multiphase	<1	<1	-	-	100

Notes: a) Au-Gold, Cp-Chalcopyrite, Py-Pyrite, Ma-Magnetite, Gn-Gangue
b) Mass data assumes particles are spherical in shape.

TABLE 2C
DISTRIBUTION OF GOLD OCCURRENCES BY CLASS OF ASSOCIATION
KM2543 Test 1 Pyrite Rougher Concentrate

Sample	Liberated	Locked in Binary With:			MP
		Cp	Py	Gn	
Pyrite Rougher Concentrate	-	-	-	-	100

Notes: a) Cp-Chalcopyrite, Py-Pyrite, Gn-Gangue, MP-Multiphase.

TABLE 2D
DISTRIBUTION OF GOLD MASS BY CLASS OF ASSOCIATION
KM2543 Test 1 Pyrite Rougher Concentrate

Sample	Liberated	Locked in Binary With:			MP
		Cp	Py	Gn	
Pyrite Rougher Concentrate	-	-	-	-	100

Notes: a) Cp-Chalcopyrite, Py-Pyrite, Gn-Gangue, MP-Multiphase.
b) Mass data assumes particles are spherical in shape.

TABLE 2E
SUMMARY OF ADIS ANALYSIS OF GOLD
KM2543 Test 1 Pyrite Rougher Concentrate

Parameter	Units
Size Fraction	Unsize
Number of Slides Scanned	10
Number of Particles Scanned	4.5×10^5
Total Surface Area of Particles	$1.4 \times 10^9 \mu\text{m}^2$
Total Surface Area of Gold	$487.0 \mu\text{m}^2$
Estimated Volume of All Particles	$1.3 \times 10^{11} \mu\text{m}^3$
Estimated Volume of Gold Grains	$4475 \mu\text{m}^3$
Number of Gold Occurrences	4
Mean Projected Diameter of Gold	$11.9 \mu\text{m}$
Measured Gold Content	3.2 g/t

TABLE 2F
STATUS OF GOLD OCCURRENCES BY CLASS OF ASSOCIATION
KM2543 Test 1 Pyrite Rougher Concentrate

Particle	Mode of Occurrence	Projected Area Diameter - microns					Area % Gold
		Au	Cp	Py	Ma	Gn	
1	Gold Inclusion Multiphase	14	-	8	26	184	<1
2	Gold Inclusion Multiphase	11	212	-	9	-	<1
3	Gold Inclusion Multiphase	7	153	-	-	84	<1
4	Gold Adhesion Multiphase	16	36	-	-	255	<1

Notes: a) Au-Gold, Cp-Chalcopyrite, Py-Pyrite, Ma-Magnetite, Gn-Gangue
b) Projected area diameter is the diameter of a circle in mineralogical terms.

TABLE 2G
STATUS OF GOLD OCCURRENCES BY MASS BY CLASS OF ASSOCIATION
KM2543 Test 1 Pyrite Rougher Concentrate

Particle	Mode of Occurrence	Mass - Percent				
		Au	Cp	Py	Ma	Gn
1	Gold Inclusion Multiphase	<1	-	<1	<1	100
2	Gold Inclusion Multiphase	<1	100	-	<1	-
3	Gold Inclusion Multiphase	<1	90	-	-	10
4	Gold Adhesion Multiphase	<1	<1	-	-	100

Notes: a) Au-Gold, Cp-Chalcopyrite, Py-Pyrite, Ma-Magnetite, Gn-Gangue
b) Mass data assumes particles are spherical in shape.

PHOTOMICROGRAPH 2
RED CHRIS – PYRITE ROUGHER CONCENTRATE
KM2543 Test 1

Particle 1

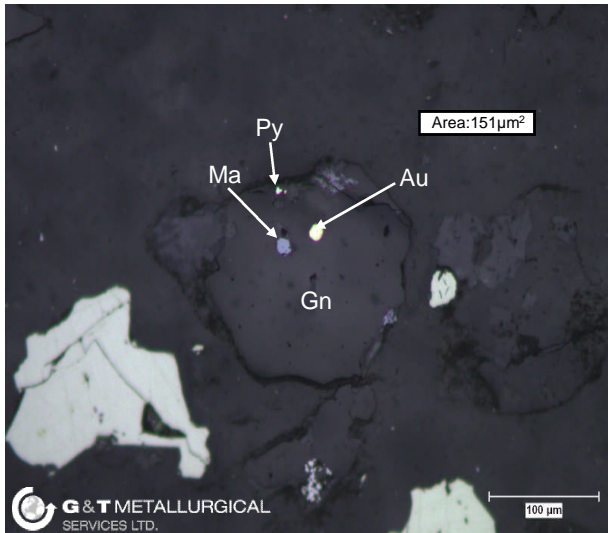

Particle 2

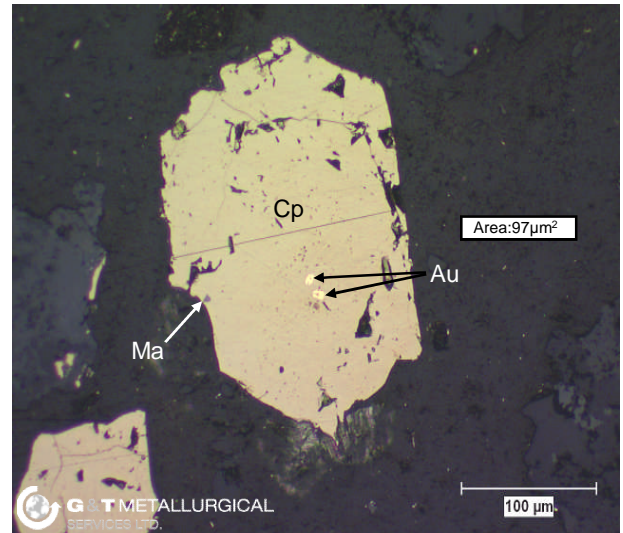

Particle 3

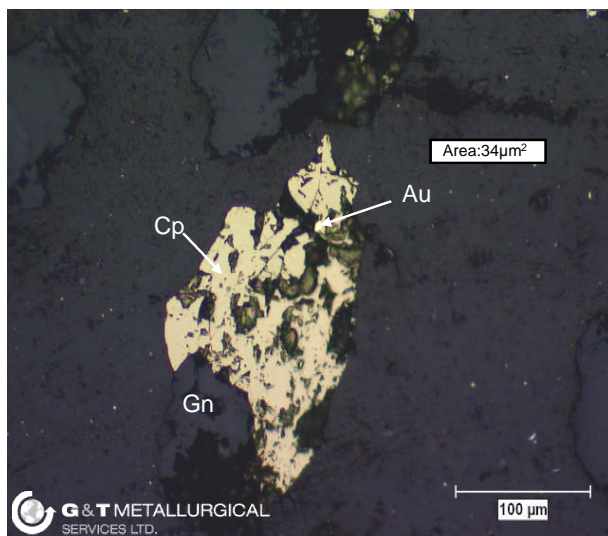

Particle 4

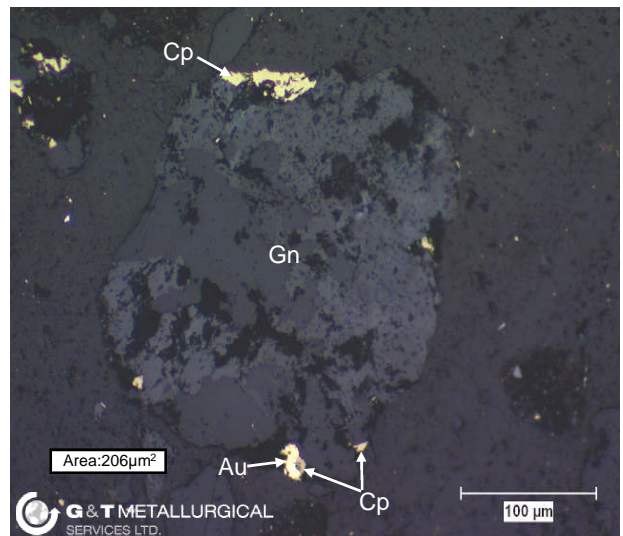

* Au-Gold, Cp-Chalcopyrite, Py-Pyrite, Ma-Magnetite, Gn-Gangue.

TABLE 3A
AVERAGE SIZE OF THE GOLD OCCURRENCES BY CLASS OF ASSOCIATION
KM2543 Test 2 Copper Rougher Concentrate

Particles Observed	Mode of Occurrence	Average Projected Area Diameter - microns					Area % Gold
		Au	Cp	Bn	Ma	Gn	
3	Liberated Gold	6	-	-	-	-	100
5	Gold-Copper Sulphide Adhesion Binary	7	11	26	-	-	4
2	Gold-Copper Sulphide Inclusion Binary	4	2	67	-	-	<1
1	Gold-Gangue Adhesion Binary	6	-	-	-	7	41
1	Gold Inclusion Multiphase	6	-	34	4	75	<1

Notes: a) Au-Gold, Cp-Chalcopyrite, Bn-Bornite, Ma-Magnetite, Gn-Gangue
b) Projected area diameter is the diameter of a circle in mineralogical terms.

TABLE 3B
AVERAGE COMPOSITION BY MASS OF THE GOLD OCCURRENCES BY CLASS OF ASSOCIATION
KM2543 Test 2 Copper Rougher Concentrate

Particles Observed	Mode of Occurrence	Average Mass - Percent				
		Au	Cp	Bn	Ma	Gn
3	Liberated Gold	100	-	-	-	-
5	Gold-Copper Sulphide Adhesion Binary	3	35	62	-	-
2	Gold-Copper Sulphide Inclusion Binary	<1	<1	100	-	-
1	Gold-Gangue Adhesion Binary	81	-	-	-	19
1	Gold Inclusion Multiphase	<1	-	16	<1	84

Notes: a) Au-Gold, Cp-Chalcopyrite, Bn-Bornite, Ma-Magnetite, Gn-Gangue
b) Mass data assumes particles are spherical in shape.

TABLE 3C
DISTRIBUTION OF GOLD OCCURRENCES BY CLASS OF ASSOCIATION
KM2543 Test 2 Copper Rougher Concentrate

Sample	Liberated	Locked in Binary With:			MP
		Cs	Ma	Gn	
Copper Rougher Concentrate	25	58	-	8	8

Notes: a) Cs-Copper Sulphides including Chalcopyrite and Bornite, Ma-Magnetite, Gn-Gangue

TABLE 3D
DISTRIBUTION OF GOLD MASS BY CLASS OF ASSOCIATION
KM2543 Test 2 Copper Rougher Concentrate

Sample	Liberated	Locked in Binary With:			MP
		Cs	Ma	Gn	
Copper Rougher Concentrate	24	66	-	6	5

Notes: a) Cs-Copper Sulphides including Calcopyrite and Bornite, Ma-Magnetite, Gn-Gangue

b) Mass data assumes particles are spherical in shape.

TABLE 3E
SUMMARY OF ADIS ANALYSIS OF GOLD
KM2543 Test 2 Copper Rougher Concentrate

Parameter	Units
Size Fraction	Unsize
Number of Slides Scanned	5
Number of Particles Scanned	1.8×10^6
Total Surface Area of Particles	$7.3 \times 10^8 \mu\text{m}^2$
Total Surface Area of Gold	$419.8 \mu\text{m}^2$
Estimated Volume of All Particles	$5.1 \times 10^{10} \mu\text{m}^3$
Estimated Volume of Gold Grains	$2180.3 \mu\text{m}^3$
Number of Gold Occurrences	12
Mean Projected Diameter of Gold	$6.3 \mu\text{m}$
Measured Gold Content	30.1 g/t

TABLE 3F
STATUS OF GOLD OCCURRENCES BY CLASS OF ASSOCIATION
KM2543 Test 2 Copper Rougher Concentrate

Particle	Mode of Occurrence	Projected Area Diameter - microns					Area % Gold
		Au	Cp	Bn	Ma	Gn	
1	Gold-Gangue Adhesion Binary	6	-	-	-	7	41
2	Gold-Bornite Adhesion Binary	11	-	15	-	-	33
3	Gold-Bornite Inclusion Binary	4	-	55	-	-	<1
4	Liberated	9	-	-	-	-	100
5	Liberated	4	-	-	-	-	100
6	Gold-Bornite Adhesion Binary	7	-	19	-	-	11
7	Gold-Copper Sulphide Adhesion Binary	4	53	21	-	-	<1
8	Gold-Copper Sulphide Inclusion Binary	4	5	80	-	-	<1
9	Gold-Bornite Adhesion Binary	9	-	43	-	-	4
10	Gold Inclusion Multiphase	6	-	34	4	75	<1
11	Gold-Bornite Adhesion Binary	6	-	31	-	-	4
12	Liberated	6	-	-	-	-	100

Notes: a) Au-Gold, Cp-Chalcopyrite, Bn-Bornite, Ma-Magnetite, Gn-Gangue
b) Projected area diameter is the diameter of a circle in mineralogical terms.

TABLE 3G
STATUS OF GOLD OCCURRENCES BY MASS BY CLASS OF ASSOCIATION
KM2543 Test 2 Copper Rougher Concentrate

Particle	Mode of Occurrence	Mass - Percent				
		Au	Cp	Bn	Ma	Gn
1	Gold-Gangue Adhesion Binary	81	-	-	-	19
2	Gold-Bornite Adhesion Binary	56	-	44	-	-
3	Gold-Bornite Inclusion Binary	<1	-	100	-	-
4	Liberated	100	-	-	-	-
5	Liberated	100	-	-	-	-
6	Gold-Bornite Adhesion Binary	14	-	86	-	-
7	Gold-Copper Sulphide Adhesion Binary	<1	93	7	-	-
8	Gold-Copper Sulphide Inclusion Binary	<1	<1	100	-	-
9	Gold-Bornite Adhesion Binary	3	-	97	-	-
10	Gold Inclusion Multiphase	<1	-	16	<1	84
11	Gold-Bornite Adhesion Binary	<1	-	100	-	-
12	Liberated	100	-	-	-	-

Notes: a) Au-Gold, Cp-Chalcopyrite, Bn-Bornite, Ma-Magnetite, Gn-Gangue
b) Mass data assumes particles are spherical in shape.

PHOTOMICROGRAPH 3
RED CHRIS – COPPER ROUGHER CONCENTRATE
KM2543 Test 2

Particle 4

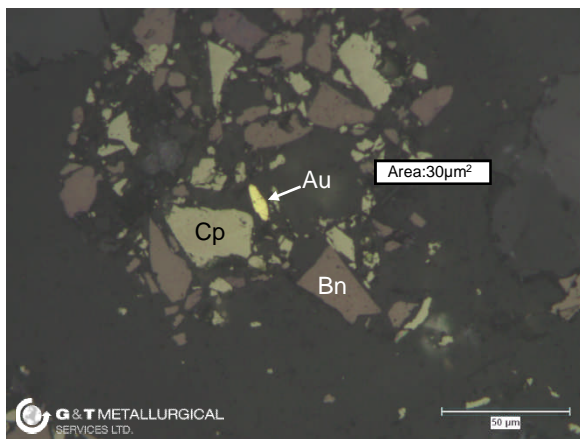

Particle 6

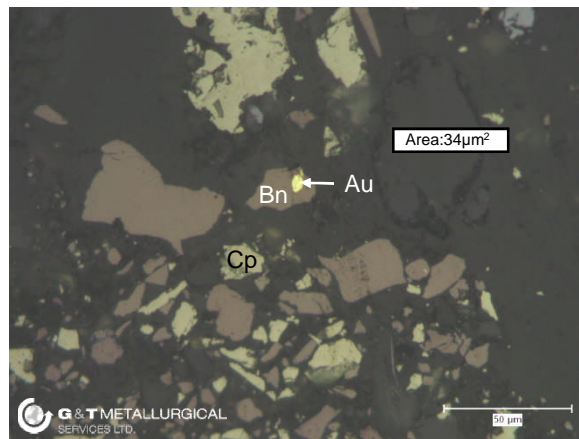

Particle 7

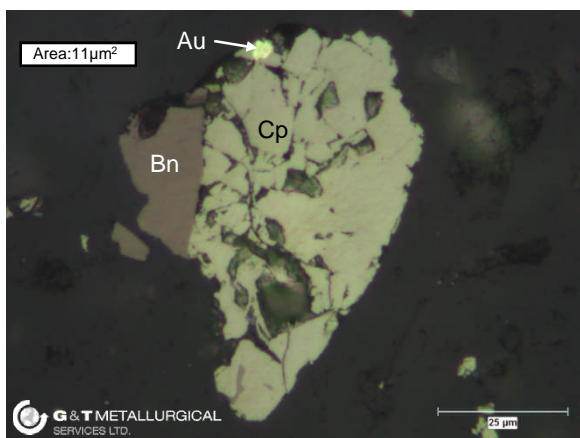

Particle 8

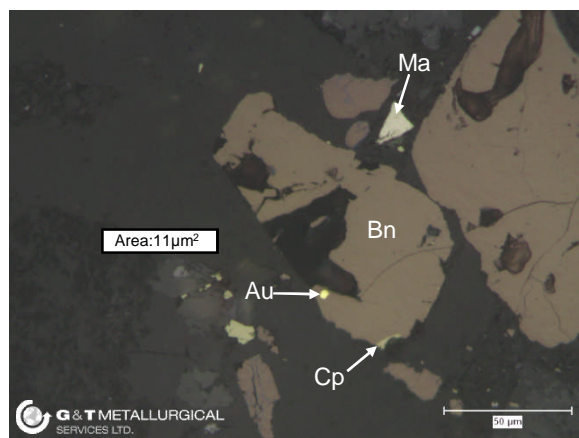

Particle 9

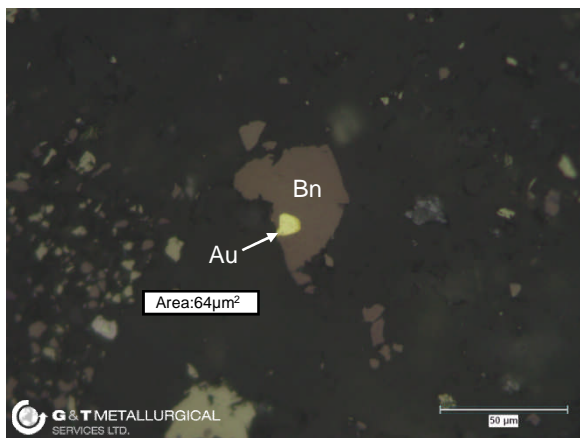

Particle 11

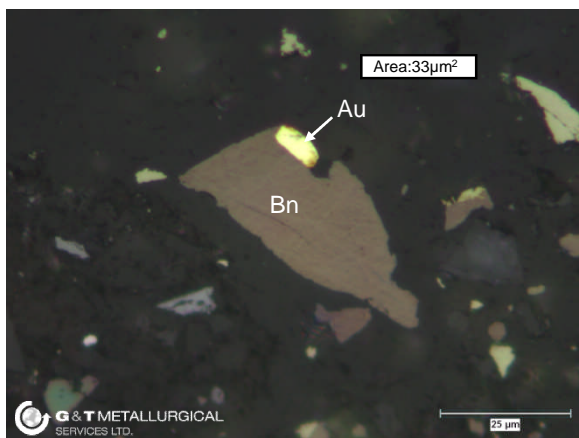

*Au-Gold, Cp-Chalcopyrite, Bn-Bornite, Ma-Magnetite.

TABLE 4A
AVERAGE SIZE OF THE GOLD OCCURRENCES BY CLASS OF ASSOCIATION
KM2543 Test 2 Pyrite Rougher Concentrate

Particles Observed	Mode of Occurrence	Average Projected Area Diameter - microns					Area % Gold
		Au	Cp	Bn	He	Gn	
1	Liberated Gold	2	-	-	-	-	100
1	Gold-Gangue Inclusion Binary	5	-	-	-	35	2
1	Gold Adhesion Multiphase	7	-	28	-	66	1
8	Gold Inclusion Multiphase	5	6	20	2	69	<1

Notes: a) Au-Gold, Cp-Chalcopyrite, Bn-Bornite, He-Hematite, Gn-Gangue
b) Projected area diameter is the diameter of a circle in mineralogical terms.

TABLE 4B
AVERAGE COMPOSITION BY MASS OF THE GOLD OCCURRENCES BY CLASS OF ASSOCIATION
KM2543 Test 2 Pyrite Rougher Concentrate

Particles Observed	Mode of Occurrence	Average Mass - Percent				
		Au	Cp	Bn	He	Gn
1	Liberated Gold	100	-	-	-	-
1	Gold-Gangue Inclusion Binary	3	-	-	-	97
1	Gold Adhesion Multiphase	<1	-	13	-	87
8	Gold Inclusion Multiphase	<1	<1	3	<1	97

Notes: a) Au-Gold, Cp-Chalcopyrite, Bn-Bornite, He-Hematite, Gn-Gangue.
b) Mass data assumes particles are spherical in shape.

TABLE 4C
DISTRIBUTION OF GOLD OCCURRENCES BY CLASS OF ASSOCIATION
KM2543 Test 2 Pyrite Rougher Concentrate

Sample	Liberated	Locked in Binary With:				MP
		Cp	Bn	He	Gn	
Test 02 Pyrite Rougher Concentrate	9	-	-	-	9	82

Notes: a) Cp-Chalcopyrite, Bn-Bornite, He-Hematite, Gn-Gangue.

TABLE 4D
DISTRIBUTION OF GOLD MASS BY CLASS OF ASSOCIATION
KM2543 Test 2 Pyrite Rougher Concentrate

Sample	Liberated	Locked in Binary With:				MP
		Cp	Bn	He	Gn	
Test 02 Pyrite Rougher Concentrate	<1	-	-	-	4	96

Notes: a) Cp-Chalcopyrite, Bn-Bornite, He-Hematite, Gn-Gangue.
b) Mass data assumes particles are spherical in shape.

TABLE 4E
SUMMARY OF ADIS ANALYSIS OF GOLD
KM2543 Test 2 Pyrite Rougher Concentrate

Parameter	Units
Size Fraction	Unsize
Number of Slides Scanned	15
Number of Particles Scanned	3.5×10^6
Total Surface Area of Particles	$2.6 \times 10^9 \mu\text{m}^2$
Total Surface Area of Gold	$354.6 \mu\text{m}^2$
Estimated Volume of All Particles	$2.0 \times 10^{11} \mu\text{m}^3$
Estimated Volume of Gold Grains	$2369.6 \mu\text{m}^3$
Number of Gold Occurrences	11
Mean Projected Diameter of Gold	$5.4 \mu\text{m}$
Measured Gold Content	2.5 g/t

TABLE 4F
STATUS OF GOLD OCCURRENCES BY CLASS OF ASSOCIATION
KM2543 Test 2 Pyrite Rougher Concentrate

Particle	Mode of Occurrence	Projected Area Diameter - microns					Area % Gold
		Au	Cp	Bn	He	Gn	
1	Gold Inclusion Multiphase	14	5	40	-	83	2
2	Liberated Gold	2	-	-	-	-	100
3	Gold Inclusion Multiphase	3	13	10	-	109	0
4	Gold Inclusion Multiphase	2	-	15	-	91	0
5	Gold Inclusion Multiphase	4	17	11	-	161	0
6	Gold Inclusion Multiphase	8	3	24	15	56	2
7	Gold Inclusion Multiphase	6	-	19	3	24	4
8	Gold Inclusion Multiphase	3	3	17	-	19	2
9	Gold Inclusion Multiphase	2	5	20	-	8	1
10	Gold Adhesion Multiphase	7	-	28	-	66	1
11	Gold-Gangue Inclusion Binary	5	-	-	-	35	2

Notes: a) Au-Gold, Cp-Chalcopyrite, Bn-Bornite, He-Hematite, Gn-Gangue

b) Projected area diameter is the diameter of a circle in mineralogical terms.

TABLE 4G
STATUS OF GOLD OCCURRENCES BY MASS BY CLASS OF ASSOCIATION
KM2543 Test 2 Pyrite Rougher Concentrate

Particle	Mode of Occurrence	Mass - Percent				
		Au	Cp	Bn	He	Gn
1	Gold Inclusion Multiphase	3	<1	17	-	80
2	Liberated Gold	100	-	-	-	-
3	Gold Inclusion Multiphase	<1	<1	<1	-	100
4	Gold Inclusion Multiphase	<1	-	<1	-	100
5	Gold Inclusion Multiphase	<1	<1	<1	-	100
6	Gold Inclusion Multiphase	2	<1	13	4	82
7	Gold Inclusion Multiphase	6	-	46	<1	48
8	Gold Inclusion Multiphase	1	<1	59	-	39
9	Gold Inclusion Multiphase	<1	1	96	-	3
10	Gold Adhesion Multiphase	<1	-	13	-	87
11	Gold-Gangue Inclusion Binary	3	-	-	-	97

Notes: a) Au-Gold, Cp-Chalcopyrite, Bn-Bornite, He-Hematite, Gn-Gangue

b) Mass data assumes particles are spherical in shape.

PHOTOMICROGRAPH 4
RED CHRIS – PYRITE ROUGHER CONCENTRATE
KM2543 Test 2

Particle 1

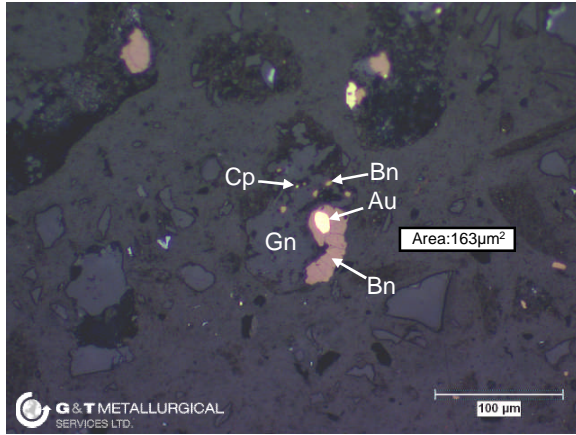

Particle 5

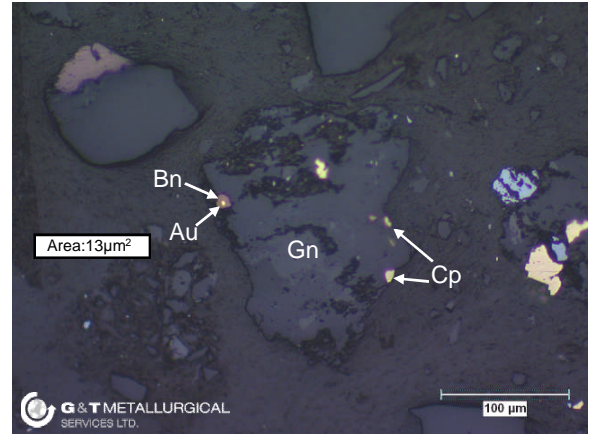

Particle 6

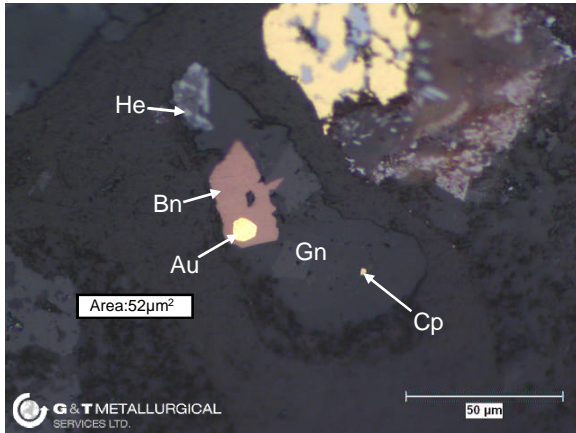

Particle 7

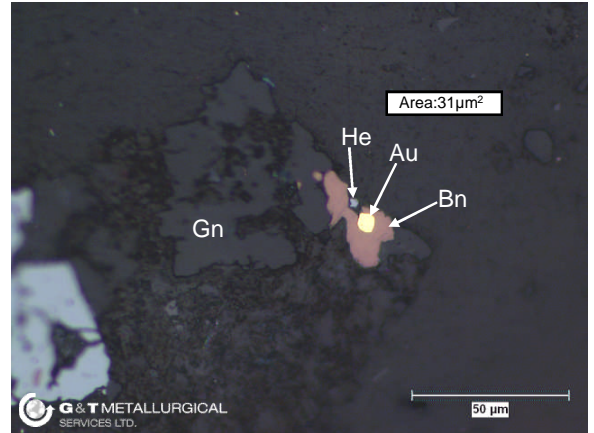

Particle 9

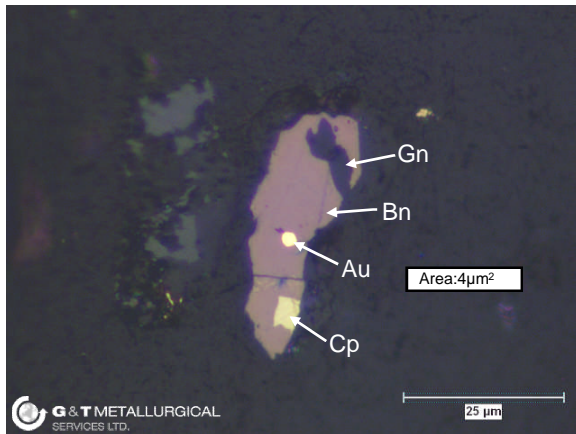

Particle 10

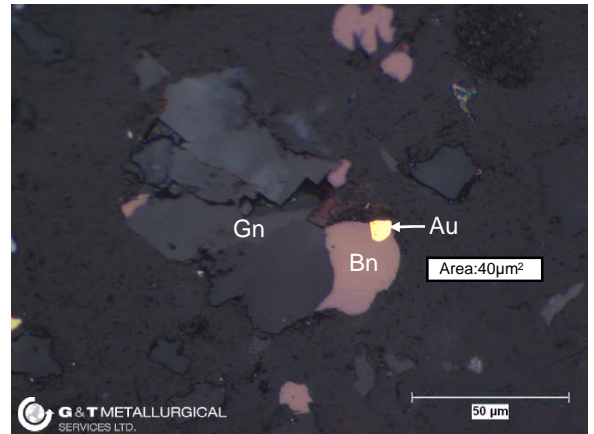

*Au-Gold, Cp-Chalcopyrite, Bn-Bornite, He-Hematite, Gn-Gangue.

TABLE 5A
SUMMARY OF ADIS ANALYSIS OF GOLD
KM2543 Test 15 Pan Concentrate

Parameter	Units
Size Fraction	Unsize
Number of Slides Scanned	20
Number of Particles Scanned	3.6×10^5
Total Surface Area of Particles	$3.1 \times 10^9 \mu\text{m}^2$
Total Surface Area of Gold	$0.0 \mu\text{m}^2$
Estimated Volume of All Particles	$2.8 \times 10^{11} \mu\text{m}^3$
Estimated Volume of Gold Grains	$0 \mu\text{m}^3$
Number of Gold Occurrences	0
Mean Projected Diameter of Gold	$0 \mu\text{m}$
Measured Gold Content	2.12 g/t

TABLE 6A
AVERAGE SIZE OF THE GOLD OCCURRENCES BY CLASS OF ASSOCIATION
KM2543 Test 15 Knelson Tailings

Particles Observed	Mode of Occurrence	Average Projected Area Diameter - microns					Area % Gold
		Au	Cp	Py	Ma	Gn	
1	Gold-Gangue Inclusion Binary	8	-	-	-	31	7

Notes: a) Au-Gold, Cp-Chalcopyrite, Py-Pyrite, Ma-Magnetite, Gn-Gangue
b) Projected area diameter is the diameter of a circle in mineralogical terms.

TABLE 6B
AVERAGE COMPOSITION BY MASS OF THE GOLD OCCURRENCES BY CLASS OF ASSOCIATION
KM2543 Test 15 Knelson Tailings

Particles Observed	Mode of Occurrence	Average Mass - Percent				
		Au	Cp	Py	Ma	Gn
1	Gold-Gangue Inclusion Binary	13	-	-	-	87

Notes: a) Au-Gold, Cp-Chalcopyrite, Py-Pyrite, Ma-Magnetite, Gn-Gangue
b) Mass data assumes particles are spherical in shape.

TABLE 6C
DISTRIBUTION OF GOLD OCCURRENCES BY CLASS OF ASSOCIATION
KM2543 Test 15 Knelson Tailings

Sample	Liberated	Locked in Binary With:				MP
		Cp	Py	Ma	Gn	
Knelson Tailings	-	-	-	-	100	-

Notes: a) Au-Gold, Cp-Chalcopyrite, Py-Pyrite, Ma-Magnetite, Gn-Gangue

TABLE 6D
DISTRIBUTION OF GOLD MASS BY CLASS OF ASSOCIATION
KM2543 Test 15 Knelson Tailings

Sample	Liberated	Locked in Binary With:				MP
		Cp	Py	Ma	Gn	
Knelson Tailings	-	-	-	-	100	-

Notes: a) Au-Gold, Cp-Chalcopyrite, Py-Pyrite, Ma-Magnetite, Gn-Gangue
b) Mass data assumes particles are spherical in shape.

TABLE 6E
SUMMARY OF ADIS ANALYSIS OF GOLD
KM2543 Test 15 Knelson Tailings

Parameter	Units
Size Fraction	Unsize
Number of Slides Scanned	55
Number of Particles Scanned	8.1 x 10 ⁶
Total Surface Area of Particles	1.7 x 10 ⁸ μm ²
Total Surface Area of Gold	56.1 μm ²
Estimated Volume of All Particles	3.3 x 10 ¹¹ μm ³
Estimated Volume of Gold Grains	316.3 μm ³
Number of Gold Occurrences	1
Mean Projected Diameter of Gold	8.45 μm
Measured Gold Content	0.48 g/t

TABLE 6F
STATUS OF GOLD OCCURRENCES BY CLASS OF ASSOCIATION
KM2543 Test 15 Knelson Tailings

Particle	Mode of Occurrence	Projected Area Diameter - microns					Area % Gold
		Au	Cp	Py	Ma	Gn	
1	Gold-Gangue Inclusion Binary	8	-	-	-	31	7

Notes: a) Au-Gold, Cp-Chalcopryrite, Py-Pyrite, Ma-Magnetite, Gn-Gangue
b) Projected area diameter is the diameter of a circle in mineralogical terms.

TABLE 6G
STATUS OF GOLD OCCURRENCES BY MASS BY CLASS OF ASSOCIATION
KM2543 Test 15 Knelson Tailings

Particle	Mode of Occurrence	Mass - Percent				
		Au	Cp	Py	Ma	Gn
1	Gold-Gangue Inclusion Binary	13	-	-	-	87

Notes: a) Au-Gold, Cp-Chalcopryrite, Py-Pyrite, Ma-Magnetite, Gn-Gangue
b) Mass data assumes particles are spherical in shape.

PHOTOMICROGRAPH 5
RED CHRIS – KNELSON TAILINGS
KM2543 Test 15

Particle 1

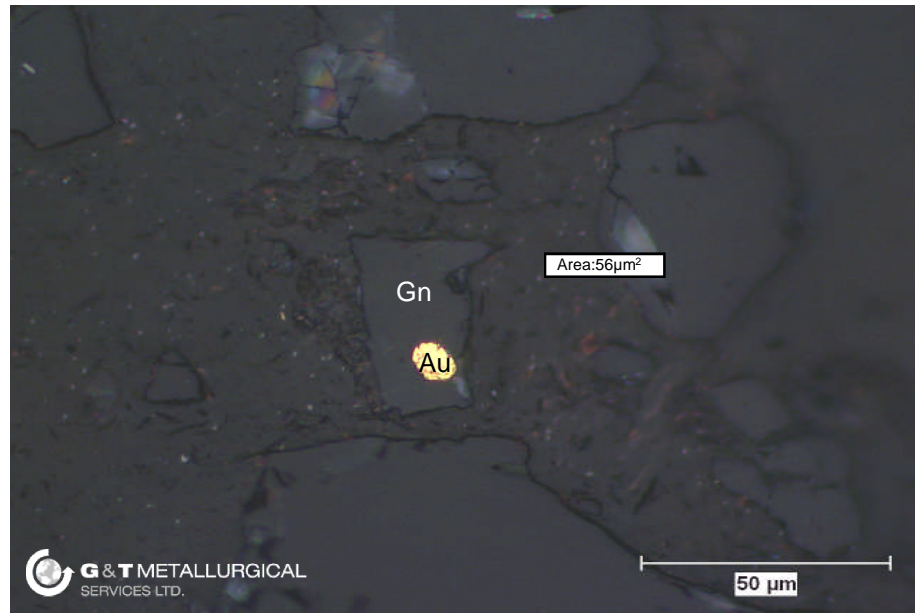

*Au-Gold, Gn-Gangue

TABLE 7A
AVERAGE SIZE OF THE GOLD OCCURRENCES BY CLASS OF ASSOCIATION
KM2543 Test 16 Pan Concentrate

Particles Observed	Mode of Occurrence	Average Projected Area Diameter - microns				Area % Gold
		Au	Bn	He	Gn	
1	Gold-Gangue Binary	5	-	39	123	<1
1	Gold Adhesion Multiphase	6	3	-	41	2
1	Gold Inclusion Multiphase	6	20	-	158	<1

Notes: a) Au-Gold, Bn-Bornite, He-Hematite, Gn-Gangue
b) Projected area diameter is the diameter of a circle in mineralogical terms.

TABLE 7B
AVERAGE COMPOSITION BY MASS OF THE GOLD OCCURRENCES BY CLASS OF ASSOCIATION
KM2543 Test 16 Pan Concentrate

Particles Observed	Mode of Occurrence	Average Mass - Percent			
		Au	Bn	He	Gn
1	Gold-Gangue Binary	<1	-	6	94
1	Gold Adhesion Multiphase	2	<1	-	98
1	Gold Inclusion Multiphase	<1	<1	-	100

Notes: a) Au-Gold, Bn-Bornite, He-Hematite, Gn-Gangue
b) Mass data assumes particles are spherical in shape.

TABLE 7C
DISTRIBUTION OF GOLD OCCURRENCES BY CLASS OF ASSOCIATION
KM2543 Test 16 Pan Concentrate

Sample	Liberated	Locked in Binary With:			MP
		Bn	He	Gn	
Pan Concentrate	-	-	-	33	67

Notes: a) Bn-Bornite, He-Hematite, Gn-Gangue, MP-Multiphase.

TABLE 7D
DISTRIBUTION OF GOLD MASS BY CLASS OF ASSOCIATION
KM2543 Test 16 Pan Concentrate

Sample	Liberated				MP
		Bn	He	Gn	
Pan Concentrate	-	-	-	19	81

Notes: a) Bn-Bornite, He-Hematite, Gn-Gangue, MP-Multiphase.
b) Mass data assumes particles are spherical in shape.

TABLE 7E
SUMMARY OF ADIS ANALYSIS OF GOLD
KM2543 Test 16 Pan Concentrate

Parameter	Units
Size Fraction	Unsize
Number of Slides Scanned	25
Number of Particles Scanned	5.9×10^5
Total Surface Area of Particles	$4.0 \times 10^7 \mu\text{m}^2$
Total Surface Area of Gold	$77.1 \mu\text{m}^2$
Estimated Volume of All Particles	$1.6 \times 10^{11} \mu\text{m}^3$
Estimated Volume of Gold Grains	$299.1 \mu\text{m}^3$
Number of Gold Occurrences	3
Mean Projected Diameter of Gold	$5.7 \mu\text{m}$
Measured Gold Content	1.6 g/t

TABLE 7F
STATUS OF GOLD OCCURRENCES BY CLASS OF ASSOCIATION
KM2543 Test 16 Pan Concentrate

Particle	Mode of Occurrence	Projected Area Diameter - microns				Area % Gold
		Au	Bn	He	Gn	
1	Gold-Gangue Binary	5	-	39	123	<1
2	Gold Adhesion Multiphase	6	3	-	41	2
3	Gold Inclusion Multiphase	6	20	-	158	<1

Notes: a) Au-Gold, Bn-Bornite, He-Hematite, Gn-Gangue
b) Projected area diameter is the diameter of a circle in mineralogical terms.

TABLE 7G
STATUS OF GOLD OCCURRENCES BY MASS BY CLASS OF ASSOCIATION
KM2543 Test 16 Pan Concentrate

Particle	Mode of Occurrence	Mass - Percent			
		Au	Bn	He	Gn
1	Gold-Gangue Binary	<1	-	6	94
2	Gold Adhesion Multiphase	2	<1	-	98
3	Gold Inclusion Multiphase	<1	<1	-	100

Notes: a) Au-Gold, Bn-Bornite, He-Hematite, Gn-Gangue
b) Mass data assumes particles are spherical in shape.

PHOTOMICROGRAPH 6
RED CHRIS – PAN CONCENTRATE
KM2543 Test 16

Particle 1

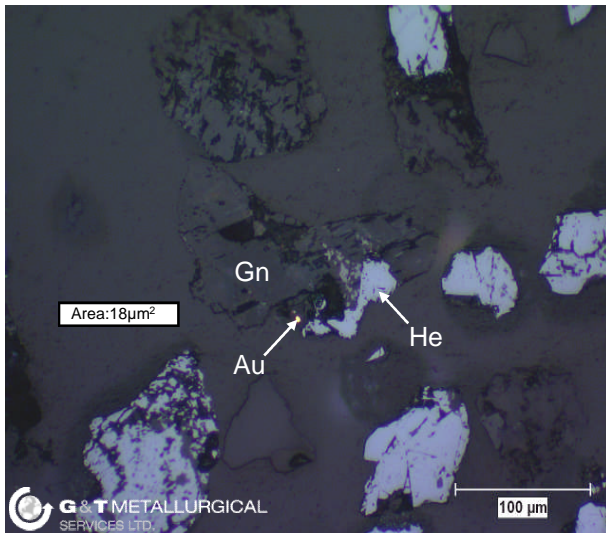

Particle 2

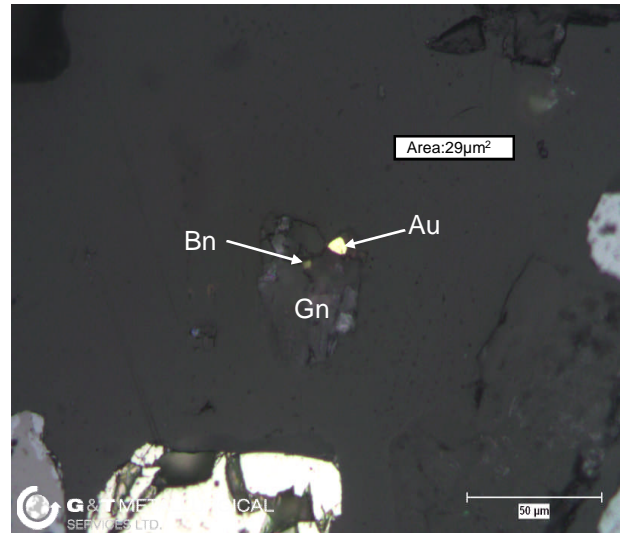

Particle 3

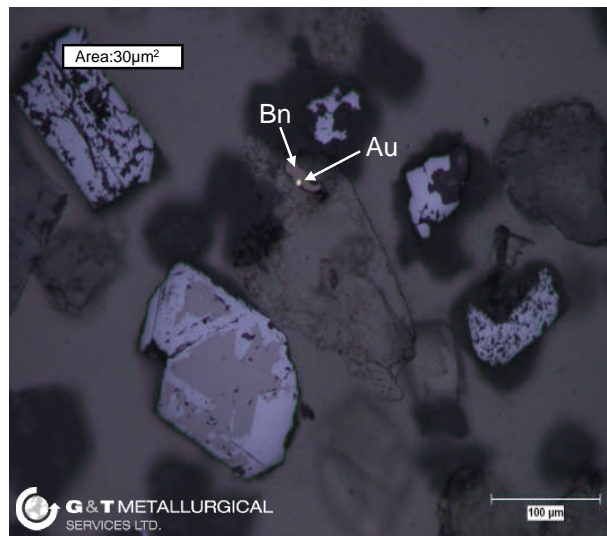

* Au-Gold, Bn-Bornite, He-Hematite, Gn-Gangue.